



ETA-Danmark A/S
Göteborg Plads 1
DK-2150 Nordhavn
Tel. +45 72 24 59 00
Fax +45 72 24 59 04
Internet www.etadanmark.dk

Authorised and notified
according to Article 29 of the
Regulation (EU)
No 305/2011 of the European
Parliament and of the Council
of 9 March 2011

MEMBER OF EOTA



European Technical Assessment ETA-09/0323 of 2021/08/17

I General Part

Technical Assessment Body issuing the ETA and designated according to Article 29 of the Regulation (EU) No 305/2011: ETA-Danmark A/S

Trade name of the construction product:

GH Angle Bracket types 5501S, 5502S, 6503S, 6503S13, 6504S, 6504S13, 9003S, 9004S, 9003SA4, 9004SA4, 5501SA4; 5502SA4, 6503SA4, 6504SA4, 9003SA4 and 9004SA4

Product family to which the above construction product belongs:

Three-dimensional nailing plate (Angle brackets for timber-to-timber or timber-to-concrete or steel connections)

Manufacturer:

GH-Baubeschläge GmbH
Austraße 34
D-73235 Weilheim/Teck
Tel. +49 7023 743323 0
Fax +49 7023 743323 90
Internet www.holzverbinder.de

Manufacturing plant:

Werk 1, Werk 2

This European Technical Assessment contains:

204 pages including 2 annexes which form an integral part of the document

This European Technical Assessment is issued in accordance with Regulation (EU) No 305/2011, on the basis of:

EAD 130186-00-0603 Three dimensional nailing plates

This version replaces:

The previous ETA with the same number issued on 2020-06-15

Translations of this European Technical Assessment in other languages shall fully correspond to the original issued document and should be identified as such.

Communication of this European Technical Assessment, including transmission by electronic means, shall be in full (excepted the confidential Annex(es) referred to above). However, partial reproduction may be made, with the written consent of the issuing Technical Assessment Body. Any partial reproduction has to be identified as such.

TABLE OF CONTENTS

II	SPECIFIC PART OF THE EUROPEAN TECHNICAL ASSESSMENT	8
1	Technical description of product and intended use	8
2	Specification of the intended use in accordance with the applicable EAD	8
3	Performance of the product and references to the methods used for its assessment	9
3.1	Mechanical resistance and stability*) (BWR1)	9
3.2	Safety in case of fire (BWR2)	9
3.3	General aspects related to the performance of the product	9
3.9	Methods of verification	10
3.10	Mechanical resistance and stability	10
3.11	Aspects related to the performance of the product	11
3.12	General aspects related to the fitness for use of the product	11
4	Attestation and verification of constancy of performance (AVCP)	12
4.1	AVCP system	12
5	Technical details necessary for the implementation of the AVCP system, as foreseen in the applicable EAD	12
	Annex A.....	13
	Product details and definitions	13
	Annex B.....	24
	Characteristic load-carrying capacities	24
	Single angle bracket per connection.....	25
	Double angle brackets per connection	25
	Permitted load directions	25
	Proof of load-carrying capacities a single force acting in one direction	25
	Proof of load-carrying capacities for combined forces	26
	Wane	26
	Timber splitting.....	26
	Fastening pattern	26
	Interlayer	28
	Connection to steel or concrete elements with bolts or metal anchors.....	28
	Load-capacity values.....	28

LIST OF FIGURES AND TABLES

Figure A. 1	Dimensions of Angle Brackets 5501S and 5501SA4	14
Figure A. 2	Dimensions of Angle Brackets 5502S and 5502SA4	15
Figure A. 3	Dimensions of Angle Brackets 6503S and 6503SA4	16
Figure A. 4	Dimensions of Angle Bracket 6503S13.....	17
Figure A. 5	Dimensions of Angle Brackets 6504S and 6504SA4	18
Figure A. 6	Dimensions of Angle Bracket 6504S13.....	19
Figure A. 7	Dimensions of Angle Bracket 9003S.....	20
Figure A. 8	Dimensions of Angle Bracket 9004S.....	21
Figure A. 9	Dimensions of Angle Bracket 9003SA4.....	22
Figure A. 10	Dimensions of Angle Bracket 9004SA4	23
Table A. 1	Materials specification	13
Table A. 2	Range of sizes	13
Table A. 3	Fastener specification.....	13
Figure B. 1	Definitions of forces, their directions and eccentricity forces - Beam to beam connection.....	24
Figure B. 2	Definition of lever arms for forced with eccentricity.....	25
Table B. 1	Fastening pattern and permitted load directions	27
Table B. 2	Angle bracket type 5501S, Variant TCM, Fastener GH Nail 4x40, Density 350 kg/m ³	29
Table B. 3	Angle bracket type 5501S, Variant TCM, Fastener GH Nail 4x60, Density 350 kg/m ³	30
Table B. 4	Angle bracket type 5501S, Variant TCM, Fastener GH Screw 5x40, Density 350 kg/m ³	31
Table B. 5	Angle bracket type 5501S, Variant TCM, Fastener GH Screw 5x60, Density 350 kg/m ³	32
Table B. 6	Angle bracket type 5501S, Variant TCP, Fastener GH Nail 4x40, Density 350 kg/m ³	33
Table B. 7	Angle bracket type 5501S, Variant TCP, Fastener GH Nail 4x60, Density 350 kg/m ³	34
Table B. 8	Angle bracket type 5501S, Variant TCP, Fastener GH Screw 5x40, Density 350 kg/m ³	35
Table B. 9	Angle bracket type 5501S, Variant TCP, Fastener GH Screw 5x60, Density 350 kg/m ³	36
Table B. 10	Angle bracket type 5501S, Variant TTM, Fastener GH Nail 4x40, Density 350 kg/m ³	37
Table B. 11	Angle bracket type 5501S, Variant TTM, Fastener GH Nail 4x60, Density 350 kg/m ³	38
Table B. 12	Angle bracket type 5501S, Variant TTM, Fastener GH Screw 5x40, Density 350 kg/m ³	39
Table B. 13	Angle bracket type 5501S, Variant TTM, Fastener GH Screw 5x60, Density 350 kg/m ³	40
Table B. 14	Angle bracket type 5501S, Variant TTP, Fastener GH Nail 4x40, Density 350 kg/m ³	41
Table B. 15	Angle bracket type 5501S, Variant TTP, Fastener GH Nail 4x60, Density 350 kg/m ³	42
Table B. 16	Angle bracket type 5501S, Variant TTP, Fastener GH Screw 5x40, Density 350 kg/m ³	43
Table B. 17	Angle bracket type 5501S, Variant TTP, Fastener GH Screw 5x60, Density 350 kg/m ³	44
Table B. 18	Angle bracket type 5502S, Variant TCM, Fastener GH Nail 4x40, Density 350 kg/m ³	45
Table B. 19	Angle bracket type 5502S, Variant TCM, Fastener GH Nail 4x60, Density 350 kg/m ³	46
Table B. 20	Angle bracket type 5502S, Variant TCM, Fastener GH Screw 5x40, Density 350 kg/m ³	47
Table B. 21	Angle bracket type 5502S, Variant TCM, Fastener GH Screw 5x60, Density 350 kg/m ³	48
Table B. 22	Angle bracket type 5502S, Variant TCP, Fastener GH Nail 4x40, Density 350 kg/m ³	49
Table B. 23	Angle bracket type 5502S, Variant TCP, Fastener GH Nail 4x60, Density 350 kg/m ³	50
Table B. 24	Angle bracket type 5502S, Variant TCP, Fastener GH Screw 5x40, Density 350 kg/m ³	51
Table B. 25	Angle bracket type 5502S, Variant TCP, Fastener GH Screw 5x60, Density 350 kg/m ³	52
Table B. 26	Angle bracket type 5502S, Variant TTM, Fastener GH Nail 4x40, Density 350 kg/m ³	53
Table B. 27	Angle bracket type 5502S, Variant TTM, Fastener GH Nail 4x60, Density 350 kg/m ³	54
Table B. 28	Angle bracket type 5502S, Variant TTM, Fastener GH Screw 5x40, Density 350 kg/m ³	55
Table B. 29	Angle bracket type 5502S, Variant TTM, Fastener GH Screw 5x60, Density 350 kg/m ³	56
Table B. 30	Angle bracket type 5502S, Variant TTP, Fastener GH Nail 4x40, Density 350 kg/m ³	57
Table B. 31	Angle bracket type 5502S, Variant TTP, Fastener GH Nail 4x60, Density 350 kg/m ³	58
Table B. 32	Angle bracket type 5502S, Variant TTP, Fastener GH Screw 5x40, Density 350 kg/m ³	59

Table B. 33	Angle bracket type	5502S, Variant	TTP, Fastener	GH Screw 5x60, Density	350 kg/m ³	60
Table B. 34	Angle bracket type	6503S, Variant	TCM, Fastener	GH Nail 4x40, Density	350 kg/m ³	61
Table B. 35	Angle bracket type	6503S, Variant	TCM, Fastener	GH Nail 4x60, Density	350 kg/m ³	62
Table B. 36	Angle bracket type	6503S, Variant	TCM, Fastener	GH Screw 5x40, Density	350 kg/m ³	63
Table B. 37	Angle bracket type	6503S, Variant	TCM, Fastener	GH Screw 5x60, Density	350 kg/m ³	64
Table B. 38	Angle bracket type	6503S, Variant	TCP, Fastener	GH Nail 4x40, Density	350 kg/m ³	65
Table B. 39	Angle bracket type	6503S, Variant	TCP, Fastener	GH Nail 4x60, Density	350 kg/m ³	66
Table B. 40	Angle bracket type	6503S, Variant	TCP, Fastener	GH Screw 5x40, Density	350 kg/m ³	67
Table B. 41	Angle bracket type	6503S, Variant	TCP, Fastener	GH Screw 5x60, Density	350 kg/m ³	68
Table B. 42	Angle bracket type	6503S, Variant	TTM, Fastener	GH Nail 4x40, Density	350 kg/m ³	69
Table B. 43	Angle bracket type	6503S, Variant	TTM, Fastener	GH Nail 4x60, Density	350 kg/m ³	70
Table B. 44	Angle bracket type	6503S, Variant	TTM, Fastener	GH Screw 5x40, Density	350 kg/m ³	71
Table B. 45	Angle bracket type	6503S, Variant	TTM, Fastener	GH Screw 5x60, Density	350 kg/m ³	72
Table B. 46	Angle bracket type	6503S, Variant	TTP, Fastener	GH Nail 4x40, Density	350 kg/m ³	73
Table B. 47	Angle bracket type	6503S, Variant	TTP, Fastener	GH Nail 4x60, Density	350 kg/m ³	74
Table B. 48	Angle bracket type	6503S, Variant	TTP, Fastener	GH Screw 5x40, Density	350 kg/m ³	75
Table B. 49	Angle bracket type	6503S, Variant	TTP, Fastener	GH Screw 5x60, Density	350 kg/m ³	76
Table B. 50	Angle bracket type	6503S13, Variant	TCM, Fastener	GH Nail 4x40, Density	350 kg/m ³	77
Table B. 51	Angle bracket type	6503S13, Variant	TCM, Fastener	GH Nail 4x60, Density	350 kg/m ³	78
Table B. 52	Angle bracket type	6503S13, Variant	TCM, Fastener	GH Screw 5x40, Density	350 kg/m ³	79
Table B. 53	Angle bracket type	6503S13, Variant	TCM, Fastener	GH Screw 5x60, Density	350 kg/m ³	80
Table B. 54	Angle bracket type	6503S13, Variant	TCP, Fastener	GH Nail 4x40, Density	350 kg/m ³	81
Table B. 55	Angle bracket type	6503S13, Variant	TCP, Fastener	GH Nail 4x60, Density	350 kg/m ³	82
Table B. 56	Angle bracket type	6503S13, Variant	TCP, Fastener	GH Screw 5x40, Density	350 kg/m ³	83
Table B. 57	Angle bracket type	6503S13, Variant	TCP, Fastener	GH Screw 5x60, Density	350 kg/m ³	84
Table B. 58	Angle bracket type	6503S13, Variant	TTM, Fastener	GH Nail 4x40, Density	350 kg/m ³	85
Table B. 59	Angle bracket type	6503S13, Variant	TTM, Fastener	GH Nail 4x60, Density	350 kg/m ³	86
Table B. 60	Angle bracket type	6503S13, Variant	TTM, Fastener	GH Screw 5x40, Density	350 kg/m ³	87
Table B. 61	Angle bracket type	6503S13, Variant	TTM, Fastener	GH Screw 5x60, Density	350 kg/m ³	88
Table B. 62	Angle bracket type	6503S13, Variant	TTP, Fastener	GH Nail 4x40, Density	350 kg/m ³	89
Table B. 63	Angle bracket type	6503S13, Variant	TTP, Fastener	GH Nail 4x60, Density	350 kg/m ³	90
Table B. 64	Angle bracket type	6503S13, Variant	TTP, Fastener	GH Screw 5x40, Density	350 kg/m ³	91
Table B. 65	Angle bracket type	6503S13, Variant	TTP, Fastener	GH Screw 5x60, Density	350 kg/m ³	92
Table B. 66	Angle bracket type	6504S, Variant	TCM, Fastener	GH Nail 4x40, Density	350 kg/m ³	93
Table B. 67	Angle bracket type	6504S, Variant	TCM, Fastener	GH Nail 4x60, Density	350 kg/m ³	94
Table B. 68	Angle bracket type	6504S, Variant	TCM, Fastener	GH Screw 5x40, Density	350 kg/m ³	95
Table B. 69	Angle bracket type	6504S, Variant	TCM, Fastener	GH Screw 5x60, Density	350 kg/m ³	96
Table B. 70	Angle bracket type	6504S, Variant	TCP, Fastener	GH Nail 4x40, Density	350 kg/m ³	97
Table B. 71	Angle bracket type	6504S, Variant	TCP, Fastener	GH Nail 4x60, Density	350 kg/m ³	98
Table B. 72	Angle bracket type	6504S, Variant	TCP, Fastener	GH Screw 5x40, Density	350 kg/m ³	99
Table B. 73	Angle bracket type	6504S, Variant	TCP, Fastener	GH Screw 5x60, Density	350 kg/m ³	100
Table B. 74	Angle bracket type	6504S, Variant	TTM, Fastener	GH Nail 4x40, Density	350 kg/m ³	101
Table B. 75	Angle bracket type	6504S, Variant	TTM, Fastener	GH Nail 4x60, Density	350 kg/m ³	102
Table B. 76	Angle bracket type	6504S, Variant	TTM, Fastener	GH Screw 5x40, Density	350 kg/m ³	103
Table B. 77	Angle bracket type	6504S, Variant	TTM, Fastener	GH Screw 5x60, Density	350 kg/m ³	104
Table B. 78	Angle bracket type	6504S, Variant	TTP, Fastener	GH Nail 4x40, Density	350 kg/m ³	105
Table B. 79	Angle bracket type	6504S, Variant	TTP, Fastener	GH Nail 4x60, Density	350 kg/m ³	106
Table B. 80	Angle bracket type	6504S, Variant	TTP, Fastener	GH Screw 5x40, Density	350 kg/m ³	107
Table B. 81	Angle bracket type	6504S, Variant	TTP, Fastener	GH Screw 5x60, Density	350 kg/m ³	108
Table B. 82	Angle bracket type	6504S13, Variant	TCM, Fastener	GH Nail 4x40, Density	350 kg/m ³	109
Table B. 83	Angle bracket type	6504S13, Variant	TCM, Fastener	GH Nail 4x60, Density	350 kg/m ³	110
Table B. 84	Angle bracket type	6504S13, Variant	TCM, Fastener	GH Screw 5x40, Density	350 kg/m ³	111
Table B. 85	Angle bracket type	6504S13, Variant	TCM, Fastener	GH Screw 5x60, Density	350 kg/m ³	112

Table B. 86	Angle bracket type 6504S13, Variant TCP, Fastener GH Nail 4x40, Density 350 kg/m ³	113
Table B. 87	Angle bracket type 6504S13, Variant TCP, Fastener GH Nail 4x60, Density 350 kg/m ³	114
Table B. 88	Angle bracket type 6504S13, Variant TCP, Fastener GH Screw 5x40, Density 350 kg/m ³	115
Table B. 89	Angle bracket type 6504S13, Variant TCP, Fastener GH Screw 5x60, Density 350 kg/m ³	116
Table B. 90	Angle bracket type 6504S13, Variant TTM, Fastener GH Nail 4x40, Density 350 kg/m ³	117
Table B. 91	Angle bracket type 6504S13, Variant TTM, Fastener GH Nail 4x60, Density 350 kg/m ³	118
Table B. 92	Angle bracket type 6504S13, Variant TTM, Fastener GH Screw 5x40, Density 350 kg/m ³	119
Table B. 93	Angle bracket type 6504S13, Variant TTM, Fastener GH Screw 5x60, Density 350 kg/m ³	120
Table B. 94	Angle bracket type 6504S13, Variant TTP, Fastener GH Nail 4x40, Density 350 kg/m ³	121
Table B. 95	Angle bracket type 6504S13, Variant TTP, Fastener GH Nail 4x60, Density 350 kg/m ³	122
Table B. 96	Angle bracket type 6504S13, Variant TTP, Fastener GH Screw 5x40, Density 350 kg/m ³	123
Table B. 97	Angle bracket type 6504S13, Variant TTP, Fastener GH Screw 5x60, Density 350 kg/m ³	124
Table B. 98	Angle bracket type 9003S, Variant TCM, Fastener GH Nail 4x40, Density 350 kg/m ³	125
Table B. 99	Angle bracket type 9003S, Variant TCM, Fastener GH Nail 4x60, Density 350 kg/m ³	126
Table B. 100	Angle bracket type 9003S, Variant TCM, Fastener GH Screw 5x40, Density 350 kg/m ³	127
Table B. 101	Angle bracket type 9003S, Variant TCM, Fastener GH Screw 5x60, Density 350 kg/m ³	128
Table B. 102	Angle bracket type 9003S, Variant TCP, Fastener GH Nail 4x40, Density 350 kg/m ³	129
Table B. 103	Angle bracket type 9003S, Variant TCP, Fastener GH Nail 4x60, Density 350 kg/m ³	130
Table B. 104	Angle bracket type 9003S, Variant TCP, Fastener GH Screw 5x40, Density 350 kg/m ³	131
Table B. 105	Angle bracket type 9003S, Variant TCP, Fastener GH Screw 5x60, Density 350 kg/m ³	132
Table B. 106	Angle bracket type 9003S, Variant TTM, Fastener GH Nail 4x40, Density 350 kg/m ³	133
Table B. 107	Angle bracket type 9003S, Variant TTM, Fastener GH Nail 4x60, Density 350 kg/m ³	134
Table B. 108	Angle bracket type 9003S, Variant TTM, Fastener GH Screw 5x40, Density 350 kg/m ³	135
Table B. 109	Angle bracket type 9003S, Variant TTM, Fastener GH Screw 5x60, Density 350 kg/m ³	136
Table B. 110	Angle bracket type 9003S, Variant TTP, Fastener GH Nail 4x40, Density 350 kg/m ³	137
Table B. 111	Angle bracket type 9003S, Variant TTP, Fastener GH Nail 4x60, Density 350 kg/m ³	138
Table B. 112	Angle bracket type 9003S, Variant TTP, Fastener GH Screw 5x40, Density 350 kg/m ³	139
Table B. 113	Angle bracket type 9003S, Variant TTP, Fastener GH Screw 5x60, Density 350 kg/m ³	140
Table B. 114	Angle bracket type 9004S, Variant TCM, Fastener GH Nail 4x40, Density 350 kg/m ³	141
Table B. 115	Angle bracket type 9004S, Variant TCM, Fastener GH Nail 4x60, Density 350 kg/m ³	142
Table B. 116	Angle bracket type 9004S, Variant TCM, Fastener GH Screw 5x40, Density 350 kg/m ³	143
Table B. 117	Angle bracket type 9004S, Variant TCM, Fastener GH Screw 5x60, Density 350 kg/m ³	144
Table B. 118	Angle bracket type 9004S, Variant TCP, Fastener GH Nail 4x40, Density 350 kg/m ³	145
Table B. 119	Angle bracket type 9004S, Variant TCP, Fastener GH Nail 4x60, Density 350 kg/m ³	146
Table B. 120	Angle bracket type 9004S, Variant TCP, Fastener GH Screw 5x40, Density 350 kg/m ³	147
Table B. 121	Angle bracket type 9004S, Variant TCP, Fastener GH Screw 5x60, Density 350 kg/m ³	148
Table B. 122	Angle bracket type 9004S, Variant TTM, Fastener GH Nail 4x40, Density 350 kg/m ³	149
Table B. 123	Angle bracket type 9004S, Variant TTM, Fastener GH Nail 4x60, Density 350 kg/m ³	150
Table B. 124	Angle bracket type 9004S, Variant TTM, Fastener GH Screw 5x40, Density 350 kg/m ³	151
Table B. 125	Angle bracket type 9004S, Variant TTM, Fastener GH Screw 5x60, Density 350 kg/m ³	152
Table B. 126	Angle bracket type 9004S, Variant TTP, Fastener GH Nail 4x40, Density 350 kg/m ³	153
Table B. 127	Angle bracket type 9004S, Variant TTP, Fastener GH Nail 4x60, Density 350 kg/m ³	154
Table B. 128	Angle bracket type 9004S, Variant TTP, Fastener GH Screw 5x40, Density 350 kg/m ³	155
Table B. 129	Angle bracket type 9004S, Variant TTP, Fastener GH Screw 5x60, Density 350 kg/m ³	156
Table B. 130	Angle bracket type 5501SA4, Variant TCM, Fastener Profiled nail A4 4x40, Density 350 kg/m ³	157
Table B. 131	Angle bracket type 5501SA4, Variant TCM, Fastener Profiled nail A4 4x60, Density 350 kg/m ³	158
Table B. 132	Angle bracket type 5501SA4, Variant TCP, Fastener Profiled nail A4 4x40, Density 350 kg/m ³	159
Table B. 133	Angle bracket type 5501SA4, Variant TCP, Fastener Profiled nail A4 4x60, Density 350 kg/m ³	160
Table B. 134	Angle bracket type 5501SA4, Variant TTM, Fastener Profiled nail A4 4x40, Density 350 kg/m ³	161
Table B. 135	Angle bracket type 5501SA4, Variant TTM, Fastener Profiled nail A4 4x60, Density 350 kg/m ³	162
Table B. 136	Angle bracket type 5501SA4, Variant TTP, Fastener Profiled nail A4 4x40, Density 350 kg/m ³	163
Table B. 137	Angle bracket type 5501SA4, Variant TTP, Fastener Profiled nail A4 4x60, Density 350 kg/m ³	164
Table B. 138	Angle bracket type 5502SA4, Variant TCM, Fastener Profiled nail A4 4x40, Density 350 kg/m ³	165

Table B. 139	Angle bracket type	5502SA4, Variant	TCM, Fastener	Profiled nail A4 4x60, Density	350 kg/m ³	166
Table B. 140	Angle bracket type	5502SA4, Variant	TCP, Fastener	Profiled nail A4 4x40, Density	350 kg/m ³	167
Table B. 141	Angle bracket type	5502SA4, Variant	TCP, Fastener	Profiled nail A4 4x60, Density	350 kg/m ³	168
Table B. 142	Angle bracket type	5502SA4, Variant	TTM, Fastener	Profiled nail A4 4x40, Density	350 kg/m ³	169
Table B. 143	Angle bracket type	5502SA4, Variant	TTM, Fastener	Profiled nail A4 4x60, Density	350 kg/m ³	170
Table B. 144	Angle bracket type	5502SA4, Variant	TTP, Fastener	Profiled nail A4 4x40, Density	350 kg/m ³	171
Table B. 145	Angle bracket type	5502SA4, Variant	TTP, Fastener	Profiled nail A4 4x60, Density	350 kg/m ³	172
Table B. 146	Angle bracket type	6503SA4, Variant	TCM, Fastener	Profiled nail A4 4x40, Density	350 kg/m ³	173
Table B. 147	Angle bracket type	6503SA4, Variant	TCM, Fastener	Profiled nail A4 4x60, Density	350 kg/m ³	174
Table B. 148	Angle bracket type	6503SA4, Variant	TCP, Fastener	Profiled nail A4 4x40, Density	350 kg/m ³	175
Table B. 149	Angle bracket type	6503SA4, Variant	TCP, Fastener	Profiled nail A4 4x60, Density	350 kg/m ³	176
Table B. 150	Angle bracket type	6503SA4, Variant	TTM, Fastener	Profiled nail A4 4x40, Density	350 kg/m ³	177
Table B. 151	Angle bracket type	6503SA4, Variant	TTM, Fastener	Profiled nail A4 4x60, Density	350 kg/m ³	178
Table B. 152	Angle bracket type	6503SA4, Variant	TTP, Fastener	Profiled nail A4 4x40, Density	350 kg/m ³	179
Table B. 153	Angle bracket type	6503SA4, Variant	TTP, Fastener	Profiled nail A4 4x60, Density	350 kg/m ³	180
Table B. 154	Angle bracket type	6504SA4, Variant	TCM, Fastener	Profiled nail A4 4x40, Density	350 kg/m ³	181
Table B. 155	Angle bracket type	6504SA4, Variant	TCM, Fastener	Profiled nail A4 4x60, Density	350 kg/m ³	182
Table B. 156	Angle bracket type	6504SA4, Variant	TCP, Fastener	Profiled nail A4 4x40, Density	350 kg/m ³	183
Table B. 157	Angle bracket type	6504SA4, Variant	TCP, Fastener	Profiled nail A4 4x60, Density	350 kg/m ³	184
Table B. 158	Angle bracket type	6504SA4, Variant	TTM, Fastener	Profiled nail A4 4x40, Density	350 kg/m ³	185
Table B. 159	Angle bracket type	6504SA4, Variant	TTM, Fastener	Profiled nail A4 4x60, Density	350 kg/m ³	186
Table B. 160	Angle bracket type	6504SA4, Variant	TTP, Fastener	Profiled nail A4 4x40, Density	350 kg/m ³	187
Table B. 161	Angle bracket type	6504SA4, Variant	TTP, Fastener	Profiled nail A4 4x60, Density	350 kg/m ³	188
Table B. 162	Angle bracket type	9003SA4, Variant	TCM, Fastener	Profiled nail A4 4x40, Density	350 kg/m ³	189
Table B. 163	Angle bracket type	9003SA4, Variant	TCM, Fastener	Profiled nail A4 4x60, Density	350 kg/m ³	190
Table B. 164	Angle bracket type	9003SA4, Variant	TCP, Fastener	Profiled nail A4 4x40, Density	350 kg/m ³	191
Table B. 165	Angle bracket type	9003SA4, Variant	TCP, Fastener	Profiled nail A4 4x60, Density	350 kg/m ³	192
Table B. 166	Angle bracket type	9003SA4, Variant	TTM, Fastener	Profiled nail A4 4x40, Density	350 kg/m ³	193
Table B. 167	Angle bracket type	9003SA4, Variant	TTM, Fastener	Profiled nail A4 4x60, Density	350 kg/m ³	194
Table B. 168	Angle bracket type	9003SA4, Variant	TTP, Fastener	Profiled nail A4 4x40, Density	350 kg/m ³	195
Table B. 169	Angle bracket type	9003SA4, Variant	TTP, Fastener	Profiled nail A4 4x60, Density	350 kg/m ³	196
Table B. 170	Angle bracket type	9004SA4, Variant	TCM, Fastener	Profiled nail A4 4x40, Density	350 kg/m ³	197
Table B. 171	Angle bracket type	9004SA4, Variant	TCM, Fastener	Profiled nail A4 4x60, Density	350 kg/m ³	198
Table B. 172	Angle bracket type	9004SA4, Variant	TCP, Fastener	Profiled nail A4 4x40, Density	350 kg/m ³	199
Table B. 173	Angle bracket type	9004SA4, Variant	TCP, Fastener	Profiled nail A4 4x60, Density	350 kg/m ³	200
Table B. 174	Angle bracket type	9004SA4, Variant	TTM, Fastener	Profiled nail A4 4x40, Density	350 kg/m ³	201
Table B. 175	Angle bracket type	9004SA4, Variant	TTM, Fastener	Profiled nail A4 4x60, Density	350 kg/m ³	202
Table B. 176	Angle bracket type	9004SA4, Variant	TTP, Fastener	Profiled nail A4 4x40, Density	350 kg/m ³	203
Table B. 177	Angle bracket type	9004SA4, Variant	TTP, Fastener	Profiled nail A4 4x60, Density	350 kg/m ³	204

II SPECIFIC PART OF THE EUROPEAN TECHNICAL ASSESSMENT

1 Technical description of product and intended use

Technical description of the product

GH Baubeschläge GmbH various angle brackets covers the following bracket types:

5501S, 5502S, 6503S, 6503S13, 6504S, 6504S13, 9003S, 9004S, 5501SA4, 5502SA4, 6503SA4, 6504SA4, 9003SA4 and 9004SA4.

They are one-piece non-welded, face-fixed angle brackets to be used in timber to timber, timber to steel and timber to concrete connections. They are connected to the timber elements by a range of profiled nails, connector screws or bolts.

The angle brackets 5501S, 5502S, 6503S, 6503S13, 6504S, 6504S13, 9003S and 9004S are made from pre-galvanized steel S 250 GD + Z275, S 235 JR + Z275 or DX 51 D + Z275 according to EN 10346:2009 with a minimum yield stress of 235 MPa, a minimum tensile strength R_m of 330 MPa and a minimum ultimate strain A80 of 22 % and are available with or without an embossed rib. Additionally, this angle brackets can be made from stainless steel 1.4301, 1.4401, 1.4541 or 1.4571 according to EN 10088-2:2005 with a minimum yield stress of 190 MPa. For using the load-carrying capacity tables in Annex B, for angle brackets made from stainless steel, the characteristic steel load-carrying capacity, in rows marked by "S", must be multiplied with the factor 0,80. This compensates the difference in yield strength between the listed stainless steels and the standard material of the angle brackets. The characteristic embedding strength $f_{h,k}$, the characteristic withdrawal parameter $f_{ax,k}$ and the characteristic yield moment $M_{y,k}$ of the fasteners, which must be made from stainless steel, must be equal or higher than those of the fasteners used in the load-carrying capacity tables.

The angle brackets 5501SA4, 5502SA4, 6503SA4, 6504SA4, 9003SA4 and 9004SA4 are made from stainless steel 1.4571 according to EN 10088-2:2005 with a minimum yield stress of 220 MPa and are available with or without an embossed rib.

Dimensions, hole positions and typical installations are shown in Annex A.

2 Specification of the intended use in accordance with the applicable EAD

The angle brackets are intended for use in making connections in load bearing timber structures, as a connection between two timber components or between a timber component and a steel or concrete component, where requirements for mechanical resistance and stability and safety in use in the sense of the Basic Works

Requirements 1 and 4 of Regulation (EU) 305/2011 shall be fulfilled.

Connections of angle brackets to timber members with interlayers between the angle bracket and the timber member are possible. The influence of the interlayer on the load capacity has to be considered.

The connection may be with a single angle bracket or with an angle bracket on each side of the fastened timber member (see Annex A).

The wood members can be of solid timber, glued laminated timber and similar glued members, or wood-based structural members according to EN 1995-1-1 or a European Technical Assessment.

For connections to timber components, the connectors can be profiled nails with diameter 4 mm or connector screws with diameter 5 mm according to EN 14592 or a European Technical Assessment.

For connections to steel or concrete elements, bolts whose dimensioning is based on EN 1993 or metal anchors according to a European Technical Assessment can be used.

Annex B states the characteristic values of the load-carrying capacities of angle bracket connections with GH ring shanked nails and GH screws for a characteristic density of $\rho_k = 350 \text{ kg/m}^3$. For other connectors the load-carrying capacities of angle bracket connections have to be calculated with the load-carrying capacities of the used fasteners.

The design of the connections shall be in accordance with EN 1995 or a similar national Timber Code. The wood members shall have a thickness, which is larger than the penetration depth of the nails into the members.

The angle brackets are primarily for use in timber structures subject to the dry, internal conditions defined by service class 1 and 2 of EN 1995-1-1 and for connections subject to static or quasi-static loading. For use in service class 3 of EN 1995-1-1 the angle brackets, profiled nails and connector screws shall be produced from stainless steel.

The scope of the brackets regarding resistance to corrosion shall be defined according to national provisions that apply at the installation site considering environmental conditions.

The provisions made in this European Technical Assessment are based on an assumed intended working life of the connectors of 50 years.

The indications given on the working life cannot be interpreted as a guarantee given by the producer or Assessment Body, but are to be regarded only as a means for choosing the right products in relation to the expected economically reasonable working life of the works.

3 Performance of the product and references to the methods used for its assessment

Characteristic	Assessment of characteristic
3.1 Mechanical resistance and stability*) (BWR1)	
Characteristic load-carrying capacity	See Annex B
Stiffness	No performance assessed
Ductility in cyclic testing	No performance assessed
3.2 Safety in case of fire (BWR2)	
Reaction to fire	The angle brackets are made from steel classified as Euroclass A1 in accordance with EN 1350-1 and EC decision 96/603/EC, amended by EC Decision 2000/605/EC
3.3 General aspects related to the performance of the product	
	The angle brackets have been assessed as having satisfactory durability and serviceability when used in timber structures using the timber species described in Eurocode 5 and subject to the conditions defined by service class 1, 2 and 3 Identification See Annex A
Identification	See Annex A

*) See additional information in section 3.4 - 3.5.

3.9 Methods of verification

The characteristic load-carrying capacities of connections with angle brackets are based on the characteristic values of the connectors and the steel plates.

According to EN 1990 (Eurocode - Basis of design) paragraph 6.3.5 the design value of load-carrying capacity can be determined by reducing the characteristic values of the load-carrying capacity with different partial factors.

Therefore, to obtain design values according to the Eurocodes or appropriate national codes of practice, the capacities have to be multiplied with different partial factors for the material properties and - for the connectors mounted in wood - also the coefficient k_{mod} according to EN 1995-1-1 that takes into account the load duration class and the service class.

Thus, the characteristic values of the load-carrying capacity are determined also for timber failure $F_{Rk,T}$ (obtaining the embedment strength of connectors subjected to shear or the withdrawal capacity of the most loaded connector, respectively) as well as for steel plate failure $F_{Rk,S}$. The design value of the load-carrying capacity is the smaller value of both load-carrying capacities.

$$F_{Rd} = \min \{ k_{mod} \cdot F_{Rk,T} / \gamma_{M,T} ; F_{Rk,S} / \gamma_{M,S} \} \quad (1)$$

Therefore, for timber failure the load duration class and the service class are included. The different partial factors γ_M for steel or timber, respectively, are taken into account in formula (1).

3.10 Mechanical resistance and stability

See Annex B for the principal definition of the load-carrying capacities F_1 to F_5 and the verification of the load-carrying capacity.

The characteristic capacities of the angle brackets are partially determined by calculation assisted by testing as described in the EAD 130186-00-0603. They should be used for designs in accordance with Eurocode 5 or a similar national Timber Code.

The characteristic load-carrying capacities in Annex B are valid for GH ring shanked nails 4x40, 4x60 and GH screws 5x40, 5x60 according to ETA-13/0523 for an characteristic density of the timber element $\rho_k \geq 350 \text{ kg/m}^3$.

The characteristic load-carrying capacity of the angle brackets in combination with other lengths of the nails or screws and/or another density of the timber element can be calculated separately, taking into account the underlying failure mechanisms.

The shape of the nail and the screw directly under the head shall be in the form of a truncated cone with a diameter under the nail head which exceeds the hole diameter.

For the calculation of the lateral load-carrying capacity $R_{l,k}$ of profiled nails or connector screws according to EN 1995, a thick steel plate can be assumed under the following conditions:

- fasteners according to EN 14592 and thickness of the steel plate $t \geq 2 \text{ mm}$,
- fasteners according to ETA-13/0523 and thickness of the steel plate $t \geq 1,5 \text{ mm}$.

Depending on the hole diameter, the angle brackets can be fastened to concrete or steel member by bolts or metal anchors with a diameter of 10 mm or 12 mm.

No performance has been determined in relation to ductility of a joint under cyclic testing. The contribution to the performance of structures in seismic zones, therefore, has not been assessed.

No performance has been determined in relation to the joint's stiffness properties - to be used for the analysis of the serviceability limit state.

Axial load-carrying capacity of profiled nails or connector screws in accordance to EN 14592

The characteristic axial withdrawal capacity $F_{ax,Rk}$ of the nails has to be determined by calculation in accordance with EN 1995-1-1: 2010-12, 8.3.2. Head pull-through is not relevant.

$$F_{ax,Rk} = f_{ax,k} \cdot d \cdot t_{pen} \quad (2)$$

where

$f_{ax,k}$ Characteristic value of the withdrawal parameter in N/mm^2 ,

d Nail diameter in mm,

t_{pen} Penetration length of the profile shank in mm. The specifications according to EN 1995 or ETA shall be complied with.

If no characteristic value of the withdrawal resistance for the threaded nails used is declared in the ETA, it can be calculated as below.

Based on tests by Versuchsanstalt für Stahl, Holz und Steine, University of Karlsruhe, the characteristic value of the withdrawal resistance for the threaded nails used can be calculated as:

$$f_{ax,k} = 50 \cdot 10^{-6} \cdot \rho_k^2 \quad (3)$$

where

ρ_k Characteristic density of the timber in kg/m^3 .

3.11 Aspects related to the performance of the product

3.11.1 Corrosion protection in service class 1 and 2. In accordance with EAD 130186-00-0603 the angle brackets are made from pre-galvanized steel S 250 GD + Z275, S 235 JR + Z275 or DX 51 D + Z275 according to EN 10346:2009.

3.11.2 Corrosion protection in service class 3. In accordance with Eurocode 5 the angle brackets are made from stainless steel 1.4301, 1.4401, 1.4541 or 1.4571 according to EN 10088-2:2005 and the nails and screws shall be produced from stainless steel.

3.12 General aspects related to the fitness for use of the product

GH angle brackets are manufactured in accordance with the provisions of this European Technical Assessment using the manufacturing processes as identified in the inspection of the plant by the notified inspection body and laid down in the technical documentation.

The fastening pattern used shall be either the maximum or the partial pattern as defined in Annex A. There shall be fasteners in at least all holes defined in Annex A.

The edge and end distances in accordance with Eurocode 5 or an appropriate national code shall be complied with.

The angle bracket connection shall be designed in accordance with Eurocode 5 or an appropriate national code.

The cross section of the connected wooden elements shall have a plane surface against the whole angle bracket.

Zinc-coated angle brackets shall not be fastened with fasteners of stainless steel.

Nails or screws to be used shall have a diameter which fits the holes of the angle brackets.

The structural members to which the brackets are fixed shall be:

- Restrained against rotation.
- Free from wane under the bracket.
- The gap between the timber members does not exceed 3 mm.
- There are no specific requirements relating to preparation of the timber members.

The execution of the connection shall be in accordance with the approval holder's technical literature. For the installation of the angle brackets, the specifications according to EN 1995-1-1, paragraph 10 must be taken into account.

4 Attestation and verification of constancy of performance (AVCP)

4.1 AVCP system

According to the decision 97/638/EC of the European Commission¹, as amended, the system(s) of assessment and verification of constancy of performance (see Annex V to Regulation (EU) No 305/2011) is 2+.

5 Technical details necessary for the implementation of the AVCP system, as foreseen in the applicable EAD

Technical details necessary for the implementation of the AVCP system are laid down in the control plan deposited at ETA-Danmark.

Issued in Copenhagen on 2021-08-17 by

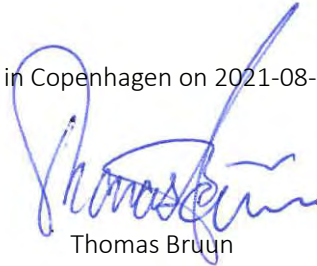

Thomas Bruun

Managing Director, ETA-Danmark

Annex A

Product details and definitions

Table A. 1 Materials specification

Type	Thickness (mm)	Steel specifications*	Coating specification*	Figure	Table
5501S	2,0	S 250 GD	Z 275	A.1	B.2-B.17
5502S	2,0	S 250 GD	Z 275	A.2	B.18-B.B.33
6503S	2,5	S 250 GD	Z 275	A.3	B.34-B.49
6503S13	2,5	S 250 GD	Z 275	A.4	B.50-B.65
6504S	2,5	S 250 GD	Z 275	A.5	B.66-B.81
6504S13	2,5	S 250 GD	Z 275	A.6	B.82-B.97
9003S	3,0	S 250 GD	Z 275	A.7	B.98-B.113
9004S	3,0	S 250 GD	Z 275	A.8	B.114-B.129
5501SA4**	2,0	Stainless steel 1.4571	-	A.1	B.130-B.137
5502SA4**	2,0	Stainless steel 1.4571	-	A.2	B.138-B.145
6503SA4**	2,5	Stainless steel 1.4571	-	A.3	B.146-B.153
6504SA4**	2,5	Stainless steel 1.4571	-	A.5	B.154-B.161
9003SA4**	2,5	Stainless steel 1.4571	-	A.9	B.162-B.169
9004SA4**	2,5	Stainless steel 1.4571	-	A.10	B.170-B.177

Table A. 2 Range of sizes

See details in the following drawings.

Table A. 3 Fastener specification

According to	Type	Diameter (mm)	Finish
EN 14592 or ETA	Profiled nail	4,0	Electroplated zinc
EN 14592 or ETA	Connector screw	5,0	Electroplated zinc
ETA-13/0523	GH ring shanked nail	4,0	Electroplated zinc
ETA-13/0523	GH screw	5,0	Electroplated zinc

(*) According to clause 1 “Technical description of product and intended use” the angle brackets can be made from other steel grades.

(**) Profiled nails of stainless steel according to EN 14592, with the following properties were used:

Diameter: 4,00 mm,
 Length: 40,0 and 60,0 mm,
 Material: Stainless steel 1.4401,
 Characteristic yield moment: $M_{y,k} \geq 6500 \text{ Nmm}$,
 Characteristic withdrawal parameter: $f_{ax,k} \geq 7,50 \text{ N/mm}^2$.

Figure A. 1 Dimensions of Angle Brackets 5501S and 5501SA4

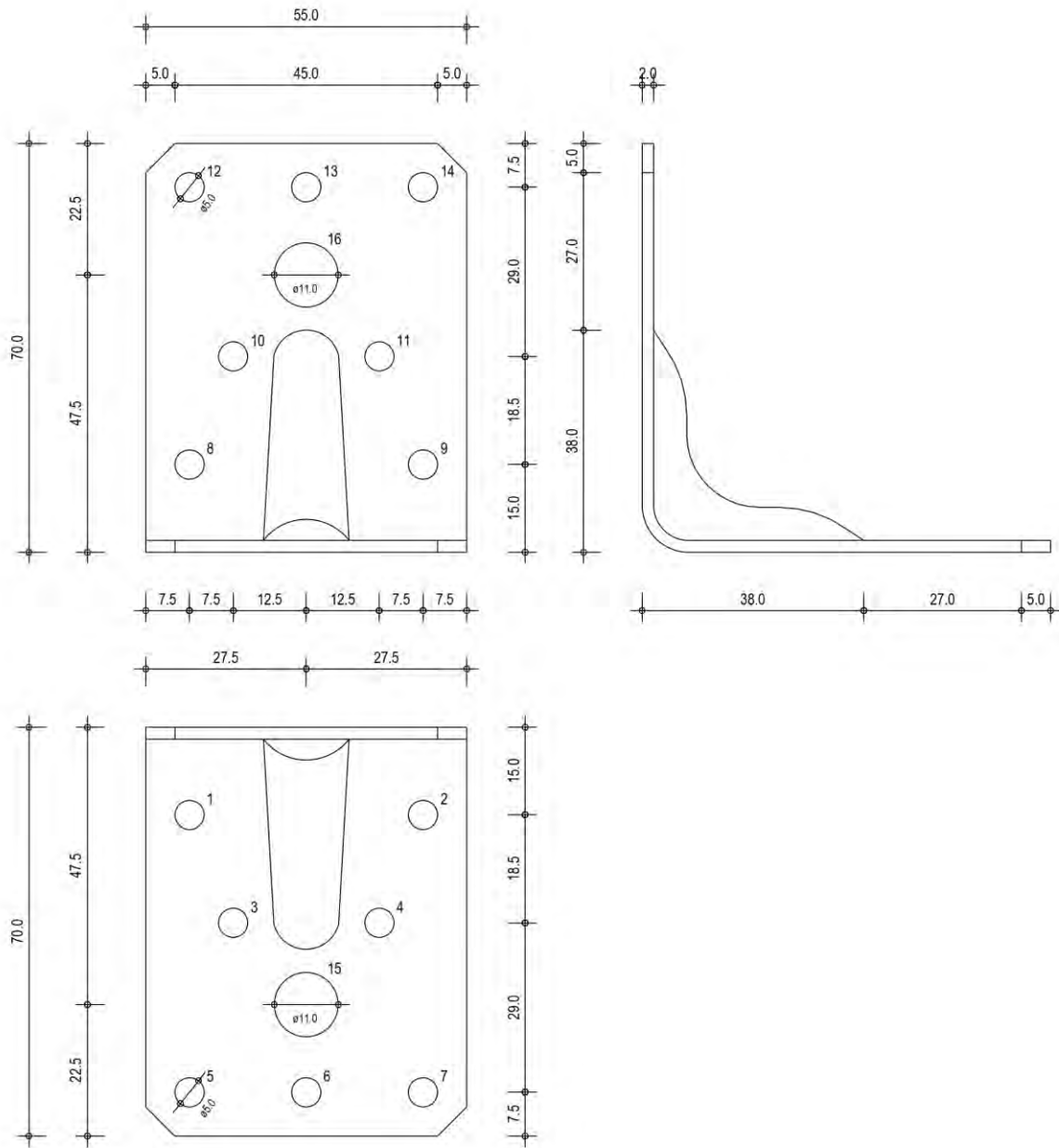

Figure A. 2 Dimensions of Angle Brackets 5502S and 5502SA4

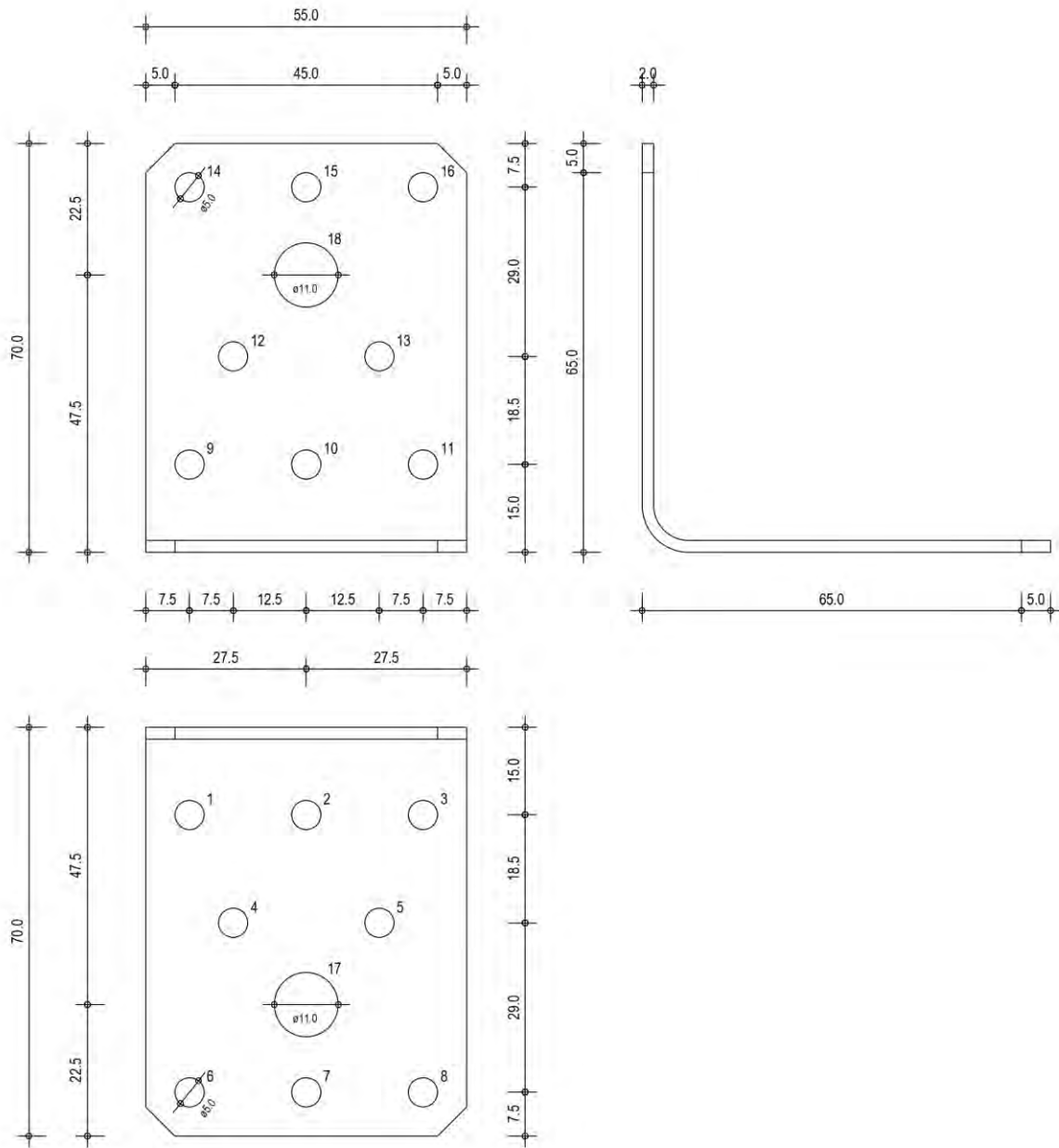

Figure A. 3 Dimensions of Angle Brackets 6503S and 6503SA4

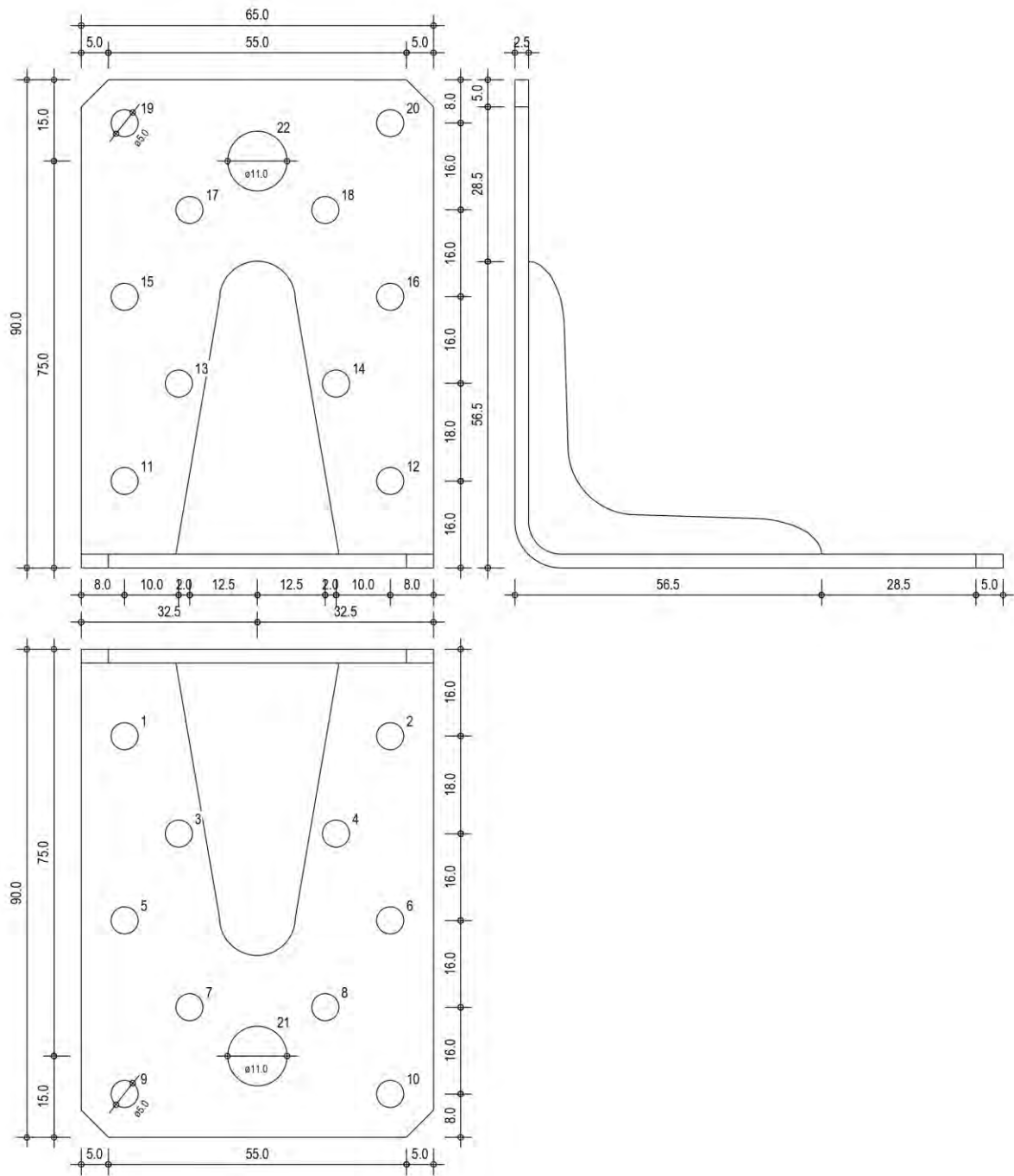

Figure A. 4 Dimensions of Angle Bracket 6503S13

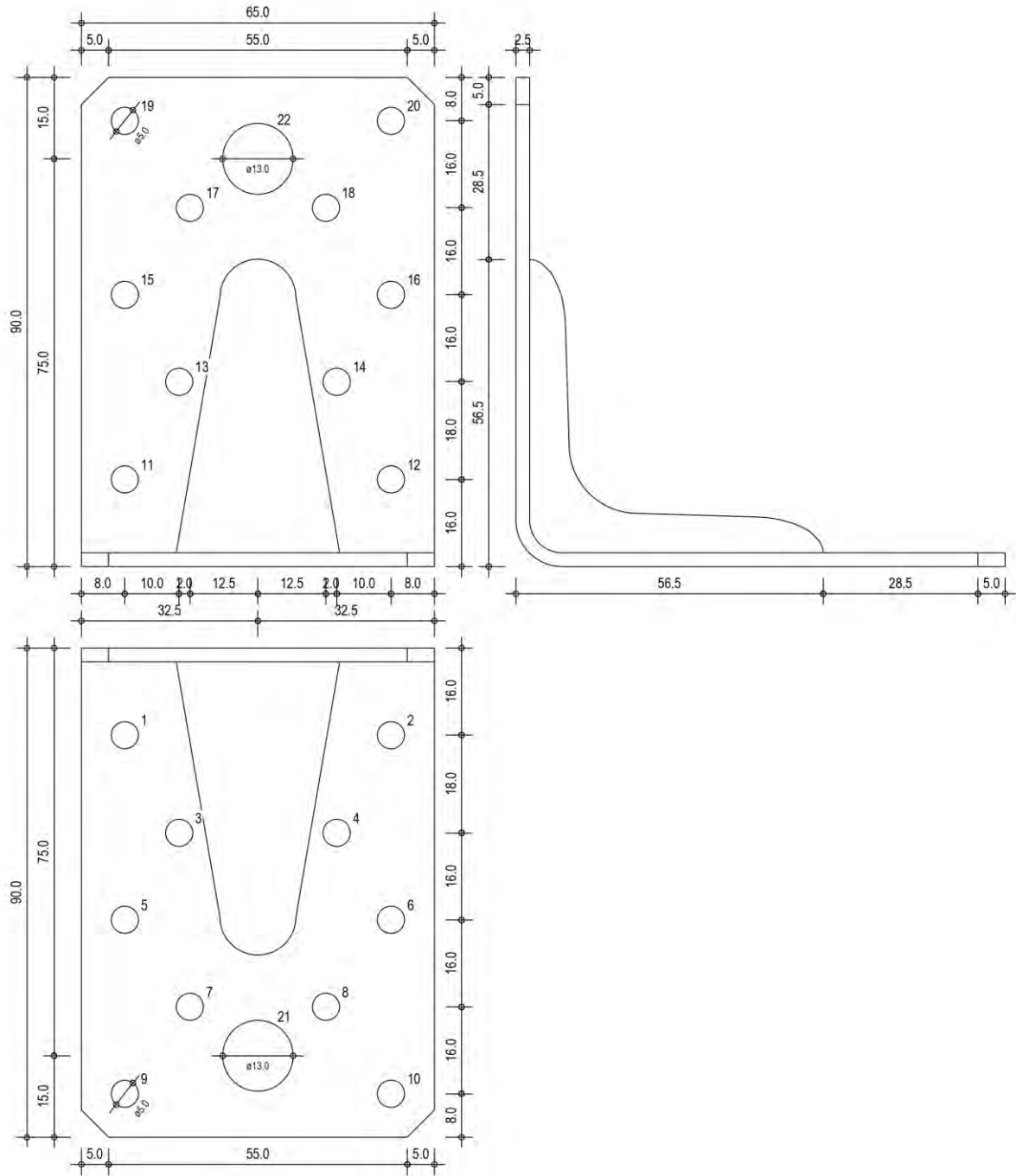

Figure A. 5 Dimensions of Angle Brackets 6504S and 6504SA4

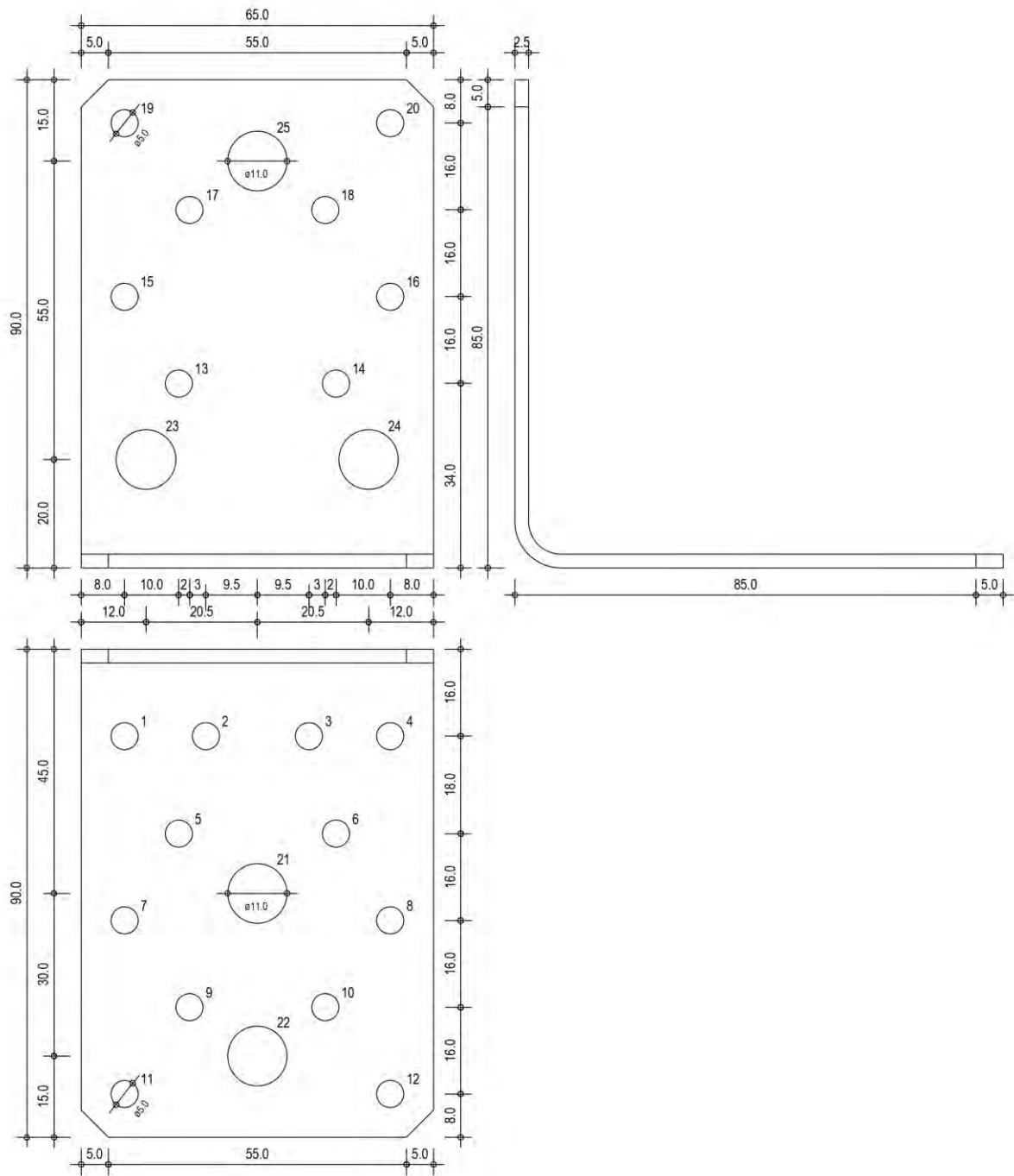

Figure A. 6 Dimensions of Angle Bracket 6504S13

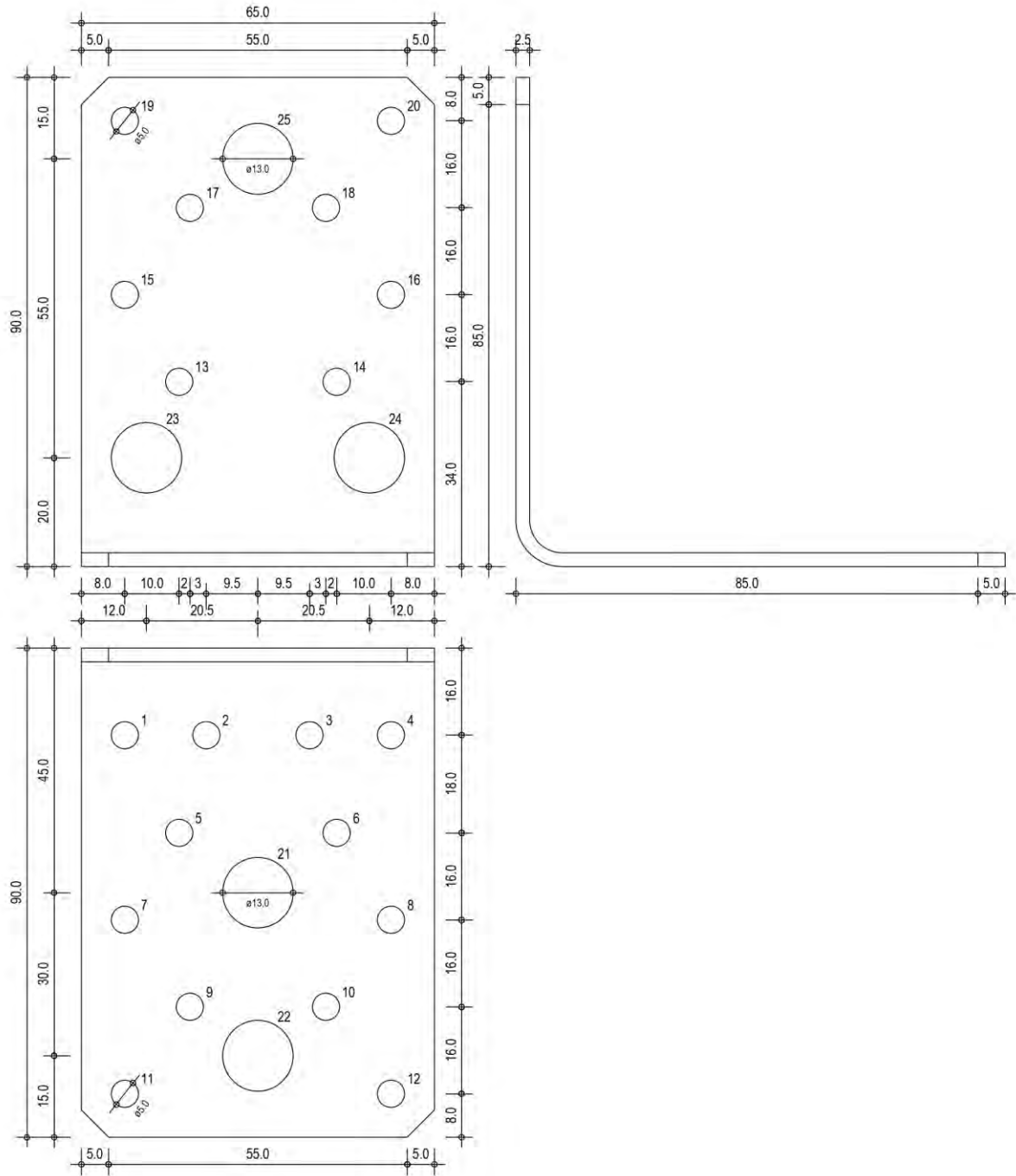

Figure A. 7 Dimensions of Angle Bracket 9003S

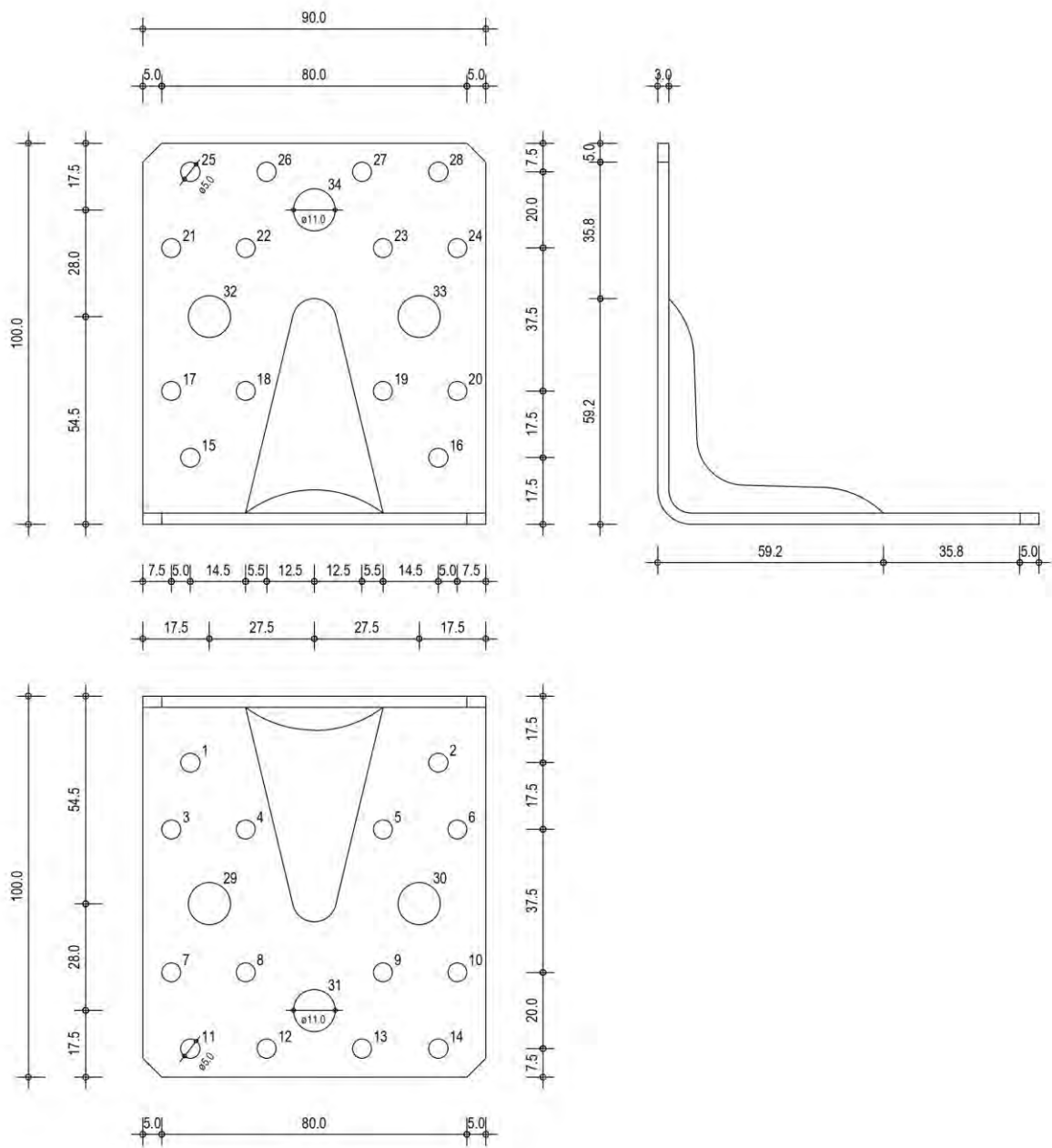

Figure A. 8 Dimensions of Angle Bracket 9004S

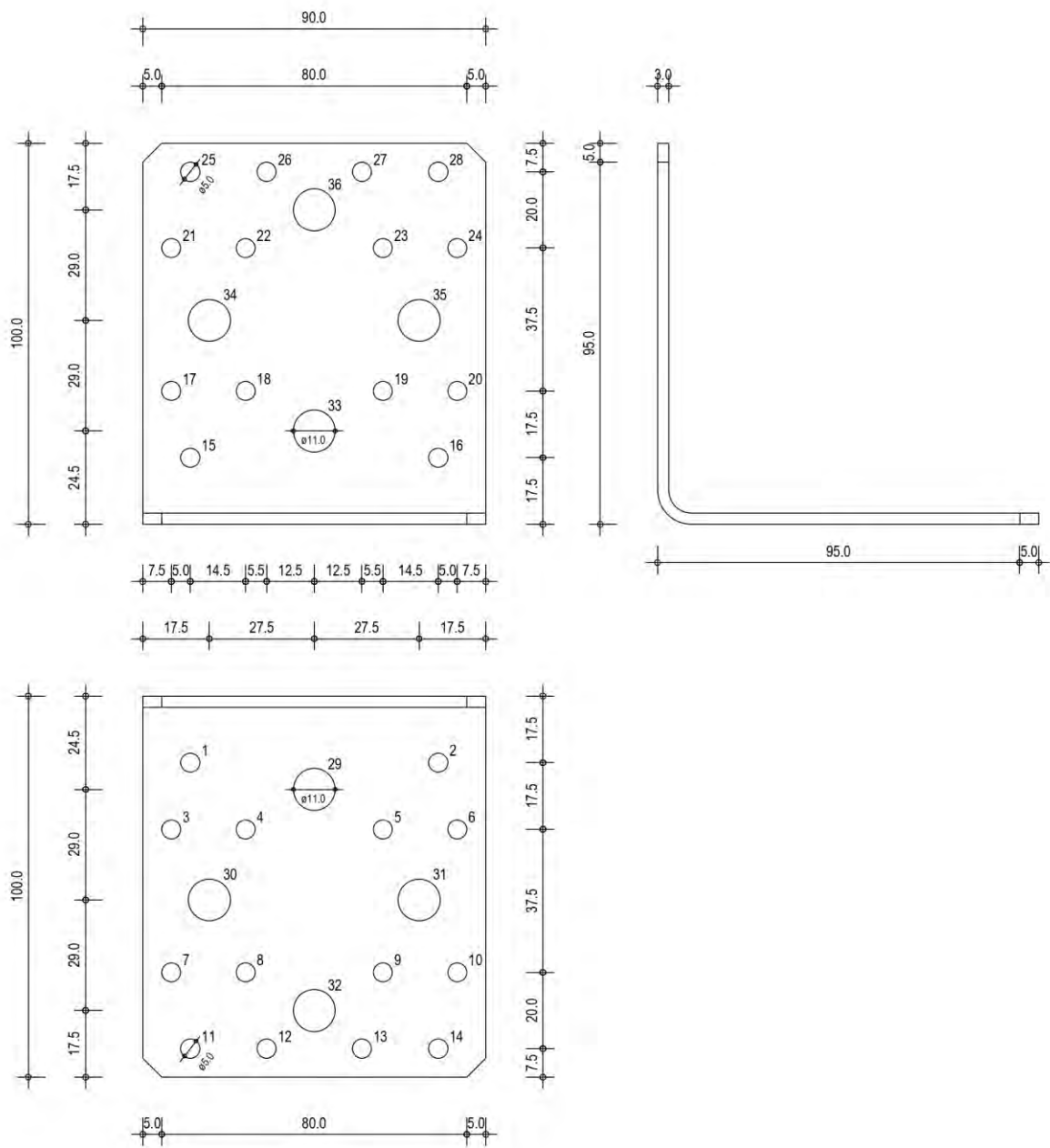

Figure A.9 Dimensions of Angle Bracket 9003SA4

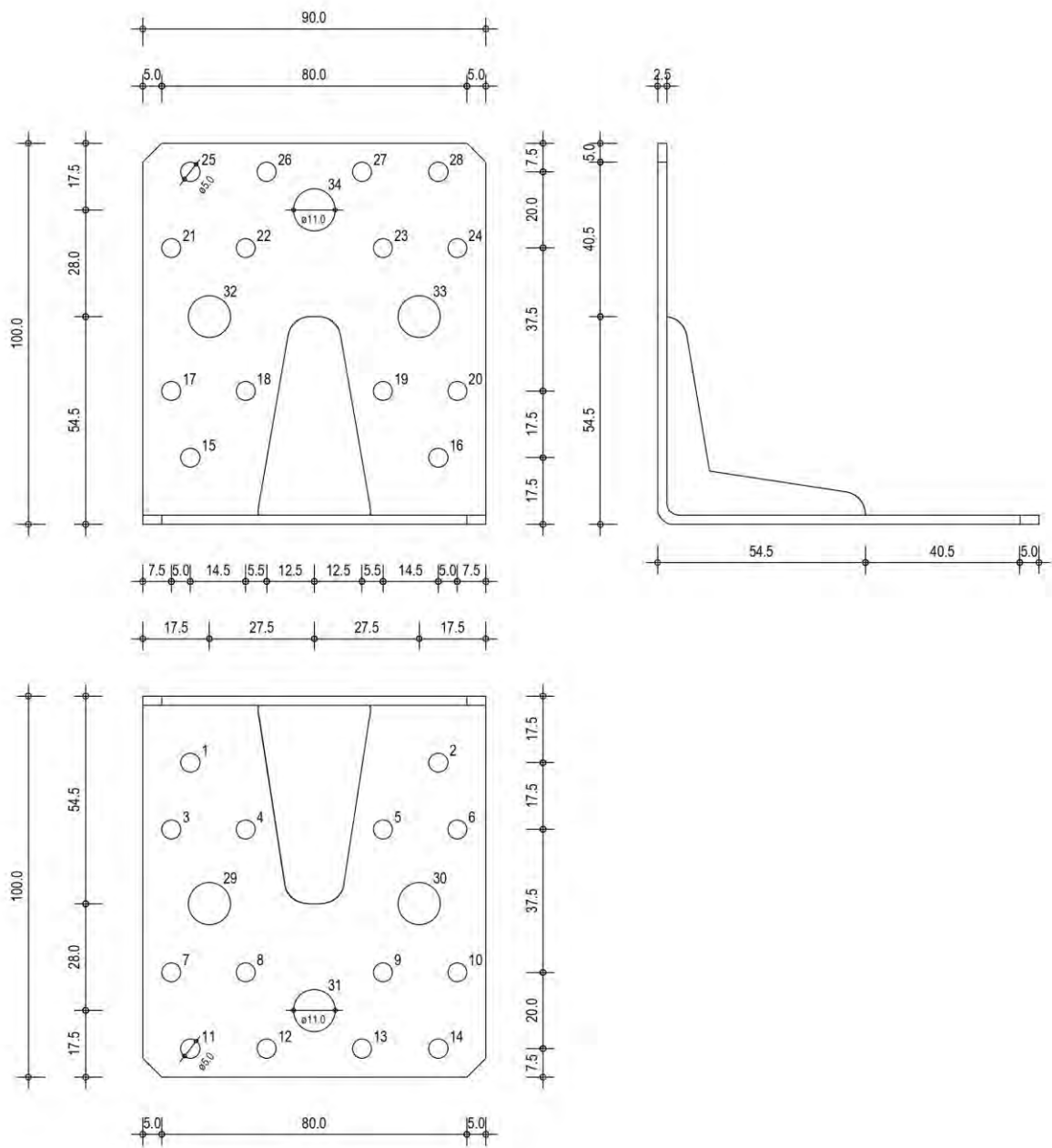
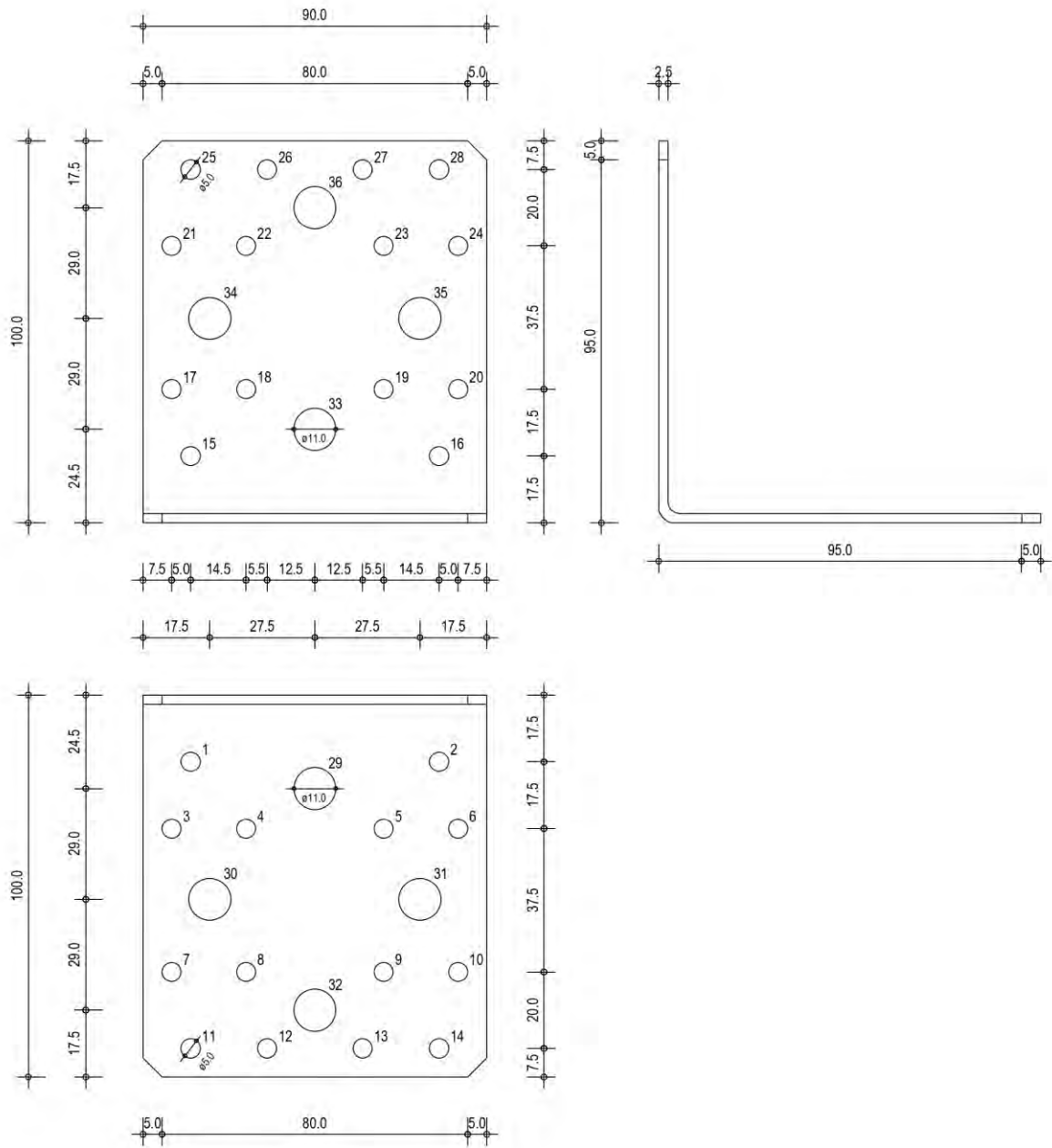

Figure A. 10 Dimensions of Angle Bracket 9004SA4



Annex B

Characteristic load-carrying capacities

Figure B.1 Definitions of forces, their directions and eccentricity forces - Beam to beam connection

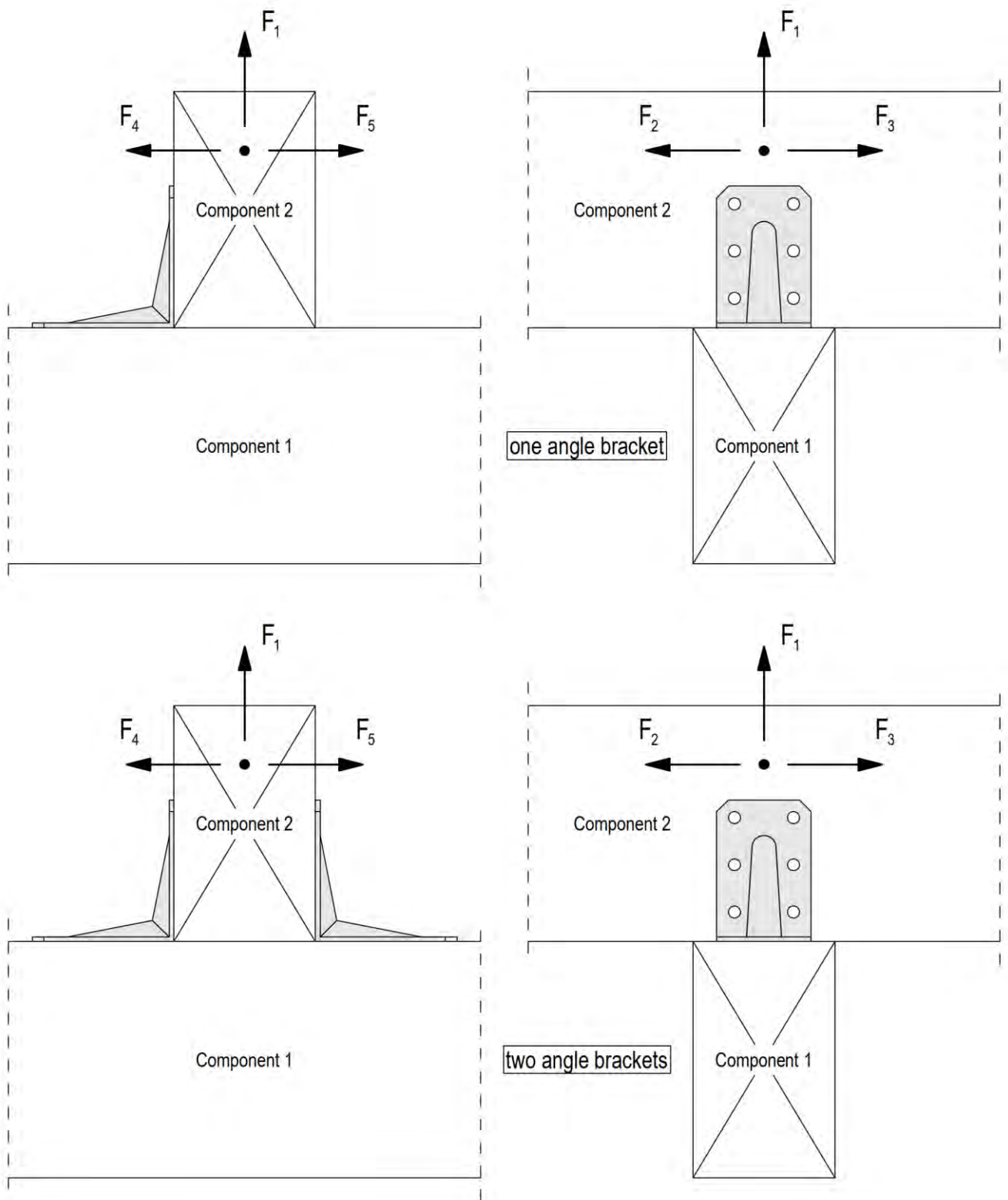
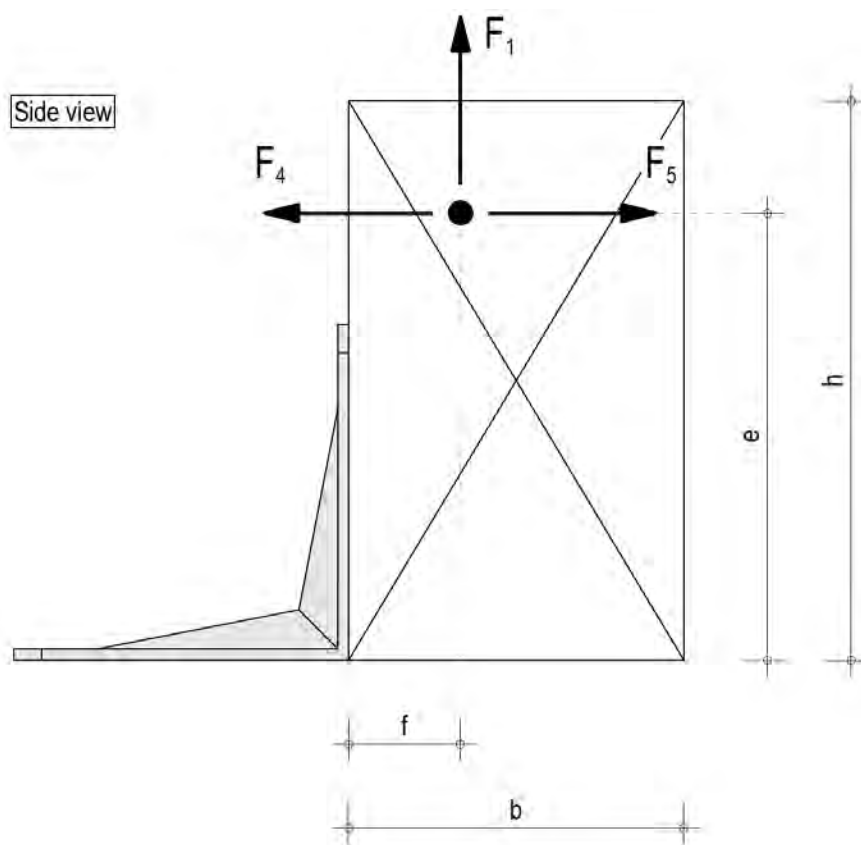

Figure B. 2 Definition of lever arms for forced with eccentricity



Single angle bracket per connection

The component No. 2 shall be prevented from rotation. Acting forces:

- F_1 Lifting force acting in the distance f to the angle bracket.
- F_2 and F_3 Lateral force acting in the joint between the component No. 2 and the component No. 1 in the component No. 2 direction.
- F_4 and F_5 Lateral force acting in the component No. 1 direction in the height of e . F_4 is the lateral force towards the angle bracket; F_5 is the lateral force away from the angle bracket.

Double angle brackets per connection

The angle brackets must be placed at each side opposite each other, symmetric to the component axis. The component 2 shall be prevented from rotation. Acting forces:

- F_1 Lifting force acting along the central axis of the joint.
- F_2 and F_3 Lateral force acting in the joint between the component No. 2 and component No. 1 in the component No. 2 direction.
- F_4 and F_5 Lateral force acting in the component No. 1 direction along the central axis of the joint. If the load is applied with an eccentricity e , a design for combined loading is required. The calculations applied for this ETA already contain the necessary input for eccentric loading.

Permitted load directions

Table B. 1 defines the permitted load directions for every angle bracket.

Proof of load-carrying capacities a single force acting in one direction

$$\eta = F_{i,Ed} / F_{i,Rd} \leq 1,0 \quad (4)$$

Where i is the index of the force direction, respectively of the corresponding load-carrying capacity.

Proof of load-carrying capacities for combined forces

If the forces F_1 or F_2 or F_3 or F_4 or F_5 act at the same time, the following inequality shall be fulfilled:

$$\text{Single angle bracket: } \eta = (F_{1,Ed} / F_{1,Rd})^2 + (F_{2,Ed} / F_{2/3,Rd})^2 + (F_{3,Ed} / F_{2/3,Rd})^2 + (F_{4,Ed} / F_{4,Rd})^2 + (F_{5,Ed} / F_{5,Rd})^2 \leq 1,0 \quad (5)$$

$$\text{Double angle bracket: } \eta = (F_{1,Ed} / F_{1,Rd})^2 + (F_{2,Ed} / F_{2/3,Rd})^2 + (F_{3,Ed} / F_{2/3,Rd})^2 + (F_{4,Ed} / F_{4/5,Rd})^2 + (F_{5,Ed} / F_{4/5,Rd})^2 \leq 1,0 \quad (6)$$

The forces F_2 and F_3 or F_4 and F_5 are forces with opposite direction. Therefore, only one force F_2 or F_3 , respectively, and F_4 or F_5 , respectively, is able to act simultaneously with F_1 , while the other shall be set to zero.

Wane

Wane is not allowed, the timber has to be sharp-edged in the area of the angle brackets.

Timber splitting

For all forces it must be checked in accordance with EN 1995 or a similar national Timber Code that splitting will not occur.

Fastening pattern

Table B. 1 indicates the fastening patterns in the horizontal and vertical leg of the brackets for maximum and partial fastening. The numbers refer to the hole numbers indicated in the drawings in Annex A.

- TTM: Connection of a timber component No. 2 to a timber component No. 1 with a maximum fastening.
- TTP: Connection of a timber component No. 2 to a timber component No. 1 with a partial fastening.
- TCM: Connection of a timber component No. 2 to a concrete or steel component No. 1 with a maximum fastening.
- TCP: Connection of a timber component No. 2 to a concrete or steel component No. 1 with a partial fastening.

Table B. 1 Fastening pattern and permitted load directions

Type	Variant	Horizontal bracket	Vertical bracket	F ₁	F ₂	F ₃	F ₄	F ₅
5501S and 5501SA4	TCM	15	10-11-12-13-14	✓	✓	✓	✓	✓
5501S and 5501SA4	TCP	15	10-11-12-14	✓	✓	✓	✓	✓
5501S and 5501SA4	TTM	1-2-3-4-5-6-7	10-11-12-13-14	✓	✓	✓	✓	✓
5501S and 5501SA4	TTP	1-2-5-7	10-11-12-14	✓	✓	✓	✓	✓
5502S and 5502SA4	TCM	17	12-13-14-15-16	✓	✓	✓	✓	✓
5502S and 5502SA4	TCP	17	12-13	✓	✓	✓	✓	✓
5502S and 5502SA4	TTM	1-2-3-4-5-6-7-8	12-13-14-15-16	✓	✓	✓	✓	✓
5502S and 5502SA4	TTP	1-2-3	12-13	✓	✓	✓	✓	✓
6503S and 6503SA4	TCM	21	13-14-15-16-17-18-19-20	✓	✓	✓	✓	✓
6503S and 6503SA4	TCP	21	13-14-19-20	✓	✓	✓	✓	✓
6503S and 6503SA4	TTM	1-2-3-4-5-6-7-8-9-10	13-14-15-16-17-18-19-20	✓	✓	✓	✓	✓
6503S and 6503SA4	TTP	1-2-3-4-9-10	13-14-19-20	✓	✓	✓	✓	✓
6503S13	TCM	21	13-14-15-16-17-18-19-20	✓	✓	✓	✓	✓
6503S13	TCP	21	13-14-19-20	✓	✓	✓	✓	✓
6503S13	TTM	1-2-3-4-5-6-7-8-9-10	13-14-15-16-17-18-19-20	✓	✓	✓	✓	✓
6503S13	TTP	1-2-3-4-9-10	13-14-19-20	✓	✓	✓	✓	✓
6504S and 6504SA4	TCM	21	13-14-15-16-17-18-19-20	✓	✓	✓	✓	✓
6504S and 6504SA4	TCP	21	13-14-19-20	✓	✓	✓	✓	✓
6504S and 6504SA4	TTM	1-2-3-4-5-6-7-8-9-10-11-12	13-14-15-16-17-18-19-20	✓	✓	✓	✓	✓
6504S and 6504SA4	TTP	1-2-3-4-11-12	13-14-19-20	✓	✓	✓	✓	✓
6504S13	TCM	21	13-14-15-16-17-18-19-20	✓	✓	✓	✓	✓
6504S13	TCP	21	13-14-19-20	✓	✓	✓	✓	✓
6504S13	TTM	1-2-3-4-5-6-7-8-9-10-11-12	13-14-15-16-17-18-19-20	✓	✓	✓	✓	✓
6504S13	TTP	1-2-3-4-11-12	13-14-19-20	✓	✓	✓	✓	✓
9003S	TCM	29-30	17-18-19-20-21-22-23-24-25-26-27	✓	✓	✓	✓	✓
9003S	TCP	29-30	17-18-19-20-25-26-27-28	✓	✓	✓	✓	✓
9003S	TTM	1-2-3-4-5-6-7-8-9-10-11-12-13-14	17-18-19-20-21-22-23-24-25-26-27	✓	✓	✓	✓	✓
9003S	TTP	1-2-3-6-11-14	17-18-19-20-25-26-27-28	✓	✓	✓	✓	✓
9004S	TCM	29-32	17-18-19-20-21-22-23-24-25-26-27	✓	✓	✓	✓	✓
9004S	TCP	29-32	17-18-19-20-25-26-27-28	✓	✓	✓	✓	✓
9004S	TTM	1-2-3-4-5-6-7-8-9-10-11-12-13-14	17-18-19-20-21-22-23-24-25-26-27	✓	✓	✓	✓	✓
9004S	TTP	1-2-3-6-11-14	17-18-19-20-25-26-27-28	✓	✓	✓	✓	✓
9003SA4	TCM	29-30	17-18-19-20-21-22-23-24-25-26-27	✓	✓	✓	✓	✓
9003SA4	TCP	29-30	17-18-19-20-25-26-27-28	✓	✓	✓	✓	✓
9003SA4	TTM	1-2-3-4-5-6-7-8-9-10-11-12-13-14	17-18-19-20-21-22-23-24-25-26-27	✓	✓	✓	✓	✓
9003SA4	TTP	1-2-3-6-11-14	17-18-19-20-25-26-27-28	✓	✓	✓	✓	✓
9004SA4	TCM	29-32	17-18-19-20-21-22-23-24-25-26-27	✓	✓	✓	✓	✓
9004SA4	TCP	29-32	17-18-19-20-25-26-27-28	✓	✓	✓	✓	✓
9004SA4	TTM	1-2-3-4-5-6-7-8-9-10-11-12-13-14	17-18-19-20-21-22-23-24-25-26-27	✓	✓	✓	✓	✓
9004SA4	TTP	1-2-3-6-11-14	17-18-19-20-25-26-27-28	✓	✓	✓	✓	✓

The characteristic capacities for connection with the angle brackets 5501S, 5502S, 6503S, 6503S13, 6504S, 6504S13, 9003S and 9004S, given in the following tables, are based on calculations presuming brackets made from pre-galvanized steel S 250 GD + Z275 with a minimum yield stress of 235 MPa. The characteristic capacities for connection with the angle brackets 5501SA4, 5502SA4, 6503SA4, 6504SA4, 9003SA4 and 9004SA4, given in the following tables, are based on calculations presuming brackets made from stainless steel 1.4571 with a minimum yield stress of 220 MPa. According to clause 1 "Technical description of product and intended use" the angle brackets can be made from other steel grades.

Interlayer

The characteristic capacities for connection with the angle brackets given in the following tables also apply in the case of an interlayer between the vertical leg of the angle bracket and the timber component. The following conditions must be observed:

- The interlayer must be immovable.
- The embedding depth of the profiled area of the nail or the thread length of the screw in the timber component 2 must be equal or higher. A correspondingly longer fastener must be used for this purpose.
- The characteristic embedding strength $f_{h,k}$ of the fastener in the interlayer must be equal or higher.

Connection to steel or concrete elements with bolts or metal anchors

The load $F_{B,Ed}$ for the design of one bolt or one metal anchor is calculated as:

$$F_{B,Ed} = k_t \cdot F_{i,Ed} \quad (7)$$

where

$F_{B,Ed}$ axial load on one bolt or one metal anchor,

k_t coefficient taking into account the lever arm,

$F_{i,Ed}$ load acting on the angle connector in the direction of index i .

Load-capacity values

The Figure B. 2 describes the geometric factors used in the following load-carrying capacity tables.

Table B. 2 Angle bracket type 5501S, Variant TCM, Fastener GH Nail 4x40, Density 350 kg/m³

Characteristic load-carrying capacity F_{1,Rk} (N) for one / two angle brackets

angle bracket		1													2
f (mm)		0	10	20	30	40	50	60	70	80	90	100	110	120	0
F _{1,Rk}	T	9450	810	405	270	203	162	135	116	101	89	80	73	67	18900
	S	250	210	181	160	142	128	117	107	99	93	87	81	77	500
k _t (-)		9,6	11,5	13,3	15,1	16,9	18,7	20,5	22,4	24,2	26,0	27,8	29,6	31,5	4,8

Characteristic load-carrying capacity F_{2/3,Rk} (N) for one / two angle brackets

angle bracket		1	2
F _{2/3,Rk}	T	1300	2600
	S	-	-

Characteristic load-carrying capacity F_{4,Rk} (N) for one angle bracket

e (mm)		0	20	40	60	80	100	120	140	160	180	200	220	240	260	280	300	320
F _{4,Rk}	T	-	-	4050	368	193	130	98	79	66	57	49	44	40	36	33	30	28
	S	-	664	332	221	166	133	111	95	83	74	66	60	55	51	47	44	42
k _t (-)		0,0	3,6	7,3	10,9	14,5	18,2	21,8	25,5	29,1	32,7	36,4	40,0	43,6	47,3	50,9	54,5	58,2

Characteristic load-carrying capacity F_{5,Rk} (N) for one angle bracket

b / e (mm)		0	20	40	60	80	100	120	140	160	180	200	220	240	260	280	300	320
0	T	213	449	1507	1004	753	602	502	430	376	334	301	274	251	231	215	200	188
	S	405	856	2868	1912	1434	1147	956	819	717	637	574	521	478	441	410	382	358
20	T	213	449	1436	957	718	574	478	410	359	319	287	261	239	220	205	191	179
	S	405	856	2868	1912	1434	1147	956	819	717	637	574	521	478	441	410	382	358
40	T	213	449	1488	992	744	595	496	425	372	330	297	270	248	229	212	198	186
	S	405	856	2868	1912	1434	1147	956	819	717	637	574	521	478	441	410	382	358
60	T	213	449	1499	999	749	599	499	428	374	333	299	272	249	230	214	199	187
	S	405	856	2868	1912	1434	1147	956	819	717	637	574	521	478	441	410	382	358
80	T	213	449	1502	1001	751	601	500	429	375	333	300	273	250	231	214	200	187
	S	405	856	2868	1912	1434	1147	956	819	717	637	574	521	478	441	410	382	358
100	T	213	449	1504	1002	752	601	501	429	376	334	300	273	250	231	214	200	188
	S	405	856	2868	1912	1434	1147	956	819	717	637	574	521	478	441	410	382	358
120	T	213	449	1505	1003	752	602	501	430	376	334	301	273	250	231	215	200	188
	S	405	856	2868	1912	1434	1147	956	819	717	637	574	521	478	441	410	382	358
140	T	213	449	1505	1003	752	602	501	430	376	334	301	273	250	231	215	200	188
	S	405	856	2868	1912	1434	1147	956	819	717	637	574	521	478	441	410	382	358
160	T	213	449	1506	1004	753	602	502	430	376	334	301	273	251	231	215	200	188
	S	405	856	2868	1912	1434	1147	956	819	717	637	574	521	478	441	410	382	358
180	T	213	449	1506	1004	753	602	502	430	376	334	301	273	251	231	215	200	188
	S	405	856	2868	1912	1434	1147	956	819	717	637	574	521	478	441	410	382	358
200	T	213	449	1506	1004	753	602	502	430	376	334	301	273	251	231	215	200	188
	S	405	856	2868	1912	1434	1147	956	819	717	637	574	521	478	441	410	382	358
220	T	213	449	1506	1004	753	602	502	430	376	334	301	273	251	231	215	200	188
	S	405	856	2868	1912	1434	1147	956	819	717	637	574	521	478	441	410	382	358
240	T	213	449	1506	1004	753	602	502	430	376	334	301	273	251	231	215	200	188
	S	405	856	2868	1912	1434	1147	956	819	717	637	574	521	478	441	410	382	358
k _t x b (-)		0,0	16,7	33,4	50,1	66,8	83,5	100,2	116,9	133,6	150,3	167,0	183,7	200,3	217,0	233,7	250,4	267,1

Characteristic load-carrying capacity F_{4/5,Rk} (N) for two angle brackets

b / e (mm)		0	20	40	60	80	100	120	140	160	180	200	220	240	260	280	300	320
0	T	8999	8999	8999	8999	8999	8999	8999	8999	8999	8999	8999	8999	8999	8999	8999	8999	8999
	S	-	-	-	-	-	-	-	-	-	-	-	-	-	-	-	-	-
20	T	8999	9000	4725	3150	2363	1890	1575	1350	1181	1050	945	859	788	727	675	630	591
	S	-	250	125	83	62	50	41	35	31	27	25	22	20	19	17	16	15
40	T	8999	9000	9000	6300	4725	3780	3150	2700	2363	2100	1890	1718	1575	1454	1350	1260	1181
	S	-	501	250	167	125	100	83	71	62	55	50	45	41	38	35	33	31
60	T	8999	9000	9000	9000	7088	5670	4725	4050	3544	3150	2835	2577	2363	2181	2025	1890	1772
	S	-	751	375	250	187	150	125	107	93	83	75	68	62	57	53	50	46
80	T	8999	9000	9000	9000	9000	7560	6300	5400	4725	4200	3780	3436	3150	2908	2700	2520	2363
	S	-	1002	501	334	250	200	167	143	125	111	100	91	83	77	71	66	62
100	T	8999	9000	9000	9000	9000	7875	6750	5906	5250	4725	4295	3938	3635	3375	3150	2953	2793
	S	-	1253	626	417	313	250	208	179	156	139	125	113	104	96	89	83	78
120	T	8999	9000	9000	9000	9000	9000	9000	8100	7088	6300	5670	5155	4725	4362	4050	3780	3544
	S	-	1503	751	501	375	300	250	214	187	167	150	136	125	115	107	100	93
140	T	8999	9000	9000	9000	9000	9000	9000	8269	7350	6615	6014	5513	5088	4725	4410	4134	3883
	S	-	1754	877	584	438	350	292	250	219	194	175	159	146	134	125	116	109
160	T	8999	9000	9000	9000	9000	9000	9000	9000	8400	7560	6873	6300	5815	5400	5040	4725	4453
	S	-	2004	1002	668	501	400	334	286	250	222	200	182	167	154	143	133	125
180	T	8999	9000	9000	9000	9000	9000	9000	9000	9000	9000	8505	7732	7088	6542	6075	5670	5316
	S	-	2255	1127	751	563	451	375	322	281	250	225	205	187	173	161	150	140
200	T	8999	9000	9000	9000	9000	9000	9000	9000	9000	9000	9000	8591	7875	7269	6750	6300	5906
	S	-	2506	1253	835	626	501	417	358	313	278	250	227	208	192	179	167	156
220	T	8999	9000	9000	9000	9000	9000	9000	9000	9000	9000	9000	9000	8663	7996	7425	6930	6497
	S	-	2756	1378	918	689	551	459	393	344	306	275	250	229	212	196	183	172
240	T	8999	9000	9000	9000	9000	9000	9000	9000	9000	9000	9000	9000	9000	8723	8100	7560	7088
	S	-	3007	1503	1002	751	601	501	429	375	334	300	273	250	231	214	200	187
k _t x b (-)		0,0	192,7	385,5	578,2	770,9	963,6	1156,4	1349,1	1541,8	1734,5	1927,3	2120,0	2312,7	2505,5	2698,2	2890,9	3083,6

TTM: Timber-Timber-Maximum | TTP: Timber-Timber-Partial | TCM: Timber-Concrete-Maximum | TCP: Timber-Concrete-Partial

T: F_{1,T,Rk} load-carrying capacity of timber | S: F_{1,S,Rk} load-carrying capacity of steel

Table B.3 Angle bracket type 5501S, Variant TCM, Fastener GH Nail 4x60, Density 350 kg/m³Characteristic load-carrying capacity $F_{1,Rk}$ (N) for one / two angle brackets

angle bracket		1													2
f (mm)		0	10	20	30	40	50	60	70	80	90	100	110	120	0
$F_{1,Rk}$	T	11820	1350	675	450	338	270	225	193	169	150	135	123	113	23640
	S	250	210	181	160	142	128	117	107	99	92	86	81	76	
k_t (-)		9,6	11,5	13,3	15,1	16,9	18,7	20,5	22,4	24,2	26,0	27,8	29,6	31,5	4,8

Characteristic load-carrying capacity $F_{2/3,Rk}$ (N) for one / two angle brackets

angle bracket		1	2
$F_{2/3,Rk}$	T	2000	4000
	S	-	-

Characteristic load-carrying capacity $F_{4,Rk}$ (N) for one angle bracket

e (mm)		0	20	40	60	80	100	120	140	160	180	200	220	240	260	280	300	320
$F_{4,Rk}$	T	-	-	6750	614	321	218	165	132	111	95	83	74	67	61	56	52	48
	S	-	664	332	221	166	132	110	94	83	73	66	60	55	51	47	44	41
k_t (-)		0,0	3,6	7,3	10,9	14,5	18,2	21,8	25,5	29,1	32,7	36,4	40,0	43,6	47,3	50,9	54,5	58,2

Characteristic load-carrying capacity $F_{5,Rk}$ (N) for one angle bracket

b / e (mm)		0	20	40	60	80	100	120	140	160	180	200	220	240	260	280	300	320
0	T	355	749	2512	1675	1256	1005	837	717	628	558	502	456	418	386	358	334	314
	S	405	856	2868	1912	1434	1147	956	819	717	637	574	521	478	441	410	382	358
20	T	355	749	2312	1541	1156	924	770	660	578	513	462	420	385	355	330	308	289
	S	405	856	2868	1912	1434	1147	956	819	717	637	574	521	478	441	410	382	358
40	T	355	749	2457	1638	1228	983	819	702	614	546	491	446	409	378	351	327	307
	S	405	856	2868	1912	1434	1147	956	819	717	637	574	521	478	441	410	382	358
60	T	355	749	2487	1658	1243	995	829	710	621	552	497	452	414	382	355	331	310
	S	405	856	2868	1912	1434	1147	956	819	717	637	574	521	478	441	410	382	358
80	T	355	749	2498	1665	1249	999	832	713	624	555	499	454	416	384	356	333	312
	S	405	856	2868	1912	1434	1147	956	819	717	637	574	521	478	441	410	382	358
100	T	355	749	2503	1668	1251	1001	834	715	625	556	500	455	417	385	357	333	312
	S	405	856	2868	1912	1434	1147	956	819	717	637	574	521	478	441	410	382	358
120	T	355	749	2506	1670	1253	1002	835	716	626	556	501	455	417	385	358	334	313
	S	405	856	2868	1912	1434	1147	956	819	717	637	574	521	478	441	410	382	358
140	T	355	749	2507	1671	1253	1003	835	716	626	557	501	455	417	385	358	334	313
	S	405	856	2868	1912	1434	1147	956	819	717	637	574	521	478	441	410	382	358
160	T	355	749	2508	1672	1254	1003	836	716	627	557	501	456	418	385	358	334	313
	S	405	856	2868	1912	1434	1147	956	819	717	637	574	521	478	441	410	382	358
180	T	355	749	2509	1673	1254	1003	836	717	627	557	501	456	418	386	358	334	313
	S	405	856	2868	1912	1434	1147	956	819	717	637	574	521	478	441	410	382	358
200	T	355	749	2510	1673	1255	1004	836	717	627	557	502	456	418	386	358	334	313
	S	405	856	2868	1912	1434	1147	956	819	717	637	574	521	478	441	410	382	358
220	T	355	749	2510	1673	1255	1004	836	717	627	557	502	456	418	386	358	334	313
	S	405	856	2868	1912	1434	1147	956	819	717	637	574	521	478	441	410	382	358
240	T	355	749	2510	1673	1255	1004	836	717	627	557	502	456	418	386	358	334	313
	S	405	856	2868	1912	1434	1147	956	819	717	637	574	521	478	441	410	382	358
$k_t \times b$ (-)		0,0	16,7	33,4	50,1	66,8	83,5	100,2	116,9	133,6	150,3	167,0	183,7	200,3	217,0	233,7	250,4	267,1

Characteristic load-carrying capacity $F_{4/5,Rk}$ (N) for two angle brackets

b / e (mm)		0	20	40	60	80	100	120	140	160	180	200	220	240	260	280	300	320
0	T	15000	15000	15000	15000	15000	15000	15000	15000	15000	15000	15000	15000	15000	15000	15000	15000	15000
	S	-	-	-	-	-	-	-	-	-	-	-	-	-	-	-	-	-
20	T	15000	11820	5910	3940	2955	2364	1970	1689	1478	1313	1182	1075	985	909	844	788	739
	S	-	250	125	83	62	50	41	35	31	27	25	22	20	19	17	16	15
40	T	15000	15000	11820	7880	5910	4728	3940	3377	2955	2627	2364	2149	1970	1818	1689	1576	1478
	S	-	501	250	167	125	100	83	71	62	55	50	45	41	38	35	33	31
60	T	15000	15000	15000	11820	8865	7092	5910	5066	4433	3940	3546	3224	2955	2728	2533	2364	2216
	S	-	751	375	250	187	150	125	107	93	83	75	68	62	57	53	50	46
80	T	15000	15000	15000	15000	11820	9456	7880	6754	5910	5253	4728	4298	3940	3637	3377	3152	2955
	S	-	1002	501	334	250	200	167	143	125	111	100	91	83	77	71	66	62
100	T	15000	15000	15000	15000	14775	11820	9850	8443	7388	6567	5910	5373	4925	4546	4221	3940	3694
	S	-	1253	626	417	313	250	208	179	156	139	125	113	104	96	89	83	78
120	T	15000	15000	15000	15000	15000	14184	11820	10131	8865	7880	7092	6447	5910	5455	5066	4728	4433
	S	-	1503	751	501	375	300	250	214	187	167	150	136	125	115	107	100	93
140	T	15000	15000	15000	15000	15000	13790	11820	10343	9193	8274	7522	6895	6365	5910	5516	5171	4868
	S	-	1754	877	584	438	350	292	250	219	194	175	159	146	134	125	116	109
160	T	15000	15000	15000	15000	15000	15000	13509	11820	10507	9456	8596	7880	7274	6754	6304	5910	5510
	S	-	2004	1002	668	501	400	334	286	250	222	200	182	167	154	143	133	125
180	T	15000	15000	15000	15000	15000	15000	15000	13298	11820	10638	9671	8865	8183	7599	7092	6649	6249
	S	-	2255	1127	751	563	451	375	322	281	250	225	205	187	173	161	150	140
200	T	15000	15000	15000	15000	15000	15000	15000	14775	13133	11820	10745	9850	9092	8443	7880	7388	6938
	S	-	2506	1253	835	626	501	417	358	313	278	250	227	208	192	179	167	156
220	T	15000	15000	15000	15000	15000	15000	15000	15000	14447	13002	11820	10835	10002	9287	8668	8126	7688
	S	-	2756	1378	918	689	551	459	393	344	306	275	250	229	212	196	183	172
240	T	15000	15000	15000	15000	15000	15000	15000	15000	15000	14184	12895	11820	10911	10131	9456	8865	8365
	S	-	3007	1503	1002	751	601	501	429	375	334	300	273	250	231	214	200	187
$k_t \times b$ (-)		0,0	192,7	385,5	578,2	770,9	963,6	1156,4	1349,1	1541,8	1734,5	1927,3	2120,0	2312,7	2505,5	2698,2	2890,9	3083,6

TTM: Timber-Timber-Maximum | TTP: Timber-Timber-Partial | TCM: Timber-Concrete-Maximum | TCP: Timber-Concrete-Partial

T: $F_{1,T,Rk}$ load-carrying capacity of timber | S: $F_{1,S,Rk}$ load-carrying capacity of steel

Table B.4 Angle bracket type 5501S, Variant TCM, Fastener GH Screw 5x40, Density 350 kg/m³Characteristic load-carrying capacity $F_{1,Rk}$ (N) for one / two angle brackets

angle bracket		1													2
f (mm)		0	10	20	30	40	50	60	70	80	90	100	110	120	0
$F_{1,Rk}$	T	10015	1701	850	567	425	340	284	243	213	189	170	155	142	20030
	S	250	210	181	160	142	128	117	107	99	92	86	81	76	500
$k_t (-)$		9,6	11,5	13,3	15,1	16,9	18,7	20,5	22,4	24,2	26,0	27,8	29,6	31,5	4,8

Characteristic load-carrying capacity $F_{2/3,Rk}$ (N) for one / two angle brackets

angle bracket		1	2
$F_{2/3,Rk}$	T	2130	4260
	S	-	-

Characteristic load-carrying capacity $F_{4,Rk}$ (N) for one angle bracket

e (mm)		0	20	40	60	80	100	120	140	160	180	200	220	240	260	280	300	320
$F_{4,Rk}$	T	-	-	8505	773	405	274	207	167	139	120	105	93	84	77	70	65	60
	S	-	664	332	221	166	132	110	94	83	73	66	60	55	51	47	44	41
$k_t (-)$		0,0	3,6	7,3	10,9	14,5	18,2	21,8	25,5	29,1	32,7	36,4	40,0	43,6	47,3	50,9	54,5	58,2

Characteristic load-carrying capacity $F_{5,Rk}$ (N) for one angle bracket

b / e (mm)		0	20	40	60	80	100	120	140	160	180	200	220	240	260	280	300	320
0	T	448	945	3166	2111	1583	1266	1055	905	791	704	633	576	528	487	452	422	396
	S	405	856	2867	1911	1433	1147	955	819	716	637	573	521	477	441	409	382	358
20	T	448	945	2675	1783	1337	1070	891	764	668	594	535	486	445	411	382	356	334
	S	405	856	2868	1912	1434	1147	956	819	717	637	574	521	478	441	410	382	358
40	T	448	945	3166	2111	1583	1266	1055	905	791	704	633	576	528	487	452	422	396
	S	405	856	2867	1911	1433	1147	955	819	716	637	573	521	477	441	409	382	358
60	T	448	945	3166	2111	1583	1266	1055	905	791	704	633	576	528	487	452	422	396
	S	405	856	2867	1911	1433	1147	955	819	716	637	573	521	477	441	409	382	358
80	T	448	945	3166	2111	1583	1266	1055	905	791	704	633	576	528	487	452	422	396
	S	405	856	2867	1911	1433	1147	955	819	716	637	573	521	477	441	409	382	358
100	T	448	945	3166	2111	1583	1266	1055	905	791	704	633	576	528	487	452	422	396
	S	405	856	2867	1911	1433	1147	955	819	716	637	573	521	477	441	409	382	358
120	T	448	945	3166	2111	1583	1266	1055	905	791	704	633	576	528	487	452	422	396
	S	405	856	2867	1911	1433	1147	955	819	716	637	573	521	477	441	409	382	358
140	T	448	945	3166	2111	1583	1266	1055	905	791	704	633	576	528	487	452	422	396
	S	405	856	2867	1911	1433	1147	955	819	716	637	573	521	477	441	409	382	358
160	T	448	945	3166	2111	1583	1266	1055	905	791	704	633	576	528	487	452	422	396
	S	405	856	2867	1911	1433	1147	955	819	716	637	573	521	477	441	409	382	358
180	T	448	945	3166	2111	1583	1266	1055	905	791	704	633	576	528	487	452	422	396
	S	405	856	2867	1911	1433	1147	955	819	716	637	573	521	477	441	409	382	358
200	T	448	945	3166	2111	1583	1266	1055	905	791	704	633	576	528	487	452	422	396
	S	405	856	2867	1911	1433	1147	955	819	716	637	573	521	477	441	409	382	358
220	T	448	945	3166	2111	1583	1266	1055	905	791	704	633	576	528	487	452	422	396
	S	405	856	2867	1911	1433	1147	955	819	716	637	573	521	477	441	409	382	358
240	T	448	945	3166	2111	1583	1266	1055	905	791	704	633	576	528	487	452	422	396
	S	405	856	2867	1911	1433	1147	955	819	716	637	573	521	477	441	409	382	358
$k_t \times b (-)$		0,0	16,7	33,4	50,1	66,8	83,5	100,2	116,9	133,6	150,3	167,0	183,7	200,3	217,0	233,7	250,4	267,1

Characteristic load-carrying capacity $F_{4/5,Rk}$ (N) for two angle brackets

b / e (mm)		0	20	40	60	80	100	120	140	160	180	200	220	240	260	280	300	320
0	T	18899	18899	18899	18899	18899	18899	18899	18899	18899	18899	18899	18899	18899	18899	18899	18899	18899
	S	-	-	-	-	-	-	-	-	-	-	-	-	-	-	-	-	-
20	T	18899	10015	5008	3338	2504	2003	1669	1431	1252	1113	1002	910	835	770	715	668	626
	S	-	250	125	83	62	50	41	35	31	27	25	22	20	19	17	16	15
40	T	18899	18900	10015	6677	5008	4006	3338	2861	2504	2226	2003	1821	1669	1541	1431	1335	1252
	S	-	501	250	167	125	100	83	71	62	55	50	45	41	38	35	33	31
60	T	18899	18900	15023	10015	7511	6009	5008	4292	3756	3338	3005	2731	2504	2311	2146	2003	1878
	S	-	751	375	250	187	150	125	107	93	83	75	68	62	57	53	50	46
80	T	18899	18900	18900	13353	10015	8012	6677	5723	5008	4451	4006	3642	3338	3082	2861	2671	2504
	S	-	1002	501	334	250	200	167	143	125	111	100	91	83	77	71	66	62
100	T	18899	18900	18900	16692	12519	10015	8346	7154	6259	5564	5008	4552	4173	3852	3577	3338	3130
	S	-	1253	626	417	313	250	208	179	156	139	125	113	104	96	89	83	78
120	T	18899	18900	18900	18900	15023	12018	10015	8584	7511	6677	6009	5463	5008	4622	4292	4006	3756
	S	-	1503	751	501	375	300	250	214	187	167	150	136	125	115	107	100	93
140	T	18899	18900	18900	18900	17526	14021	11684	10015	8763	7789	7011	6373	5842	5393	5008	4674	4382
	S	-	1754	877	584	438	350	292	250	219	194	175	159	146	134	125	116	109
160	T	18899	18900	18900	18900	18900	16024	13353	11446	10015	8902	8012	7284	6677	6163	5723	5341	5008
	S	-	2004	1002	668	501	400	334	286	250	222	200	182	167	154	143	133	125
180	T	18899	18900	18900	18900	18900	18027	15023	12876	11267	10015	9014	8194	7511	6933	6438	6009	5633
	S	-	2255	1127	751	563	451	375	322	281	250	225	205	187	173	161	150	140
200	T	18899	18900	18900	18900	18900	16692	14307	12519	11128	10015	9105	8346	7704	7154	6677	6259	5885
	S	-	2506	1253	835	626	501	417	358	313	278	250	227	208	192	179	167	156
220	T	18899	18900	18900	18900	18900	18361	15738	13771	12241	11017	10015	9180	8474	7869	7344	6885	6485
	S	-	2756	1378	918	689	551	459	393	344	306	275	250	229	212	196	183	172
240	T	18899	18900	18900	18900	18900	18900	17169	15023	13353	12018	10925	10015	9245	8584	8012	7511	7011
	S	-	3007	1503	1002	751	601	501	429	375	334	300	273	250	231	214	200	187
$k_t \times b (-)$		0,0	192,7	385,5	578,2	770,9	963,6	1156,4	1349,1	1541,8	1734,5	1927,3	2120,0	2312,7	2505,5	2698,2	2890,9	3083,6

TTM: Timber-Timber-Maximum | TTP: Timber-Timber-Partial | TCM: Timber-Concrete-Maximum | TCP: Timber-Concrete-Partial

T: $F_{1,T,Rk}$ load-carrying capacity of timber | S: $F_{1,S,Rk}$ load-carrying capacity of steel

Table B.5 Angle bracket type 5501S, Variant TCM, Fastener GH Screw 5x60, Density 350 kg/m³

Characteristic load-carrying capacity $F_{1,Rk}$ (N) for one / two angle brackets															
angle bracket	1													2	
f (mm)	0	10	20	30	40	50	60	70	80	90	100	110	120	0	
$F_{1,Rk}$	T	11325	2646	1323	882	662	529	441	378	331	294	265	241	221	22650
	S	250	210	181	160	142	128	117	107	99	92	86	81	76	500
k_t (-)	9,6	11,5	13,3	15,1	16,9	18,7	20,5	22,4	24,2	26,0	27,8	29,6	31,5	4,8	

Characteristic load-carrying capacity $F_{2/3,Rk}$ (N) for one / two angle brackets			
angle bracket	1	2	
$F_{2/3,Rk}$	T	2740	5480
	S	-	-

Characteristic load-carrying capacity $F_{4,Rk}$ (N) for one angle bracket																	
e (mm)	0	20	40	60	80	100	120	140	160	180	200	220	240	260	280	300	320
$F_{4,Rk}$	T	-	-	13230	1203	630	427	323	259	217	186	163	145	131	109	101	94
	S	-	664	332	221	166	132	110	94	83	73	66	60	55	51	47	44
k_t (-)	0,0	3,6	7,3	10,9	14,5	18,2	21,8	25,5	29,1	32,7	36,4	40,0	43,6	47,3	50,9	54,5	58,2

Characteristic load-carrying capacity $F_{5,Rk}$ (N) for one angle bracket																		
b / e (mm)	0	20	40	60	80	100	120	140	160	180	200	220	240	260	280	300	320	
0	T	696	1470	4925	3283	2462	1970	1642	1407	1231	1094	985	895	821	758	704	657	616
	S	405	856	2867	1911	1433	1147	955	819	716	637	573	521	477	441	409	382	358
20	T	696	1470	4816	3211	2409	1926	1606	1376	1205	1070	964	876	804	741	689	643	603
	S	405	856	2867	1911	1433	1147	955	819	716	637	573	521	477	441	409	382	358
40	T	696	1470	4925	3283	2462	1970	1642	1407	1231	1094	985	895	821	758	704	657	616
	S	405	856	2867	1911	1433	1147	955	819	716	637	573	521	477	441	409	382	358
60	T	696	1470	4925	3283	2462	1970	1642	1407	1231	1094	985	895	821	758	704	657	616
	S	405	856	2867	1911	1433	1147	955	819	716	637	573	521	477	441	409	382	358
80	T	696	1470	4925	3283	2462	1970	1642	1407	1231	1094	985	895	821	758	704	657	616
	S	405	856	2867	1911	1433	1147	955	819	716	637	573	521	477	441	409	382	358
100	T	696	1470	4925	3283	2462	1970	1642	1407	1231	1094	985	895	821	758	704	657	616
	S	405	856	2867	1911	1433	1147	955	819	716	637	573	521	477	441	409	382	358
120	T	696	1470	4925	3283	2462	1970	1642	1407	1231	1094	985	895	821	758	704	657	616
	S	405	856	2867	1911	1433	1147	955	819	716	637	573	521	477	441	409	382	358
140	T	696	1470	4925	3283	2462	1970	1642	1407	1231	1094	985	895	821	758	704	657	616
	S	405	856	2867	1911	1433	1147	955	819	716	637	573	521	477	441	409	382	358
160	T	696	1470	4925	3283	2462	1970	1642	1407	1231	1094	985	895	821	758	704	657	616
	S	405	856	2867	1911	1433	1147	955	819	716	637	573	521	477	441	409	382	358
180	T	696	1470	4925	3283	2462	1970	1642	1407	1231	1094	985	895	821	758	704	657	616
	S	405	856	2867	1911	1433	1147	955	819	716	637	573	521	477	441	409	382	358
200	T	696	1470	4925	3283	2462	1970	1642	1407	1231	1094	985	895	821	758	704	657	616
	S	405	856	2867	1911	1433	1147	955	819	716	637	573	521	477	441	409	382	358
220	T	696	1470	4925	3283	2462	1970	1642	1407	1231	1094	985	895	821	758	704	657	616
	S	405	856	2867	1911	1433	1147	955	819	716	637	573	521	477	441	409	382	358
240	T	696	1470	4925	3283	2462	1970	1642	1407	1231	1094	985	895	821	758	704	657	616
	S	405	856	2867	1911	1433	1147	955	819	716	637	573	521	477	441	409	382	358
$k_x \times b$ (-)	0,0	16,7	33,4	50,1	66,8	83,5	100,2	116,9	133,6	150,3	167,0	183,7	200,3	217,0	233,7	250,4	267,1	

Characteristic load-carrying capacity $F_{4/5,Rk}$ (N) for two angle brackets																		
b / e (mm)	0	20	40	60	80	100	120	140	160	180	200	220	240	260	280	300	320	
0	T	29399	29399	29399	29399	29399	29399	29399	29399	29399	29399	29399	29399	29399	29399	29399	29399	
	S	-	-	-	-	-	-	-	-	-	-	-	-	-	-	-	-	
20	T	29399	11325	5663	3775	2831	2265	1888	1618	1416	1258	1133	1030	944	871	809	755	708
	S	-	250	125	83	62	50	41	35	31	27	25	22	20	19	17	16	15
40	T	29399	22650	11325	7550	5663	4530	3775	3236	2831	2517	2265	2059	1888	1742	1618	1510	1416
	S	-	501	250	167	125	100	83	71	62	55	50	45	41	38	35	33	31
60	T	29399	29400	16988	11325	8494	6795	5663	4854	4247	3775	3398	3089	2831	2613	2427	2265	2123
	S	-	751	375	250	187	150	125	107	93	83	75	68	62	57	53	50	46
80	T	29399	29400	22650	15100	11325	9060	7550	6471	5663	5033	4530	4118	3775	3485	3236	3020	2831
	S	-	1002	501	334	250	200	167	143	125	111	100	91	83	77	71	66	62
100	T	29399	29400	28313	18875	14156	11325	9438	8089	7078	6292	5663	5148	4719	4356	4045	3775	3539
	S	-	1253	626	417	313	250	208	179	156	139	125	113	104	96	89	83	78
120	T	29399	29400	29400	22650	16988	13590	11325	9707	8494	7550	6795	6177	5663	5227	4854	4530	4247
	S	-	1503	751	501	375	300	250	214	187	167	150	136	125	115	107	100	93
140	T	29399	29400	29400	26425	19819	15855	13213	11325	9909	8808	7928	7207	6606	6098	5663	5285	4955
	S	-	1754	877	584	438	350	292	250	219	194	175	159	146	134	125	116	109
160	T	29399	29400	29400	29400	22650	18120	15100	12943	11325	10067	9060	8236	7550	6969	6471	6040	5663
	S	-	2004	1002	668	501	400	334	286	250	222	200	182	167	154	143	133	125
180	T	29399	29400	29400	29400	25481	20385	16988	14561	12741	11325	10193	9266	8494	7840	7280	6795	6370
	S	-	2255	1127	751	563	451	375	322	281	250	225	205	187	173	161	150	140
200	T	29399	29400	29400	29400	28313	22650	18875	16179	14156	12583	11325	10295	9438	8712	8089	7550	7078
	S	-	2506	1253	835	626	501	417	358	313	278	250	227	208	192	179	167	156
220	T	29399	29400	29400	29400	29400	24915	20763	17796	15572	13842	12458	11325	10381	9583	8898	8305	7786
	S	-	2756	1378	918	689	551	459	393	344	306	275	250	229	212	196	183	172
240	T	29399	29400	29400	29400	29400	27180	22650	19414	16988	15100	13590	12355	11325	10454	9707	9060	8494
	S	-	3007	1503	1002	751	601	501	429	375	334	300	273	250	231	214	200	187
$k_x \times b$ (-)	0,0	192,7	385,5	578,2	770,9	963,6	1156,4	1349,1	1541,8	1734,5	1927,3	2120,0	2312,7	2505,5	2698,2	2890,9	3083,6	

TTM: Timber-Timber-Maximum | TTP: Timber-Timber-Partial | TCM: Timber-Concrete-Maximum | TCP: Timber-Concrete-Partial

T: $F_{1,T,Rk}$ load-carrying capacity of timber | S: $F_{1,S,Rk}$ load-carrying capacity of steel

Table B.6 Angle bracket type 5501S, Variant TCP, Fastener GH Nail 4x40, Density 350 kg/m³Characteristic load-carrying capacity $F_{1,Rk}$ (N) for one / two angle brackets

angle bracket		1													2
f (mm)		0	10	20	30	40	50	60	70	80	90	100	110	120	0
$F_{1,Rk}$	T	7560	810	405	270	203	162	135	116	101	89	80	73	67	15120
	S	250	210	181	160	142	128	117	107	99	93	87	81	77	500
$k_t (-)$		9,6	11,5	13,3	15,1	16,9	18,7	20,5	22,4	24,2	26,0	27,8	29,6	31,5	4,8

Characteristic load-carrying capacity $F_{2/3,Rk}$ (N) for one / two angle brackets

angle bracket		1	2
$F_{2/3,Rk}$	T	1130	2260
	S	-	-

Characteristic load-carrying capacity $F_{4,Rk}$ (N) for one angle bracket

e (mm)		0	20	40	60	80	100	120	140	160	180	200	220	240	260	280	300	320
$F_{4,Rk}$	T	-	-	4050	368	193	130	98	79	66	57	49	44	40	36	33	30	28
	S	-	664	332	221	166	133	111	95	83	74	66	60	55	51	47	44	42
$k_t (-)$		0,0	3,6	7,3	10,9	14,5	18,2	21,8	25,5	29,1	32,7	36,4	40,0	43,6	47,3	50,9	54,5	58,2

Characteristic load-carrying capacity $F_{5,Rk}$ (N) for one angle bracket

b / e (mm)		0	20	40	60	80	100	120	140	160	180	200	220	240	260	280	300	320
0	T	213	449	1507	1004	753	602	502	430	376	334	301	274	251	231	215	200	188
	S	405	856	2868	1912	1434	1147	956	819	717	637	574	521	478	441	410	382	358
20	T	213	449	1400	933	700	560	466	400	350	311	280	254	233	215	200	186	175
	S	405	856	2868	1912	1434	1147	956	819	717	637	574	521	478	441	410	382	358
40	T	213	449	1478	985	739	591	492	422	369	328	295	268	246	227	211	197	184
	S	405	856	2868	1912	1434	1147	956	819	717	637	574	521	478	441	410	382	358
60	T	213	449	1494	996	747	597	498	426	373	332	298	271	249	229	213	199	186
	S	405	856	2868	1912	1434	1147	956	819	717	637	574	521	478	441	410	382	358
80	T	213	449	1500	1000	750	600	500	428	375	333	300	272	250	230	214	200	187
	S	405	856	2868	1912	1434	1147	956	819	717	637	574	521	478	441	410	382	358
100	T	213	449	1502	1001	751	601	500	429	375	333	300	273	250	231	214	200	187
	S	405	856	2868	1912	1434	1147	956	819	717	637	574	521	478	441	410	382	358
120	T	213	449	1504	1002	752	601	501	429	376	334	300	273	250	231	214	200	188
	S	405	856	2868	1912	1434	1147	956	819	717	637	574	521	478	441	410	382	358
140	T	213	449	1505	1003	752	602	501	430	376	334	301	273	250	231	215	200	188
	S	405	856	2868	1912	1434	1147	956	819	717	637	574	521	478	441	410	382	358
160	T	213	449	1505	1003	752	602	501	430	376	334	301	273	250	231	215	200	188
	S	405	856	2868	1912	1434	1147	956	819	717	637	574	521	478	441	410	382	358
180	T	213	449	1506	1004	753	602	502	430	376	334	301	273	251	231	215	200	188
	S	405	856	2868	1912	1434	1147	956	819	717	637	574	521	478	441	410	382	358
200	T	213	449	1506	1004	753	602	502	430	376	334	301	273	251	231	215	200	188
	S	405	856	2868	1912	1434	1147	956	819	717	637	574	521	478	441	410	382	358
220	T	213	449	1506	1004	753	602	502	430	376	334	301	273	251	231	215	200	188
	S	405	856	2868	1912	1434	1147	956	819	717	637	574	521	478	441	410	382	358
240	T	213	449	1506	1004	753	602	502	430	376	334	301	273	251	231	215	200	188
	S	405	856	2868	1912	1434	1147	956	819	717	637	574	521	478	441	410	382	358
$k_t \times b (-)$		0,0	16,7	33,4	50,1	66,8	83,5	100,2	116,9	133,6	150,3	167,0	183,7	200,3	217,0	233,7	250,4	267,1

Characteristic load-carrying capacity $F_{4/5,Rk}$ (N) for two angle brackets

b / e (mm)		0	20	40	60	80	100	120	140	160	180	200	220	240	260	280	300	320	
0	T	7199	7199	7199	7199	7199	7199	7199	7199	7199	7199	7199	7199	7199	7199	7199	7199	7199	
	S	-	-	-	-	-	-	-	-	-	-	-	-	-	-	-	-	-	
20	T	7199	7200	3780	2520	1890	1512	1260	1080	945	840	756	687	630	582	540	504	473	
	S	-	250	125	83	62	50	41	35	31	27	25	22	20	19	17	16	15	
40	T	7199	7200	7200	5040	3780	3024	2520	2160	1890	1680	1512	1375	1260	1163	1080	1008	945	
	S	-	501	250	167	125	100	83	71	62	55	50	45	41	38	35	33	31	
60	T	7199	7200	7200	7200	5670	4536	3780	3240	2835	2520	2268	2062	1890	1745	1620	1512	1418	
	S	-	751	375	250	187	150	125	107	93	83	75	68	62	57	53	50	46	
80	T	7199	7200	7200	7200	7200	6048	5040	4320	3780	3360	3024	2749	2520	2326	2160	2016	1890	
	S	-	1002	501	334	250	200	167	143	125	111	100	91	83	77	71	66	62	
100	T	7199	7200	7200	7200	7200	7200	6300	5400	4725	4200	3780	3436	3150	2908	2700	2520	2363	
	S	-	1253	626	417	313	250	208	179	156	139	125	113	104	96	89	83	78	
120	T	7199	7200	7200	7200	7200	7200	7200	6480	5670	5040	4536	4124	3780	3489	3240	3024	2835	
	S	-	1503	751	501	375	300	250	214	187	167	150	136	125	115	107	100	93	
140	T	7199	7200	7200	7200	7200	7200	7200	7200	6615	5880	5292	4811	4410	4071	3780	3528	3308	
	S	-	1754	877	584	438	350	292	250	219	194	175	159	146	134	125	116	109	
160	T	7199	7200	7200	7200	7200	7200	7200	7200	7200	6720	6048	5498	5040	4652	4320	4032	3780	
	S	-	2004	1002	668	501	400	334	286	250	222	200	182	167	154	143	133	125	
180	T	7199	7200	7200	7200	7200	7200	7200	7200	7200	7200	7200	6804	6185	5670	5234	4860	4536	4253
	S	-	2255	1127	751	563	451	375	322	281	250	225	205	187	173	161	150	140	
200	T	7199	7200	7200	7200	7200	7200	7200	7200	7200	7200	7200	7200	6873	6300	5815	5400	5040	4725
	S	-	2506	1253	835	626	501	417	358	313	278	250	227	208	192	179	167	156	
220	T	7199	7200	7200	7200	7200	7200	7200	7200	7200	7200	7200	7200	7200	6930	6397	5940	5544	5198
	S	-	2756	1378	918	689	551	459	393	344	306	275	250	229	212	196	183	172	
240	T	7199	7200	7200	7200	7200	7200	7200	7200	7200	7200	7200	7200	7200	6978	6480	6048	5670	
	S	-	3007	1503	1002	751	601	501	429	375	334	300	273	250	231	214	200	187	
$k_t \times b (-)$		0,0	192,7	385,5	578,2	770,9	963,6	1156,4	1349,1	1541,8	1734,5	1927,3	2120,0	2312,7	2505,5	2698,2	2890,9	3083,6	

TTM: Timber-Timber-Maximum | TTP: Timber-Timber-Partial | TCM: Timber-Concrete-Maximum | TCP: Timber-Concrete-Partial

T: $F_{1,T,Rk}$ load-carrying capacity of timber | S: $F_{1,S,Rk}$ load-carrying capacity of steel

Table B. 7 Angle bracket type 5501S, Variant TCP, Fastener GH Nail 4x60, Density 350 kg/m³Characteristic load-carrying capacity $F_{1,Rk}$ (N) for one / two angle brackets

angle bracket		1													2
f (mm)		0	10	20	30	40	50	60	70	80	90	100	110	120	0
$F_{1,Rk}$	T	9456	1350	675	450	338	270	225	193	169	150	135	123	113	18912
	S	250	210	181	160	142	128	117	107	99	92	86	81	76	500
k_t (-)		9,6	11,5	13,3	15,1	16,9	18,7	20,5	22,4	24,2	26,0	27,8	29,6	31,5	4,8

Characteristic load-carrying capacity $F_{2/3,Rk}$ (N) for one / two angle brackets

angle bracket		1	2
$F_{2/3,Rk}$	T	1740	3480
	S	-	-

Characteristic load-carrying capacity $F_{4,Rk}$ (N) for one angle bracket

e (mm)		0	20	40	60	80	100	120	140	160	180	200	220	240	260	280	300	320
$F_{4,Rk}$	T	-	-	6750	614	321	218	165	132	111	95	83	74	67	61	56	52	48
	S	-	664	332	221	166	132	110	94	83	73	66	60	55	51	47	44	41
k_t (-)		0,0	3,6	7,3	10,9	14,5	18,2	21,8	25,5	29,1	32,7	36,4	40,0	43,6	47,3	50,9	54,5	58,2

Characteristic load-carrying capacity $F_{5,Rk}$ (N) for one angle bracket

b / e (mm)		0	20	40	60	80	100	120	140	160	180	200	220	240	260	280	300	320
0	T	355	749	2512	1675	1256	1005	837	717	628	558	502	456	418	386	358	334	314
	S	405	856	2868	1912	1434	1147	956	819	717	637	574	521	478	441	410	382	358
20	T	355	749	2218	1479	1109	887	739	633	554	493	443	403	369	341	316	295	277
	S	405	856	2868	1912	1434	1147	956	819	717	637	574	521	478	441	410	382	358
40	T	355	749	2428	1618	1214	971	809	693	607	539	485	441	404	373	346	323	303
	S	405	856	2868	1912	1434	1147	956	819	717	637	574	521	478	441	410	382	358
60	T	355	749	2473	1649	1236	989	824	706	618	549	494	449	412	380	353	329	309
	S	405	856	2868	1912	1434	1147	956	819	717	637	574	521	478	441	410	382	358
80	T	355	749	2490	1660	1245	996	830	711	622	553	498	452	415	383	355	332	311
	S	405	856	2868	1912	1434	1147	956	819	717	637	574	521	478	441	410	382	358
100	T	355	749	2498	1665	1249	999	832	713	624	555	499	454	416	384	356	333	312
	S	405	856	2868	1912	1434	1147	956	819	717	637	574	521	478	441	410	382	358
120	T	355	749	2502	1668	1251	1001	834	715	625	556	500	455	417	385	357	333	312
	S	405	856	2868	1912	1434	1147	956	819	717	637	574	521	478	441	410	382	358
140	T	355	749	2505	1670	1252	1002	835	715	626	556	501	455	417	385	357	334	313
	S	405	856	2868	1912	1434	1147	956	819	717	637	574	521	478	441	410	382	358
160	T	355	749	2506	1671	1253	1002	835	716	626	557	501	455	417	385	358	334	313
	S	405	856	2868	1912	1434	1147	956	819	717	637	574	521	478	441	410	382	358
180	T	355	749	2508	1672	1254	1003	836	716	627	557	501	456	418	385	358	334	313
	S	405	856	2868	1912	1434	1147	956	819	717	637	574	521	478	441	410	382	358
200	T	355	749	2508	1672	1254	1003	836	716	627	557	501	456	418	385	358	334	313
	S	405	856	2868	1912	1434	1147	956	819	717	637	574	521	478	441	410	382	358
220	T	355	749	2509	1673	1254	1003	836	717	627	557	501	456	418	386	358	334	313
	S	405	856	2868	1912	1434	1147	956	819	717	637	574	521	478	441	410	382	358
240	T	355	749	2510	1673	1255	1004	836	717	627	557	502	456	418	386	358	334	313
	S	405	856	2868	1912	1434	1147	956	819	717	637	574	521	478	441	410	382	358
$k_x \times b$ (-)		0,0	16,7	33,4	50,1	66,8	83,5	100,2	116,9	133,6	150,3	167,0	183,7	200,3	217,0	233,7	250,4	267,1

Characteristic load-carrying capacity $F_{4/5,Rk}$ (N) for two angle brackets

b / e (mm)		0	20	40	60	80	100	120	140	160	180	200	220	240	260	280	300	320
0	T	12000	12000	12000	12000	12000	12000	12000	12000	12000	12000	12000	12000	12000	12000	12000	12000	12000
	S	-	-	-	-	-	-	-	-	-	-	-	-	-	-	-	-	-
20	T	12000	9456	4728	3152	2364	1891	1576	1351	1182	1051	946	860	788	727	675	630	591
	S	-	250	125	83	62	50	41	35	31	27	25	22	20	19	17	16	15
40	T	12000	12000	9456	6304	4728	3782	3152	2702	2364	2101	1891	1719	1576	1455	1351	1261	1182
	S	-	501	250	167	125	100	83	71	62	55	50	45	41	38	35	33	31
60	T	12000	12000	12000	9456	7092	5674	4728	4053	3546	3152	2837	2579	2364	2182	2026	1891	1773
	S	-	751	375	250	187	150	125	107	93	83	75	68	62	57	53	50	46
80	T	12000	12000	12000	12000	9456	7565	6304	5403	4728	4203	3782	3439	3152	2910	2702	2522	2364
	S	-	1002	501	334	250	200	167	143	125	111	100	91	83	77	71	66	62
100	T	12000	12000	12000	12000	11820	9456	7880	6754	5910	5253	4728	4298	3940	3637	3377	3152	2955
	S	-	1253	626	417	313	250	208	179	156	139	125	113	104	96	89	83	78
120	T	12000	12000	12000	12000	11347	9456	8105	7092	6304	5674	5158	4728	4364	4053	3782	3546	3346
	S	-	1503	751	501	375	300	250	214	187	167	150	136	125	115	107	100	93
140	T	12000	12000	12000	12000	12000	11032	9456	8274	7355	6619	6017	5516	5092	4728	4413	4137	3917
	S	-	1754	877	584	438	350	292	250	219	194	175	159	146	134	125	116	109
160	T	12000	12000	12000	12000	12000	12000	10807	9456	8405	7565	6877	6304	5819	5403	5043	4728	4478
	S	-	2004	1002	668	501	400	334	286	250	222	200	182	167	154	143	133	125
180	T	12000	12000	12000	12000	12000	12000	12000	10638	9456	8510	7737	7092	6546	6079	5674	5319	5019
	S	-	2255	1127	751	563	451	375	322	281	250	225	205	187	173	161	150	140
200	T	12000	12000	12000	12000	12000	12000	12000	11820	10507	9456	8596	7880	7274	6754	6304	5910	5510
	S	-	2506	1253	835	626	501	417	358	313	278	250	227	208	192	179	167	156
220	T	12000	12000	12000	12000	12000	12000	12000	12000	11557	10402	9456	8668	8001	7430	6934	6501	6101
	S	-	2756	1378	918	689	551	459	393	344	306	275	250	229	212	196	183	172
240	T	12000	12000	12000	12000	12000	12000	12000	12000	12000	11347	10316	9456	8729	8105	7565	7092	6692
	S	-	3007	1503	1002	751	601	501	429	375	334	300	273	250	231	214	200	187
$k_x \times b$ (-)		0,0	192,7	385,5	578,2	770,9	963,6	1156,4	1349,1	1541,8	1734,5	1927,3	2120,0	2312,7	2505,5	2698,2	2890,9	3083,6

TTM: Timber-Timber-Maximum | TTP: Timber-Timber-Partial | TCM: Timber-Concrete-Maximum | TCP: Timber-Concrete-Partial

T: $F_{1,T,Rk}$ load-carrying capacity of timber | S: $F_{1,S,Rk}$ load-carrying capacity of steel

Table B. 8 Angle bracket type 5501S, Variant TCP, Fastener GH Screw 5x40, Density 350 kg/m³Characteristic load-carrying capacity $F_{1,Rk}$ (N) for one / two angle brackets

angle bracket		1													2
f (mm)		0	10	20	30	40	50	60	70	80	90	100	110	120	0
$F_{1,Rk}$	T	8012	1701	850	567	425	340	284	243	213	189	170	155	142	16024
	S	250	210	181	160	142	128	117	107	99	92	86	81	76	500
k_t (-)		9,6	11,5	13,3	15,1	16,9	18,7	20,5	22,4	24,2	26,0	27,8	29,6	31,5	4,8

Characteristic load-carrying capacity $F_{2/3,Rk}$ (N) for one / two angle brackets

angle bracket		1	2
$F_{2/3,Rk}$	T	1850	3700
	S	-	-

Characteristic load-carrying capacity $F_{4,Rk}$ (N) for one angle bracket

e (mm)		0	20	40	60	80	100	120	140	160	180	200	220	240	260	280	300	320
$F_{4,Rk}$	T	-	-	8505	773	405	274	207	167	139	120	105	93	84	77	70	65	60
	S	-	664	332	221	166	132	110	94	83	73	66	60	55	51	47	44	41
k_t (-)		0,0	3,6	7,3	10,9	14,5	18,2	21,8	25,5	29,1	32,7	36,4	40,0	43,6	47,3	50,9	54,5	58,2

Characteristic load-carrying capacity $F_{5,Rk}$ (N) for one angle bracket

b / e (mm)		0	20	40	60	80	100	120	140	160	180	200	220	240	260	280	300	320
0	T	448	945	3166	2111	1583	1266	1055	905	791	704	633	576	528	487	452	422	396
	S	405	856	2867	1911	1433	1147	955	819	716	637	573	521	477	441	409	382	358
20	T	448	945	2483	1655	1241	993	827	709	620	551	496	451	413	382	354	331	310
	S	405	856	2868	1912	1434	1147	956	819	717	637	574	521	478	441	410	382	358
40	T	448	945	3024	2016	1512	1209	1009	864	757	672	605	550	505	465	433	403	378
	S	405	856	2867	1911	1433	1147	955	819	716	637	573	521	477	441	409	382	358
60	T	448	945	3166	2111	1583	1266	1055	905	791	704	633	576	528	487	452	422	396
	S	405	856	2867	1911	1433	1147	955	819	716	637	573	521	477	441	409	382	358
80	T	448	945	3166	2111	1583	1266	1055	905	791	704	633	576	528	487	452	422	396
	S	405	856	2867	1911	1433	1147	955	819	716	637	573	521	477	441	409	382	358
100	T	448	945	3166	2111	1583	1266	1055	905	791	704	633	576	528	487	452	422	396
	S	405	856	2867	1911	1433	1147	955	819	716	637	573	521	477	441	409	382	358
120	T	448	945	3166	2111	1583	1266	1055	905	791	704	633	576	528	487	452	422	396
	S	405	856	2867	1911	1433	1147	955	819	716	637	573	521	477	441	409	382	358
140	T	448	945	3166	2111	1583	1266	1055	905	791	704	633	576	528	487	452	422	396
	S	405	856	2867	1911	1433	1147	955	819	716	637	573	521	477	441	409	382	358
160	T	448	945	3166	2111	1583	1266	1055	905	791	704	633	576	528	487	452	422	396
	S	405	856	2867	1911	1433	1147	955	819	716	637	573	521	477	441	409	382	358
180	T	448	945	3166	2111	1583	1266	1055	905	791	704	633	576	528	487	452	422	396
	S	405	856	2867	1911	1433	1147	955	819	716	637	573	521	477	441	409	382	358
200	T	448	945	3166	2111	1583	1266	1055	905	791	704	633	576	528	487	452	422	396
	S	405	856	2867	1911	1433	1147	955	819	716	637	573	521	477	441	409	382	358
220	T	448	945	3166	2111	1583	1266	1055	905	791	704	633	576	528	487	452	422	396
	S	405	856	2867	1911	1433	1147	955	819	716	637	573	521	477	441	409	382	358
240	T	448	945	3166	2111	1583	1266	1055	905	791	704	633	576	528	487	452	422	396
	S	405	856	2867	1911	1433	1147	955	819	716	637	573	521	477	441	409	382	358
$k_t \times b$ (-)		0,0	16,7	33,4	50,1	66,8	83,5	100,2	116,9	133,6	150,3	167,0	183,7	200,3	217,0	233,7	250,4	267,1

Characteristic load-carrying capacity $F_{4/5,Rk}$ (N) for two angle brackets

b / e (mm)		0	20	40	60	80	100	120	140	160	180	200	220	240	260	280	300	320
0	T	15120	15120	15120	15120	15120	15120	15120	15120	15120	15120	15120	15120	15120	15120	15120	15120	15120
	S	-	-	-	-	-	-	-	-	-	-	-	-	-	-	-	-	-
20	T	15120	8012	4006	2671	2003	1602	1335	1145	1002	890	801	728	668	616	572	534	501
	S	-	250	125	83	62	50	41	35	31	27	25	22	20	19	17	16	15
40	T	15120	15120	8012	5341	4006	3205	2671	2289	2003	1780	1602	1457	1335	1233	1145	1068	1002
	S	-	501	250	167	125	100	83	71	62	55	50	45	41	38	35	33	31
60	T	15120	15120	12018	8012	6009	4807	4006	3434	3005	2671	2404	2185	2003	1849	1717	1602	1502
	S	-	751	375	250	187	150	125	107	93	83	75	68	62	57	53	50	46
80	T	15120	15120	15120	10683	8012	6410	5341	4578	4006	3561	3205	2913	2671	2465	2289	2137	2003
	S	-	1002	501	334	250	200	167	143	125	111	100	91	83	77	71	66	62
100	T	15120	15120	15120	13353	10015	8012	6677	5723	5008	4451	4006	3642	3338	3082	2861	2671	2504
	S	-	1253	626	417	313	250	208	179	156	139	125	113	104	96	89	83	78
120	T	15120	15120	15120	15120	12018	9614	8012	6867	6009	5341	4807	4370	4006	3698	3434	3205	3005
	S	-	1503	751	501	375	300	250	214	187	167	150	136	125	115	107	100	93
140	T	15120	15120	15120	15120	14021	11217	9347	8012	7011	6232	5608	5099	4674	4314	4006	3739	3505
	S	-	1754	877	584	438	350	292	250	219	194	175	159	146	134	125	116	109
160	T	15120	15120	15120	15120	15120	12819	10683	9157	8012	7122	6410	5827	5341	4930	4578	4273	4006
	S	-	2004	1002	668	501	400	334	286	250	222	200	182	167	154	143	133	125
180	T	15120	15120	15120	15120	15120	14422	12018	10301	9014	8012	7211	6555	6009	5547	5151	4807	4507
	S	-	2255	1127	751	563	451	375	322	281	250	225	205	187	173	161	150	140
200	T	15120	15120	15120	15120	15120	15120	13353	11446	10015	8902	8012	7284	6677	6163	5723	5341	5008
	S	-	2506	1253	835	626	501	417	358	313	278	250	227	208	192	179	167	156
220	T	15120	15120	15120	15120	15120	15120	14689	12590	11017	9792	8813	8012	7344	6779	6295	5875	5508
	S	-	2756	1378	918	689	551	459	393	344	306	275	250	229	212	196	183	172
240	T	15120	15120	15120	15120	15120	15120	15120	13735	12018	10683	9614	8740	8012	7396	6867	6410	6009
	S	-	3007	1503	1002	751	601	501	429	375	334	300	273	250	231	214	200	187
$k_t \times b$ (-)		0,0	192,7	385,5	578,2	770,9	963,6	1156,4	1349,1	1541,8	1734,5	1927,3	2120,0	2312,7	2505,5	2698,2	2890,9	3083,6

TTM: Timber-Timber-Maximum | TTP: Timber-Timber-Partial | TCM: Timber-Concrete-Maximum | TCP: Timber-Concrete-Partial

T: $F_{1,T,Rk}$ load-carrying capacity of timber | S: $F_{1,S,Rk}$ load-carrying capacity of steel

Table B.9 Angle bracket type 5501S, Variant TCP, Fastener GH Screw 5x60, Density 350 kg/m³Characteristic load-carrying capacity $F_{1,Rk}$ (N) for one / two angle brackets

angle bracket		1													2
f (mm)		0	10	20	30	40	50	60	70	80	90	100	110	120	0
$F_{1,Rk}$	T	9060	2646	1323	882	662	529	441	378	331	294	265	241	221	18120
	S	250	210	181	160	142	128	117	107	99	92	86	81	76	500
k_t (-)		9,6	11,5	13,3	15,1	16,9	18,7	20,5	22,4	24,2	26,0	27,8	29,6	31,5	4,8

Characteristic load-carrying capacity $F_{2/3,Rk}$ (N) for one / two angle brackets

angle bracket		1	2
$F_{2/3,Rk}$	T	2380	4760
	S	-	-

Characteristic load-carrying capacity $F_{4,Rk}$ (N) for one angle bracket

e (mm)		0	20	40	60	80	100	120	140	160	180	200	220	240	260	280	300	320
$F_{4,Rk}$	T	-	-	13230	1203	630	427	323	259	217	186	163	145	131	119	109	101	94
	S	-	664	332	221	166	132	110	94	83	73	66	60	55	51	47	44	41
k_t (-)		0,0	3,6	7,3	10,9	14,5	18,2	21,8	25,5	29,1	32,7	36,4	40,0	43,6	47,3	50,9	54,5	58,2

Characteristic load-carrying capacity $F_{5,Rk}$ (N) for one angle bracket

b / e (mm)		0	20	40	60	80	100	120	140	160	180	200	220	240	260	280	300	320
0	T	696	1470	4925	3283	2462	1970	1642	1407	1231	1094	985	895	821	758	704	657	616
	S	405	856	2867	1911	1433	1147	955	819	716	637	573	521	477	441	409	382	358
20	T	696	1470	3877	2585	1939	1551	1293	1108	970	862	776	705	647	597	555	517	485
	S	405	856	2867	1911	1433	1147	955	819	716	637	573	521	477	441	409	382	358
40	T	696	1470	4925	3283	2462	1970	1642	1407	1231	1094	985	895	821	758	704	657	616
	S	405	856	2867	1911	1433	1147	955	819	716	637	573	521	477	441	409	382	358
60	T	696	1470	4925	3283	2462	1970	1642	1407	1231	1094	985	895	821	758	704	657	616
	S	405	856	2867	1911	1433	1147	955	819	716	637	573	521	477	441	409	382	358
80	T	696	1470	4925	3283	2462	1970	1642	1407	1231	1094	985	895	821	758	704	657	616
	S	405	856	2867	1911	1433	1147	955	819	716	637	573	521	477	441	409	382	358
100	T	696	1470	4925	3283	2462	1970	1642	1407	1231	1094	985	895	821	758	704	657	616
	S	405	856	2867	1911	1433	1147	955	819	716	637	573	521	477	441	409	382	358
120	T	696	1470	4925	3283	2462	1970	1642	1407	1231	1094	985	895	821	758	704	657	616
	S	405	856	2867	1911	1433	1147	955	819	716	637	573	521	477	441	409	382	358
140	T	696	1470	4925	3283	2462	1970	1642	1407	1231	1094	985	895	821	758	704	657	616
	S	405	856	2867	1911	1433	1147	955	819	716	637	573	521	477	441	409	382	358
160	T	696	1470	4925	3283	2462	1970	1642	1407	1231	1094	985	895	821	758	704	657	616
	S	405	856	2867	1911	1433	1147	955	819	716	637	573	521	477	441	409	382	358
180	T	696	1470	4925	3283	2462	1970	1642	1407	1231	1094	985	895	821	758	704	657	616
	S	405	856	2867	1911	1433	1147	955	819	716	637	573	521	477	441	409	382	358
200	T	696	1470	4925	3283	2462	1970	1642	1407	1231	1094	985	895	821	758	704	657	616
	S	405	856	2867	1911	1433	1147	955	819	716	637	573	521	477	441	409	382	358
220	T	696	1470	4925	3283	2462	1970	1642	1407	1231	1094	985	895	821	758	704	657	616
	S	405	856	2867	1911	1433	1147	955	819	716	637	573	521	477	441	409	382	358
240	T	696	1470	4925	3283	2462	1970	1642	1407	1231	1094	985	895	821	758	704	657	616
	S	405	856	2867	1911	1433	1147	955	819	716	637	573	521	477	441	409	382	358
$k_x \times b$ (-)		0,0	16,7	33,4	50,1	66,8	83,5	100,2	116,9	133,6	150,3	167,0	183,7	200,3	217,0	233,7	250,4	267,1

Characteristic load-carrying capacity $F_{4/5,Rk}$ (N) for two angle brackets

b / e (mm)		0	20	40	60	80	100	120	140	160	180	200	220	240	260	280	300	320
0	T	23519	23519	23519	23519	23519	23519	23519	23519	23519	23519	23519	23519	23519	23519	23519	23519	23519
	S	-	-	-	-	-	-	-	-	-	-	-	-	-	-	-	-	-
20	T	23519	9060	4530	3020	2265	1812	1510	1294	1133	1007	906	824	755	697	647	604	566
	S	-	250	125	83	62	50	41	35	31	27	25	22	20	19	17	16	15
40	T	23519	18120	9060	6040	4530	3624	3020	2589	2265	2013	1812	1647	1510	1394	1294	1208	1133
	S	-	501	250	167	125	100	83	71	62	55	50	45	41	38	35	33	31
60	T	23519	23520	13590	9060	6795	5436	4530	3883	3398	3020	2718	2471	2265	2091	1941	1812	1699
	S	-	751	375	250	187	150	125	107	93	83	75	68	62	57	53	50	46
80	T	23519	23520	18120	12080	9060	7248	6040	5177	4530	4027	3624	3295	3020	2788	2589	2416	2265
	S	-	1002	501	334	250	200	167	143	125	111	100	91	83	77	71	66	62
100	T	23519	23520	22650	15100	11325	9060	7550	6471	5663	5033	4530	4118	3775	3485	3236	3020	2831
	S	-	1253	626	417	313	250	208	179	156	139	125	113	104	96	89	83	78
120	T	23519	23520	23520	18120	13590	10872	9060	7766	6795	6040	5436	4942	4530	4182	3883	3624	3398
	S	-	1503	751	501	375	300	250	214	187	167	150	136	125	115	107	100	93
140	T	23519	23520	23520	21140	15855	12684	10570	9060	7928	7047	6342	5765	5285	4878	4530	4228	3964
	S	-	1754	877	584	438	350	292	250	219	194	175	159	146	134	125	116	109
160	T	23519	23520	23520	23520	18120	14496	12080	10354	9060	8053	7248	6589	6040	5575	5177	4832	4530
	S	-	2004	1002	668	501	400	334	286	250	222	200	182	167	154	143	133	125
180	T	23519	23520	23520	23520	20385	16308	13590	11649	10193	9060	8154	7413	6795	6272	5824	5436	5096
	S	-	2255	1127	751	563	451	375	322	281	250	225	205	187	173	161	150	140
200	T	23519	23520	23520	23520	22650	18120	15100	12943	11325	10067	9060	8236	7550	6969	6471	6040	5663
	S	-	2506	1253	835	626	501	417	358	313	278	250	227	208	192	179	167	156
220	T	23519	23520	23520	23520	23520	19932	16610	14237	12458	11073	9966	9060	8305	7666	7119	6644	6229
	S	-	2756	1378	918	689	551	459	393	344	306	275	250	229	212	196	183	172
240	T	23519	23520	23520	23520	23520	21744	18120	15531	13590	12080	10872	9884	9060	8363	7766	7248	6795
	S	-	3007	1503	1002	751	601	501	429	375	334	300	273	250	231	214	200	187
$k_x \times b$ (-)		0,0	192,7	385,5	578,2	770,9	963,6	1156,4	1349,1	1541,8	1734,5	1927,3	2120,0	2312,7	2505,5	2698,2	2890,9	3083,6

TTM: Timber-Timber-Maximum | TTP: Timber-Timber-Partial | TCM: Timber-Concrete-Maximum | TCP: Timber-Concrete-Partial

T: $F_{1,T,Rk}$ load-carrying capacity of timber | S: $F_{1,S,Rk}$ load-carrying capacity of steel

Table B. 10 Angle bracket type 5501S, Variant TTM, Fastener GH Nail 4x40, Density 350 kg/m³Characteristic load-carrying capacity $F_{T,Rk}$ (N) for one / two angle brackets

angle bracket		1													2
f (mm)		0	10	20	30	40	50	60	70	80	90	100	110	120	0
$F_{T,Rk}$	T	1230	807	404	269	202	161	134	115	101	89	80	73	67	2460
	S	2107	1541	770	514	385	308	257	220	193	171	154	140	128	4214

Characteristic load-carrying capacity $F_{2/3,Rk}$ (N) for one / two angle brackets

angle bracket		1	2
$F_{2/3,Rk}$	T	3680	7360
	S	-	-

Characteristic load-carrying capacity $F_{4,Rk}$ (N) for one angle bracket

e (mm)		0	20	40	60	80	100	120	140	160	180	200	220	240	260	280	300	320
$F_{4,Rk}$	T	13230	2303	1164	368	192	130	98	79	66	57	49	44	40	36	33	30	28
	S	-	4003	2002	700	367	249	188	151	126	109	95	85	76	69	64	59	55

Characteristic load-carrying capacity $F_{5,Rk}$ (N) for one angle bracket

b / e (mm)		0	20	40	60	80	100	120	140	160	180	200	220	240	260	280	300	320
0	T	213	449	1507	1004	753	602	502	430	376	334	301	274	251	231	215	200	188
	S	405	856	2868	1912	1434	1147	956	819	717	637	574	521	478	441	410	382	358
20	T	213	449	1436	957	718	574	478	410	359	319	287	261	239	220	205	191	179
	S	405	856	2868	1912	1434	1147	956	819	717	637	574	521	478	441	410	382	358
40	T	213	449	1488	992	744	595	496	425	372	330	297	270	248	229	212	198	186
	S	405	856	2868	1912	1434	1147	956	819	717	637	574	521	478	441	410	382	358
60	T	213	449	1499	999	749	599	499	428	374	333	299	272	249	230	214	199	187
	S	405	856	2868	1912	1434	1147	956	819	717	637	574	521	478	441	410	382	358
80	T	213	449	1502	1001	751	601	500	429	375	333	300	273	250	231	214	200	187
	S	405	856	2868	1912	1434	1147	956	819	717	637	574	521	478	441	410	382	358
100	T	213	449	1504	1002	752	601	501	429	376	334	300	273	250	231	214	200	188
	S	405	856	2868	1912	1434	1147	956	819	717	637	574	521	478	441	410	382	358
120	T	213	449	1505	1003	752	602	501	430	376	334	301	273	250	231	215	200	188
	S	405	856	2868	1912	1434	1147	956	819	717	637	574	521	478	441	410	382	358
140	T	213	449	1505	1003	752	602	501	430	376	334	301	273	250	231	215	200	188
	S	405	856	2868	1912	1434	1147	956	819	717	637	574	521	478	441	410	382	358
160	T	213	449	1506	1004	753	602	502	430	376	334	301	273	251	231	215	200	188
	S	405	856	2868	1912	1434	1147	956	819	717	637	574	521	478	441	410	382	358
180	T	213	449	1506	1004	753	602	502	430	376	334	301	273	251	231	215	200	188
	S	405	856	2868	1912	1434	1147	956	819	717	637	574	521	478	441	410	382	358
200	T	213	449	1506	1004	753	602	502	430	376	334	301	273	251	231	215	200	188
	S	405	856	2868	1912	1434	1147	956	819	717	637	574	521	478	441	410	382	358
220	T	213	449	1506	1004	753	602	502	430	376	334	301	273	251	231	215	200	188
	S	405	856	2868	1912	1434	1147	956	819	717	637	574	521	478	441	410	382	358
240	T	213	449	1506	1004	753	602	502	430	376	334	301	273	251	231	215	200	188
	S	405	856	2868	1912	1434	1147	956	819	717	637	574	521	478	441	410	382	358

Characteristic load-carrying capacity $F_{4/5,Rk}$ (N) for two angle brackets

b / e (mm)		0	20	40	60	80	100	120	140	160	180	200	220	240	260	280	300	320
0	T	8999	8999	8999	8999	8999	8999	8999	8999	8999	8999	8999	8999	8999	8999	8999	8999	8999
	S	-	-	-	-	-	-	-	-	-	-	-	-	-	-	-	-	-
20	T	8999	1229	615	410	307	246	205	175	153	136	123	111	102	94	87	82	76
	S	-	2107	1053	702	527	421	351	301	263	234	211	192	176	162	150	140	132
40	T	8999	2451	1229	820	615	492	410	351	307	273	246	223	205	189	175	164	153
	S	-	4214	2107	1405	1053	843	702	602	527	468	421	383	351	324	301	281	263
60	T	8999	3657	1841	1229	922	738	615	527	461	410	369	335	307	284	263	246	230
	S	-	6321	3160	2107	1580	1264	1053	903	790	702	632	575	527	486	451	421	395
80	T	8999	4840	2451	1638	1229	984	820	703	615	546	492	447	410	378	351	328	307
	S	-	8428	4214	2809	2107	1686	1405	1204	1053	936	843	766	702	648	602	562	527
100	T	8999	5994	3056	2045	1536	1229	1025	878	769	683	615	559	512	473	439	410	384
	S	-	10535	5267	3512	2634	2107	1756	1505	1317	1171	1053	958	878	810	752	702	658
120	T	8999	7113	3657	2451	1841	1474	1229	1054	922	820	738	671	615	567	527	492	461
	S	-	12641	6321	4214	3160	2528	2107	1806	1580	1405	1264	1149	1053	972	903	843	790
140	T	8999	8193	4252	2855	2147	1719	1433	1229	1076	956	861	782	717	662	615	574	538
	S	-	14748	7374	4916	3687	2950	2458	2107	1844	1639	1475	1341	1229	1134	1053	983	922
160	T	8999	8936	4840	3257	2451	1964	1638	1404	1229	1093	984	894	820	757	703	656	615
	S	-	16855	8428	5618	4214	3371	2809	2408	2107	1873	1686	1532	1405	1297	1204	1124	1053
180	T	8999	8950	5421	3657	2754	2207	1841	1579	1382	1229	1106	1006	922	851	790	738	692
	S	-	18962	9481	6321	4741	3792	3160	2709	2370	2107	1896	1724	1580	1459	1354	1264	1185
200	T	8999	8959	5994	4054	3056	2451	2045	1754	1536	1365	1229	1118	1025	946	878	820	769
	S	-	21069	10535	7023	5267	4214	3512	3010	2634	2341	2107	1915	1756	1621	1505	1405	1317
220	T	8999	8966	6558	4449	3357	2693	2248	1929	1689	1502	1352	1229	1127	1040	966	902	845
	S	-	23176	11588	7725	5794	4635	3863	3311	2897	2575	2318	2107	1931	1783	1655	1545	1448
240	T	8999	8971	7113	4840	3657	2935	2451	2103	1841	1638	1474	1341	1229	1135	1054	984	922
	S	-	25283	12641	8428	6321	5057	4214	3612	3160	2809	2528	2298	2107	1945	1806	1686	1580

TTM: Timber-Timber-Maximum | TTP: Timber-Timber-Partial | TCM: Timber-Concrete-Maximum | TCP: Timber-Concrete-Partial

T: $F_{T,Rk}$ load-carrying capacity of timber | S: $F_{S,Rk}$ load-carrying capacity of steel

Table B. 11 Angle bracket type 5501S, Variant TTM, Fastener GH Nail 4x60, Density 350 kg/m³Characteristic load-carrying capacity $F_{1,Rk}$ (N) for one / two angle brackets

angle bracket		1													2
f (mm)		0	10	20	30	40	50	60	70	80	90	100	110	120	0
$F_{1,Rk}$	T	2051	1341	673	449	337	269	224	192	168	149	134	122	112	4102
	S	2107	1541	770	514	385	308	257	220	193	171	154	140	128	4214

Characteristic load-carrying capacity $F_{2/3,Rk}$ (N) for one / two angle brackets

angle bracket		1	2
$F_{2/3,Rk}$	T	4850	9700
	S	-	-

Characteristic load-carrying capacity $F_{4,Rk}$ (N) for one angle bracket

e (mm)		0	20	40	60	80	100	120	140	160	180	200	220	240	260	280	300	320
$F_{4,Rk}$	T	16548	3794	1935	613	321	217	164	132	110	95	83	74	66	60	55	51	47
	S	-	4003	2002	700	367	249	188	151	126	109	95	85	76	69	64	59	55

Characteristic load-carrying capacity $F_{5,Rk}$ (N) for one angle bracket

b / e (mm)		0	20	40	60	80	100	120	140	160	180	200	220	240	260	280	300	320
0	T	355	749	2512	1675	1256	1005	837	717	628	558	502	456	418	386	358	334	314
	S	405	856	2868	1912	1434	1147	956	819	717	637	574	521	478	441	410	382	358
20	T	355	749	2312	1541	1156	924	770	660	578	513	462	420	385	355	330	308	289
	S	405	856	2868	1912	1434	1147	956	819	717	637	574	521	478	441	410	382	358
40	T	355	749	2457	1638	1228	983	819	702	614	546	491	446	409	378	351	327	307
	S	405	856	2868	1912	1434	1147	956	819	717	637	574	521	478	441	410	382	358
60	T	355	749	2487	1658	1243	995	829	710	621	552	497	452	414	382	355	331	310
	S	405	856	2868	1912	1434	1147	956	819	717	637	574	521	478	441	410	382	358
80	T	355	749	2498	1665	1249	999	832	713	624	555	499	454	416	384	356	333	312
	S	405	856	2868	1912	1434	1147	956	819	717	637	574	521	478	441	410	382	358
100	T	355	749	2503	1668	1251	1001	834	715	625	556	500	455	417	385	357	333	312
	S	405	856	2868	1912	1434	1147	956	819	717	637	574	521	478	441	410	382	358
120	T	355	749	2506	1670	1253	1002	835	716	626	556	501	455	417	385	358	334	313
	S	405	856	2868	1912	1434	1147	956	819	717	637	574	521	478	441	410	382	358
140	T	355	749	2507	1671	1253	1003	835	716	626	557	501	455	417	385	358	334	313
	S	405	856	2868	1912	1434	1147	956	819	717	637	574	521	478	441	410	382	358
160	T	355	749	2508	1672	1254	1003	836	716	627	557	501	456	418	385	358	334	313
	S	405	856	2868	1912	1434	1147	956	819	717	637	574	521	478	441	410	382	358
180	T	355	749	2509	1673	1254	1003	836	717	627	557	501	456	418	386	358	334	313
	S	405	856	2868	1912	1434	1147	956	819	717	637	574	521	478	441	410	382	358
200	T	355	749	2510	1673	1255	1004	836	717	627	557	502	456	418	386	358	334	313
	S	405	856	2868	1912	1434	1147	956	819	717	637	574	521	478	441	410	382	358
220	T	355	749	2510	1673	1255	1004	836	717	627	557	502	456	418	386	358	334	313
	S	405	856	2868	1912	1434	1147	956	819	717	637	574	521	478	441	410	382	358
240	T	355	749	2510	1673	1255	1004	836	717	627	557	502	456	418	386	358	334	313
	S	405	856	2868	1912	1434	1147	956	819	717	637	574	521	478	441	410	382	358

Characteristic load-carrying capacity $F_{4/5,Rk}$ (N) for two angle brackets

b / e (mm)		0	20	40	60	80	100	120	140	160	180	200	220	240	260	280	300	320
0	T	15000	15000	15000	15000	15000	15000	15000	15000	15000	15000	15000	15000	15000	15000	15000	15000	15000
	S	-	-	-	-	-	-	-	-	-	-	-	-	-	-	-	-	-
20	T	15000	2047	1025	683	512	410	341	293	256	227	205	186	170	157	146	136	128
	S	-	2107	1053	702	527	421	351	301	263	234	211	192	176	162	150	140	132
40	T	15000	4071	2047	1366	1025	820	683	586	512	455	410	372	341	315	293	273	256
	S	-	4214	2107	1405	1053	843	702	602	527	468	421	383	351	324	301	281	263
60	T	15000	6050	3064	2047	1537	1230	1025	878	769	683	615	559	512	473	439	410	384
	S	-	6321	3160	2107	1580	1264	1053	903	790	702	632	575	527	486	451	421	395
80	T	15000	7965	4071	2726	2047	1639	1366	1171	1025	911	820	745	683	631	586	547	512
	S	-	8428	4214	2809	2107	1686	1405	1204	1053	936	843	766	702	648	602	562	527
100	T	15000	9797	5068	3401	2556	2047	1707	1463	1281	1139	1025	932	854	788	732	683	640
	S	-	10535	5267	3512	2634	2107	1756	1505	1317	1171	1053	958	878	810	752	702	658
120	T	15000	11537	6050	4071	3064	2455	2047	1755	1537	1366	1230	1118	1025	946	878	820	769
	S	-	12641	6321	4214	3160	2528	2107	1806	1580	1405	1264	1149	1053	972	903	843	790
140	T	15000	13174	7017	4737	3569	2861	2387	2047	1792	1593	1434	1304	1195	1104	1025	956	897
	S	-	14748	7374	4916	3687	2950	2458	2107	1844	1639	1475	1341	1229	1134	1053	983	922
160	T	15000	14703	7965	5397	4071	3266	2726	2338	2047	1820	1639	1490	1366	1261	1171	1093	1025
	S	-	16855	8428	5618	4214	3371	2809	2408	2107	1873	1686	1532	1405	1297	1204	1124	1053
180	T	15000	14853	8892	6050	4571	3670	3064	2629	2302	2047	1843	1676	1537	1419	1317	1230	1153
	S	-	18962	9481	6321	4741	3792	3160	2709	2370	2107	1896	1724	1580	1459	1354	1264	1185
200	T	15000	14880	9797	6697	5068	4071	3401	2919	2556	2274	2047	1862	1707	1576	1463	1366	1281
	S	-	21069	10535	7023	5267	4214	3512	3010	2634	2341	2107	1915	1756	1621	1505	1405	1317
220	T	15000	14901	10679	7335	5561	4472	3737	3208	2810	2500	2251	2047	1877	1733	1610	1502	1409
	S	-	23176	11588	7725	5794	4635	3863	3311	2897	2575	2318	2107	1931	1783	1655	1545	1448
240	T	15000	14916	11537	7965	6050	4870	4071	3497	3064	2726	2455	2232	2047	1890	1755	1639	1537
	S	-	25283	12641	8428	6321	5057	4214	3612	3160	2809	2528	2298	2107	1945	1806	1686	1580

TTM: Timber-Timber-Maximum | TTP: Timber-Timber-Partial | TCM: Timber-Concrete-Maximum | TCP: Timber-Concrete-Partial

T: $F_{1,T,Rk}$ load-carrying capacity of timber | S: $F_{1,S,Rk}$ load-carrying capacity of steel

Table B. 12 Angle bracket type 5501S, Variant TTM, Fastener GH Screw 5x40, Density 350 kg/m³Characteristic load-carrying capacity $F_{1,Rk}$ (N) for one / two angle brackets

angle bracket		1													2
f (mm)		0	10	20	30	40	50	60	70	80	90	100	110	120	0
$F_{1,Rk}$	T	2585	1701	850	567	425	340	284	243	213	189	170	155	142	5170
	S	2106	1540	770	513	385	308	256	220	192	171	154	140	128	4212

Characteristic load-carrying capacity $F_{2/3,Rk}$ (N) for one / two angle brackets

angle bracket		1	2
$F_{2/3,Rk}$	T	4410	8820
	S	-	-

Characteristic load-carrying capacity $F_{4,Rk}$ (N) for one angle bracket

e (mm)		0	20	40	60	80	100	120	140	160	180	200	220	240	260	280	300	320
$F_{4,Rk}$	T	14021	4911	2456	773	405	274	207	167	139	120	105	93	84	77	70	65	60
	S	-	4003	2001	700	366	248	187	151	126	108	95	84	76	69	63	58	54

Characteristic load-carrying capacity $F_{5,Rk}$ (N) for one angle bracket

b / e (mm)		0	20	40	60	80	100	120	140	160	180	200	220	240	260	280	300	320
0	T	448	945	3166	2111	1583	1266	1055	905	791	704	633	576	528	487	452	422	396
	S	405	856	2867	1911	1433	1147	955	819	716	637	573	521	477	441	409	382	358
20	T	448	945	2675	1783	1337	1070	891	764	668	594	535	486	445	411	382	356	334
	S	405	856	2868	1912	1434	1147	956	819	717	637	574	521	478	441	410	382	358
40	T	448	945	3166	2111	1583	1266	1055	905	791	704	633	576	528	487	452	422	396
	S	405	856	2867	1911	1433	1147	955	819	716	637	573	521	477	441	409	382	358
60	T	448	945	3166	2111	1583	1266	1055	905	791	704	633	576	528	487	452	422	396
	S	405	856	2867	1911	1433	1147	955	819	716	637	573	521	477	441	409	382	358
80	T	448	945	3166	2111	1583	1266	1055	905	791	704	633	576	528	487	452	422	396
	S	405	856	2867	1911	1433	1147	955	819	716	637	573	521	477	441	409	382	358
100	T	448	945	3166	2111	1583	1266	1055	905	791	704	633	576	528	487	452	422	396
	S	405	856	2867	1911	1433	1147	955	819	716	637	573	521	477	441	409	382	358
120	T	448	945	3166	2111	1583	1266	1055	905	791	704	633	576	528	487	452	422	396
	S	405	856	2867	1911	1433	1147	955	819	716	637	573	521	477	441	409	382	358
140	T	448	945	3166	2111	1583	1266	1055	905	791	704	633	576	528	487	452	422	396
	S	405	856	2867	1911	1433	1147	955	819	716	637	573	521	477	441	409	382	358
160	T	448	945	3166	2111	1583	1266	1055	905	791	704	633	576	528	487	452	422	396
	S	405	856	2867	1911	1433	1147	955	819	716	637	573	521	477	441	409	382	358
180	T	448	945	3166	2111	1583	1266	1055	905	791	704	633	576	528	487	452	422	396
	S	405	856	2867	1911	1433	1147	955	819	716	637	573	521	477	441	409	382	358
200	T	448	945	3166	2111	1583	1266	1055	905	791	704	633	576	528	487	452	422	396
	S	405	856	2867	1911	1433	1147	955	819	716	637	573	521	477	441	409	382	358
220	T	448	945	3166	2111	1583	1266	1055	905	791	704	633	576	528	487	452	422	396
	S	405	856	2867	1911	1433	1147	955	819	716	637	573	521	477	441	409	382	358
240	T	448	945	3166	2111	1583	1266	1055	905	791	704	633	576	528	487	452	422	396
	S	405	856	2867	1911	1433	1147	955	819	716	637	573	521	477	441	409	382	358

Characteristic load-carrying capacity $F_{4/5,Rk}$ (N) for two angle brackets

b / e (mm)		0	20	40	60	80	100	120	140	160	180	200	220	240	260	280	300	320
0	T	18899	18899	18899	18899	18899	18899	18899	18899	18899	18899	18899	18899	18899	18899	18899	18899	18899
	S	-	-	-	-	-	-	-	-	-	-	-	-	-	-	-	-	-
20	T	18899	2585	1292	862	646	517	431	369	323	287	258	235	215	199	185	172	162
	S	-	2106	1053	702	526	421	351	300	263	234	210	191	175	162	150	140	131
40	T	18899	5170	2585	1723	1292	1034	862	739	646	574	517	470	431	398	369	345	323
	S	-	4213	2106	1404	1053	842	702	601	526	468	421	383	351	324	300	280	263
60	T	18899	7755	3877	2585	1939	1551	1292	1108	969	862	775	705	646	597	554	517	485
	S	-	6320	3160	2106	1580	1264	1053	902	790	702	632	574	526	486	451	421	395
80	T	18899	10340	5170	3447	2585	2068	1723	1477	1292	1149	1034	940	862	795	739	689	646
	S	-	8427	4213	2809	2106	1685	1404	1203	1053	936	842	766	702	648	601	561	526
100	T	18899	12925	6462	4308	3231	2585	2154	1846	1616	1436	1292	1175	1077	994	923	862	808
	S	-	10534	5267	3511	2633	2106	1755	1504	1316	1170	1053	957	877	810	752	702	658
120	T	18899	14572	7755	5170	3877	3102	2585	2216	1939	1723	1551	1410	1292	1193	1108	1034	969
	S	-	12641	6320	4213	3160	2528	2106	1805	1580	1404	1264	1149	1053	972	902	842	790
140	T	18899	15674	9047	6032	4524	3619	3016	2585	2262	2011	1809	1645	1508	1392	1292	1206	1131
	S	-	14748	7374	4916	3687	2949	2458	2106	1843	1638	1474	1340	1229	1134	1053	983	921
160	T	18899	16643	10340	6893	5170	4136	3447	2954	2585	2298	2068	1880	1723	1591	1477	1379	1292
	S	-	16855	8427	5618	4213	3371	2809	2407	2106	1872	1685	1532	1404	1296	1203	1123	1053
180	T	18899	17904	11632	7755	5816	4653	3877	3324	2908	2585	2326	2115	1939	1790	1662	1551	1454
	S	-	18962	9481	6320	4740	3792	3160	2708	2370	2106	1896	1723	1580	1458	1354	1264	1185
200	T	18899	18572	12925	8617	6462	5170	4308	3693	3231	2872	2585	2350	2154	1988	1846	1723	1616
	S	-	21069	10534	7023	5267	4213	3511	3009	2633	2341	2106	1915	1755	1620	1504	1404	1316
220	T	18899	18627	13877	9478	7109	5687	4739	4062	3554	3159	2843	2585	2370	2187	2031	1896	1777
	S	-	23176	11587	7725	5793	4635	3862	3310	2896	2575	2317	2106	1931	1782	1655	1545	1448
240	T	18899	18670	14572	10340	7755	6204	5170	4431	3877	3447	3102	2820	2585	2386	2216	2068	1939
	S	-	25283	12641	8427	6320	5056	4213	3611	3160	2809	2528	2298	2106	1944	1805	1685	1580

TTM: Timber-Timber-Maximum | TTP: Timber-Timber-Partial | TCM: Timber-Concrete-Maximum | TCP: Timber-Concrete-Partial

T: $F_{1,T,Rk}$ load-carrying capacity of timber | S: $F_{1,S,Rk}$ load-carrying capacity of steel

Table B. 13 Angle bracket type 5501S, Variant TTM, Fastener GH Screw 5x60, Density 350 kg/m³Characteristic load-carrying capacity $F_{1,Rk}$ (N) for one / two angle brackets

angle bracket		1													2
f (mm)		0	10	20	30	40	50	60	70	80	90	100	110	120	0
$F_{1,Rk}$	T	4021	2646	1323	882	662	529	441	378	331	294	265	241	221	8042
	S	2106	1540	770	513	385	308	256	220	192	171	154	140	128	4212

Characteristic load-carrying capacity $F_{2/3,Rk}$ (N) for one / two angle brackets

angle bracket		1	2
$F_{2/3,Rk}$	T	5210	10420
	S	-	-

Characteristic load-carrying capacity $F_{4,Rk}$ (N) for one angle bracket

e (mm)		0	20	40	60	80	100	120	140	160	180	200	220	240	260	280	300	320
$F_{4,Rk}$	T	15855	7640	3820	1203	630	427	323	259	217	186	163	145	131	119	109	101	94
	S	-	4003	2001	700	366	248	187	151	126	108	95	84	76	69	63	58	54

Characteristic load-carrying capacity $F_{5,Rk}$ (N) for one angle bracket

b / e (mm)		0	20	40	60	80	100	120	140	160	180	200	220	240	260	280	300	320
0	T	696	1470	4925	3283	2462	1970	1642	1407	1231	1094	985	895	821	758	704	657	616
	S	405	856	2867	1911	1433	1147	955	819	716	637	573	521	477	441	409	382	358
20	T	696	1470	4816	3211	2409	1926	1606	1376	1205	1070	964	876	804	741	689	643	603
	S	405	856	2867	1911	1433	1147	955	819	716	637	573	521	477	441	409	382	358
40	T	696	1470	4925	3283	2462	1970	1642	1407	1231	1094	985	895	821	758	704	657	616
	S	405	856	2867	1911	1433	1147	955	819	716	637	573	521	477	441	409	382	358
60	T	696	1470	4925	3283	2462	1970	1642	1407	1231	1094	985	895	821	758	704	657	616
	S	405	856	2867	1911	1433	1147	955	819	716	637	573	521	477	441	409	382	358
80	T	696	1470	4925	3283	2462	1970	1642	1407	1231	1094	985	895	821	758	704	657	616
	S	405	856	2867	1911	1433	1147	955	819	716	637	573	521	477	441	409	382	358
100	T	696	1470	4925	3283	2462	1970	1642	1407	1231	1094	985	895	821	758	704	657	616
	S	405	856	2867	1911	1433	1147	955	819	716	637	573	521	477	441	409	382	358
120	T	696	1470	4925	3283	2462	1970	1642	1407	1231	1094	985	895	821	758	704	657	616
	S	405	856	2867	1911	1433	1147	955	819	716	637	573	521	477	441	409	382	358
140	T	696	1470	4925	3283	2462	1970	1642	1407	1231	1094	985	895	821	758	704	657	616
	S	405	856	2867	1911	1433	1147	955	819	716	637	573	521	477	441	409	382	358
160	T	696	1470	4925	3283	2462	1970	1642	1407	1231	1094	985	895	821	758	704	657	616
	S	405	856	2867	1911	1433	1147	955	819	716	637	573	521	477	441	409	382	358
180	T	696	1470	4925	3283	2462	1970	1642	1407	1231	1094	985	895	821	758	704	657	616
	S	405	856	2867	1911	1433	1147	955	819	716	637	573	521	477	441	409	382	358
200	T	696	1470	4925	3283	2462	1970	1642	1407	1231	1094	985	895	821	758	704	657	616
	S	405	856	2867	1911	1433	1147	955	819	716	637	573	521	477	441	409	382	358
220	T	696	1470	4925	3283	2462	1970	1642	1407	1231	1094	985	895	821	758	704	657	616
	S	405	856	2867	1911	1433	1147	955	819	716	637	573	521	477	441	409	382	358
240	T	696	1470	4925	3283	2462	1970	1642	1407	1231	1094	985	895	821	758	704	657	616
	S	405	856	2867	1911	1433	1147	955	819	716	637	573	521	477	441	409	382	358

Characteristic load-carrying capacity $F_{4/5,Rk}$ (N) for two angle brackets

b / e (mm)		0	20	40	60	80	100	120	140	160	180	200	220	240	260	280	300	320
0	T	29399	29399	29399	29399	29399	29399	29399	29399	29399	29399	29399	29399	29399	29399	29399	29399	29399
	S	-	-	-	-	-	-	-	-	-	-	-	-	-	-	-	-	-
20	T	29399	4021	2011	1340	1005	804	670	574	503	447	402	366	335	309	287	268	251
	S	-	2106	1053	702	526	421	351	300	263	234	210	191	175	162	150	140	131
40	T	29399	8042	4021	2681	2011	1608	1340	1149	1005	894	804	731	670	619	574	536	503
	S	-	4213	2106	1404	1053	842	702	601	526	468	421	383	351	324	300	280	263
60	T	29399	12063	6032	4021	3016	2413	2011	1723	1508	1340	1206	1097	1005	928	862	804	754
	S	-	6320	3160	2106	1580	1264	1053	902	790	702	632	574	526	486	451	421	395
80	T	29399	16084	8042	5361	4021	3217	2681	2298	2011	1787	1608	1462	1340	1237	1149	1072	1005
	S	-	8427	4213	2809	2106	1685	1404	1203	1053	936	842	766	702	648	601	561	526
100	T	29399	20105	10053	6702	5026	4021	3351	2872	2513	2234	2011	1828	1675	1547	1436	1340	1257
	S	-	10534	5267	3511	2633	2106	1755	1504	1316	1170	1053	957	877	810	752	702	658
120	T	29399	24126	12063	8042	6032	4825	4021	3447	3016	2681	2413	2193	2011	1856	1723	1608	1508
	S	-	12641	6320	4213	3160	2528	2106	1805	1580	1404	1264	1149	1053	972	902	842	790
140	T	29399	28147	14074	9382	7037	5629	4691	4021	3518	3127	2815	2559	2346	2165	2011	1876	1759
	S	-	14748	7374	4916	3687	2949	2458	2106	1843	1638	1474	1340	1229	1134	1053	983	921
160	T	29399	29400	16084	10723	8042	6434	5361	4595	4021	3574	3217	2924	2681	2474	2298	2145	2011
	S	-	16855	8427	5618	4213	3371	2809	2407	2106	1872	1685	1532	1404	1296	1203	1123	1053
180	T	29399	29400	18095	12063	9047	7238	6032	5170	4524	4021	3619	3290	3016	2784	2585	2413	2262
	S	-	18962	9481	6320	4740	3792	3160	2708	2370	2106	1896	1723	1580	1458	1354	1264	1185
200	T	29399	29400	20105	13403	10053	8042	6702	5744	5026	4468	4021	3655	3351	3093	2872	2681	2513
	S	-	21069	10534	7023	5267	4213	3511	3009	2633	2341	2106	1915	1755	1620	1504	1404	1316
220	T	29399	28659	22116	14744	11058	8846	7372	6319	5529	4915	4423	4021	3686	3402	3159	2949	2764
	S	-	23175	11587	7725	5793	4635	3862	3310	2896	2575	2317	2106	1931	1782	1655	1545	1448
240	T	29399	27777	24126	16084	12063	9651	8042	6893	6032	5361	4825	4387	4021	3712	3447	3217	3016
	S	-	25282	12641	8427	6320	5056	4213	3611	3160	2809	2528	2298	2106	1944	1805	1685	1580

TTM: Timber-Timber-Maximum | TTP: Timber-Timber-Partial | TCM: Timber-Concrete-Maximum | TCP: Timber-Concrete-Partial

T: $F_{1,T,Rk}$ load-carrying capacity of timber | S: $F_{1,S,Rk}$ load-carrying capacity of steel

Table B. 14 Angle bracket type 5501S, Variant TTP, Fastener GH Nail 4x40, Density 350 kg/m³Characteristic load-carrying capacity $F_{T,Rk}$ (N) for one / two angle brackets

angle bracket		1													2
f (mm)		0	10	20	30	40	50	60	70	80	90	100	110	120	0
$F_{T,Rk}$	T	1089	805	404	269	202	161	134	115	101	89	80	73	67	2178
	S	4629	1541	770	514	385	308	257	220	193	171	154	140	128	9257

Characteristic load-carrying capacity $F_{2/3,Rk}$ (N) for one / two angle brackets

angle bracket		1	2
$F_{2/3,Rk}$	T	3010	6020
	S	-	-

Characteristic load-carrying capacity $F_{4,Rk}$ (N) for one angle bracket

e (mm)		0	20	40	60	80	100	120	140	160	180	200	220	240	260	280	300	320
$F_{4,Rk}$	T	7559	1996	1025	368	192	130	98	79	66	57	49	44	40	36	33	30	28
	S	-	5735	2868	700	367	249	188	151	126	109	95	85	76	69	64	59	55

Characteristic load-carrying capacity $F_{5,Rk}$ (N) for one angle bracket

b / e (mm)		0	20	40	60	80	100	120	140	160	180	200	220	240	260	280	300	320
0	T	213	449	672	449	337	269	224	192	168	149	134	122	112	103	96	89	84
	S	405	856	2868	1912	1434	1147	956	819	717	637	574	521	478	441	410	382	358
20	T	213	449	1400	933	700	560	466	400	350	311	280	254	233	215	200	186	175
	S	405	856	2868	1912	1434	1147	956	819	717	637	574	521	478	441	410	382	358
40	T	213	449	1478	985	739	591	492	422	369	328	295	268	246	227	211	197	184
	S	405	856	2868	1912	1434	1147	956	819	717	637	574	521	478	441	410	382	358
60	T	213	449	1494	996	747	597	498	426	373	332	298	271	249	229	213	199	186
	S	405	856	2868	1912	1434	1147	956	819	717	637	574	521	478	441	410	382	358
80	T	213	449	1500	1000	750	600	500	428	375	333	300	272	250	230	214	200	187
	S	405	856	2868	1912	1434	1147	956	819	717	637	574	521	478	441	410	382	358
100	T	213	449	1502	1001	751	601	500	429	375	333	300	273	250	231	214	200	187
	S	405	856	2868	1912	1434	1147	956	819	717	637	574	521	478	441	410	382	358
120	T	213	449	1504	1002	752	601	501	429	376	334	300	273	250	231	214	200	188
	S	405	856	2868	1912	1434	1147	956	819	717	637	574	521	478	441	410	382	358
140	T	213	449	1505	1003	752	602	501	430	376	334	301	273	250	231	215	200	188
	S	405	856	2868	1912	1434	1147	956	819	717	637	574	521	478	441	410	382	358
160	T	213	449	1505	1003	752	602	501	430	376	334	301	273	250	231	215	200	188
	S	405	856	2868	1912	1434	1147	956	819	717	637	574	521	478	441	410	382	358
180	T	213	449	1506	1004	753	602	502	430	376	334	301	273	251	231	215	200	188
	S	405	856	2868	1912	1434	1147	956	819	717	637	574	521	478	441	410	382	358
200	T	213	449	1506	1004	753	602	502	430	376	334	301	273	251	231	215	200	188
	S	405	856	2868	1912	1434	1147	956	819	717	637	574	521	478	441	410	382	358
220	T	213	449	1506	1004	753	602	502	430	376	334	301	273	251	231	215	200	188
	S	405	856	2868	1912	1434	1147	956	819	717	637	574	521	478	441	410	382	358
240	T	213	449	1506	1004	753	602	502	430	376	334	301	273	251	231	215	200	188
	S	405	856	2868	1912	1434	1147	956	819	717	637	574	521	478	441	410	382	358

Characteristic load-carrying capacity $F_{4/5,Rk}$ (N) for two angle brackets

b / e (mm)		0	20	40	60	80	100	120	140	160	180	200	220	240	260	280	300	320
0	T	7199	7199	7199	7199	7199	7199	7199	7199	7199	7199	7199	7199	7199	7199	7199	7199	7199
	S	-	-	-	-	-	-	-	-	-	-	-	-	-	-	-	-	-
20	T	7199	1086	544	363	272	217	181	155	136	121	108	99	90	83	77	72	68
	S	-	4629	2314	1543	1157	926	771	661	579	514	463	421	386	356	331	309	289
40	T	7199	2156	1086	725	544	435	363	311	272	242	217	198	181	167	155	145	136
	S	-	9257	4629	3086	2314	1851	1543	1322	1157	1029	926	842	771	712	661	617	579
60	T	7199	3194	1624	1086	815	653	544	466	408	363	326	297	272	251	233	217	204
	S	-	13886	6943	4629	3471	2777	2314	1984	1736	1543	1389	1262	1157	1068	992	926	868
80	T	7199	4187	2156	1445	1086	870	725	622	544	483	435	396	363	335	311	290	272
	S	-	18514	9257	6171	4629	3703	3086	2645	2314	2057	1851	1683	1543	1424	1322	1234	1157
100	T	7199	5124	2680	1802	1356	1086	906	777	680	604	544	494	453	418	388	363	340
	S	-	23143	11572	7714	5786	4629	3857	3306	2893	2571	2314	2104	1929	1780	1653	1543	1446
120	T	7199	6000	3194	2156	1624	1302	1086	932	815	725	653	593	544	502	466	435	408
	S	-	27772	13886	9257	6943	5554	4629	3967	3471	3086	2777	2525	2314	2136	1984	1851	1736
140	T	7199	6809	3697	2506	1891	1517	1266	1086	951	846	761	692	634	586	544	508	476
	S	-	32400	16200	10800	8100	6480	5400	4629	4050	3600	3240	2945	2700	2492	2314	2160	2025
160	T	7199	7149	4187	2853	2156	1731	1445	1240	1086	966	870	791	725	669	622	580	544
	S	-	37029	18514	12343	9257	7406	6171	5290	4629	4114	3703	3366	3086	2848	2645	2469	2314
180	T	7199	7160	4663	3194	2419	1944	1624	1394	1221	1086	978	889	815	753	699	653	612
	S	-	41657	20829	13886	10414	8331	6943	5951	5207	4629	4166	3787	3471	3204	2976	2777	2604
200	T	7199	7167	5124	3531	2680	2156	1802	1548	1356	1206	1086	988	906	836	777	725	680
	S	-	46286	23143	15429	11572	9257	7714	6612	5786	5143	4629	4208	3857	3560	3306	3086	2893
220	T	7199	7173	5570	3862	2938	2367	1980	1701	1490	1326	1194	1086	996	920	854	797	748
	S	-	50915	25457	16972	12729	10183	8486	7274	6364	5657	5091	4629	4243	3917	3637	3394	3182
240	T	7199	7177	6000	4187	3194	2576	2156	1853	1624	1445	1302	1184	1086	1003	932	870	815
	S	-	55543	27772	18514	13886	11109	9257	7935	6943	6171	5554	5049	4629	4273	3967	3703	3471

TTM: Timber-Timber-Maximum | TTP: Timber-Timber-Partial | TCM: Timber-Concrete-Maximum | TCP: Timber-Concrete-Partial

T: $F_{T,Rk}$ load-carrying capacity of timber | S: $F_{S,Rk}$ load-carrying capacity of steel

Table B. 15 Angle bracket type 5501S, Variant TTP, Fastener GH Nail 4x60, Density 350 kg/m³Characteristic load-carrying capacity $F_{1,Rk}$ (N) for one / two angle brackets

angle bracket		1													2
f (mm)		0	10	20	30	40	50	60	70	80	90	100	110	120	0
$F_{1,Rk}$	T	1815	1336	673	449	337	269	224	192	168	149	134	122	112	3630
	S	4629	1541	770	514	385	308	257	220	193	171	154	140	128	9257

Characteristic load-carrying capacity $F_{2/3,Rk}$ (N) for one / two angle brackets

angle bracket		1	2
$F_{2/3,Rk}$	T	3910	7820
	S	-	-

Characteristic load-carrying capacity $F_{4,Rk}$ (N) for one angle bracket

e (mm)		0	20	40	60	80	100	120	140	160	180	200	220	240	260	280	300	320
$F_{4,Rk}$	T	9455	3241	1696	613	321	217	164	132	110	95	83	74	66	60	55	51	47
	S	-	5735	2868	700	367	249	188	151	126	109	95	85	76	69	64	59	55

Characteristic load-carrying capacity $F_{5,Rk}$ (N) for one angle bracket

b / e (mm)		0	20	40	60	80	100	120	140	160	180	200	220	240	260	280	300	320
0	T	355	749	1117	747	561	449	374	321	281	249	224	204	187	173	160	149	140
	S	405	856	2868	1912	1434	1147	956	819	717	637	574	521	478	441	410	382	358
20	T	355	749	2218	1479	1109	887	739	633	554	493	443	403	369	341	316	295	277
	S	405	856	2868	1912	1434	1147	956	819	717	637	574	521	478	441	410	382	358
40	T	355	749	2428	1618	1214	971	809	693	607	539	485	441	404	373	346	323	303
	S	405	856	2868	1912	1434	1147	956	819	717	637	574	521	478	441	410	382	358
60	T	355	749	2473	1649	1236	989	824	706	618	549	494	449	412	380	353	329	309
	S	405	856	2868	1912	1434	1147	956	819	717	637	574	521	478	441	410	382	358
80	T	355	749	2490	1660	1245	996	830	711	622	553	498	452	415	383	355	332	311
	S	405	856	2868	1912	1434	1147	956	819	717	637	574	521	478	441	410	382	358
100	T	355	749	2498	1665	1249	999	832	713	624	555	499	454	416	384	356	333	312
	S	405	856	2868	1912	1434	1147	956	819	717	637	574	521	478	441	410	382	358
120	T	355	749	2502	1668	1251	1001	834	715	625	556	500	455	417	385	357	333	312
	S	405	856	2868	1912	1434	1147	956	819	717	637	574	521	478	441	410	382	358
140	T	355	749	2505	1670	1252	1002	835	715	626	556	501	455	417	385	357	334	313
	S	405	856	2868	1912	1434	1147	956	819	717	637	574	521	478	441	410	382	358
160	T	355	749	2506	1671	1253	1002	835	716	626	557	501	455	417	385	358	334	313
	S	405	856	2868	1912	1434	1147	956	819	717	637	574	521	478	441	410	382	358
180	T	355	749	2508	1672	1254	1003	836	716	627	557	501	456	418	385	358	334	313
	S	405	856	2868	1912	1434	1147	956	819	717	637	574	521	478	441	410	382	358
200	T	355	749	2508	1672	1254	1003	836	716	627	557	501	456	418	385	358	334	313
	S	405	856	2868	1912	1434	1147	956	819	717	637	574	521	478	441	410	382	358
220	T	355	749	2509	1673	1254	1003	836	717	627	557	501	456	418	386	358	334	313
	S	405	856	2868	1912	1434	1147	956	819	717	637	574	521	478	441	410	382	358
240	T	355	749	2510	1673	1255	1004	836	717	627	557	502	456	418	386	358	334	313
	S	405	856	2868	1912	1434	1147	956	819	717	637	574	521	478	441	410	382	358

Characteristic load-carrying capacity $F_{4/5,Rk}$ (N) for two angle brackets

b / e (mm)		0	20	40	60	80	100	120	140	160	180	200	220	240	260	280	300	320
0	T	12000	12000	12000	12000	12000	12000	12000	12000	12000	12000	12000	12000	12000	12000	12000	12000	12000
	S	-	-	-	-	-	-	-	-	-	-	-	-	-	-	-	-	-
20	T	12000	1807	906	604	453	363	302	259	226	201	181	165	151	139	129	121	113
	S	-	4629	2314	1543	1157	926	771	661	579	514	463	421	386	356	331	309	289
40	T	12000	3566	1807	1208	906	725	604	518	453	403	363	330	302	279	259	242	226
	S	-	9257	4629	3086	2314	1851	1543	1322	1157	1029	926	842	771	712	661	617	579
60	T	12000	5234	2695	1807	1358	1087	906	777	680	604	544	495	453	418	389	363	340
	S	-	13886	6943	4629	3471	2777	2314	1984	1736	1543	1389	1262	1157	1068	992	926	868
80	T	12000	6780	3566	2401	1807	1448	1208	1036	906	806	725	659	604	558	518	484	453
	S	-	18514	9257	6171	4629	3703	3086	2645	2314	2057	1851	1683	1543	1424	1322	1234	1157
100	T	12000	8184	4414	2988	2253	1807	1508	1293	1132	1007	906	824	755	697	648	604	567
	S	-	23143	11572	7714	5786	4629	3857	3306	2893	2571	2314	2104	1929	1780	1653	1543	1446
120	T	12000	9440	5234	3566	2695	2164	1807	1551	1358	1208	1087	989	906	837	777	725	680
	S	-	27772	13886	9257	6943	5554	4629	3967	3471	3086	2777	2525	2314	2136	1984	1851	1736
140	T	12000	10549	6024	4134	3133	2519	2105	1807	1583	1408	1268	1153	1057	976	906	846	793
	S	-	32400	16200	10800	8100	6480	5400	4629	4050	3600	3240	2945	2700	2492	2314	2160	2025
160	T	12000	11520	6780	4690	3566	2871	2401	2062	1807	1608	1448	1317	1208	1115	1036	967	906
	S	-	37029	18514	12343	9257	7406	6171	5290	4629	4114	3703	3366	3086	2848	2645	2469	2314
180	T	12000	11882	7500	5234	3993	3220	2695	2316	2030	1807	1628	1481	1358	1254	1165	1087	1019
	S	-	41657	20829	13886	10414	8331	6943	5951	5207	4629	4166	3787	3471	3204	2976	2777	2604
200	T	12000	11904	8184	5764	4414	3566	2988	2569	2253	2006	1807	1644	1508	1392	1293	1208	1132
	S	-	46286	23143	15429	11572	9257	7714	6612	5786	5143	4629	4208	3857	3560	3306	3086	2893
220	T	12000	11920	8831	6280	4827	3908	3278	2821	2475	2204	1986	1807	1658	1531	1422	1328	1245
	S	-	50915	25457	16972	12729	10183	8486	7274	6364	5657	5091	4629	4243	3917	3637	3394	3182
240	T	12000	11933	9440	6780	5234	4246	3566	3071	2695	2401	2164	1970	1807	1669	1551	1448	1358
	S	-	55543	27772	18514	13886	11109	9257	7935	6943	6171	5554	5049	4629	4273	3967	3703	3471

TTM: Timber-Timber-Maximum | TTP: Timber-Timber-Partial | TCM: Timber-Concrete-Maximum | TCP: Timber-Concrete-Partial

T: $F_{T,Rk}$ load-carrying capacity of timber | S: $F_{S,Rk}$ load-carrying capacity of steel

Table B.16 Angle bracket type 5501S, Variant TTP, Fastener GH Screw 5x40, Density 350 kg/m³Characteristic load-carrying capacity $F_{T,Rk}$ (N) for one / two angle brackets

angle bracket		1													2
f (mm)		0	10	20	30	40	50	60	70	80	90	100	110	120	0
$F_{T,Rk}$	T	2287	1701	850	567	425	340	284	243	213	189	170	155	142	4574
	S	4629	1540	770	513	385	308	256	220	192	171	154	140	128	9257

Characteristic load-carrying capacity $F_{2/3,Rk}$ (N) for one / two angle brackets

angle bracket		1	2
$F_{2/3,Rk}$	T	3470	6940
	S	-	-

Characteristic load-carrying capacity $F_{4,Rk}$ (N) for one angle bracket

e (mm)		0	20	40	60	80	100	120	140	160	180	200	220	240	260	280	300	320
$F_{4,Rk}$	T	8011	3820	2097	773	405	274	207	167	139	120	105	93	84	77	70	65	60
	S	-	5735	2868	700	366	248	187	151	126	108	95	84	76	69	63	58	54

Characteristic load-carrying capacity $F_{5,Rk}$ (N) for one angle bracket

b / e (mm)		0	20	40	60	80	100	120	140	160	180	200	220	240	260	280	300	320
0	T	448	945	1395	938	705	565	471	404	354	314	283	257	236	217	202	188	177
	S	405	856	2868	1912	1434	1147	956	819	717	637	574	521	478	441	410	382	358
20	T	448	945	2483	1655	1241	993	827	709	620	551	496	451	413	382	354	331	310
	S	405	856	2868	1912	1434	1147	956	819	717	637	574	521	478	441	410	382	358
40	T	448	945	3024	2016	1512	1209	1009	864	757	672	605	550	505	465	433	403	378
	S	405	856	2867	1911	1433	1147	955	819	716	637	573	521	477	441	409	382	358
60	T	448	945	3166	2111	1583	1266	1055	905	791	704	633	576	528	487	452	422	396
	S	405	856	2867	1911	1433	1147	955	819	716	637	573	521	477	441	409	382	358
80	T	448	945	3166	2111	1583	1266	1055	905	791	704	633	576	528	487	452	422	396
	S	405	856	2867	1911	1433	1147	955	819	716	637	573	521	477	441	409	382	358
100	T	448	945	3166	2111	1583	1266	1055	905	791	704	633	576	528	487	452	422	396
	S	405	856	2867	1911	1433	1147	955	819	716	637	573	521	477	441	409	382	358
120	T	448	945	3166	2111	1583	1266	1055	905	791	704	633	576	528	487	452	422	396
	S	405	856	2867	1911	1433	1147	955	819	716	637	573	521	477	441	409	382	358
140	T	448	945	3166	2111	1583	1266	1055	905	791	704	633	576	528	487	452	422	396
	S	405	856	2867	1911	1433	1147	955	819	716	637	573	521	477	441	409	382	358
160	T	448	945	3166	2111	1583	1266	1055	905	791	704	633	576	528	487	452	422	396
	S	405	856	2867	1911	1433	1147	955	819	716	637	573	521	477	441	409	382	358
180	T	448	945	3166	2111	1583	1266	1055	905	791	704	633	576	528	487	452	422	396
	S	405	856	2867	1911	1433	1147	955	819	716	637	573	521	477	441	409	382	358
200	T	448	945	3166	2111	1583	1266	1055	905	791	704	633	576	528	487	452	422	396
	S	405	856	2867	1911	1433	1147	955	819	716	637	573	521	477	441	409	382	358
220	T	448	945	3166	2111	1583	1266	1055	905	791	704	633	576	528	487	452	422	396
	S	405	856	2867	1911	1433	1147	955	819	716	637	573	521	477	441	409	382	358
240	T	448	945	3166	2111	1583	1266	1055	905	791	704	633	576	528	487	452	422	396
	S	405	856	2867	1911	1433	1147	955	819	716	637	573	521	477	441	409	382	358

Characteristic load-carrying capacity $F_{4/5,Rk}$ (N) for two angle brackets

b / e (mm)		0	20	40	60	80	100	120	140	160	180	200	220	240	260	280	300	320
0	T	15120	15120	15120	15120	15120	15120	15120	15120	15120	15120	15120	15120	15120	15120	15120	15120	15120
	S	-	-	-	-	-	-	-	-	-	-	-	-	-	-	-	-	-
20	T	15120	2264	1141	761	571	457	381	326	285	254	228	207	190	175	163	152	142
	S	-	4629	2314	1543	1157	926	771	661	579	514	463	421	386	356	331	309	289
40	T	15120	4399	2264	1518	1141	913	761	653	571	508	457	415	381	351	326	304	285
	S	-	9257	4629	3086	2314	1851	1543	1322	1157	1029	926	842	771	712	661	617	579
60	T	15120	6309	3355	2264	1706	1367	1141	978	856	761	685	623	571	527	490	457	428
	S	-	13886	6943	4629	3471	2777	2314	1984	1736	1543	1389	1262	1157	1068	992	926	868
80	T	15120	7946	4399	2996	2264	1818	1518	1303	1141	1014	913	830	761	703	653	609	571
	S	-	18514	9257	6171	4629	3703	3086	2645	2314	2057	1851	1683	1543	1424	1322	1234	1157
100	T	15120	9310	5386	3709	2815	2264	1893	1625	1424	1267	1141	1037	951	878	816	761	714
	S	-	23143	11572	7714	5786	4629	3857	3306	2893	2571	2314	2104	1929	1780	1653	1543	1446
120	T	15120	10425	6309	4399	3355	2706	2264	1946	1706	1518	1367	1244	1141	1053	978	913	856
	S	-	27772	13886	9257	6943	5554	4629	3967	3471	3086	2777	2525	2314	2136	1984	1851	1736
140	T	15120	11327	7163	5064	3884	3140	2632	2264	1986	1768	1593	1449	1330	1228	1141	1065	999
	S	-	32400	16200	10800	8100	6480	5400	4629	4050	3600	3240	2945	2700	2492	2314	2160	2025
160	T	15120	12056	7946	5701	4399	3568	2996	2580	2264	2017	1818	1655	1518	1402	1303	1216	1141
	S	-	37029	18514	12343	9257	7406	6171	5290	4629	4114	3703	3366	3086	2848	2645	2469	2314
180	T	15120	12645	8661	6309	4901	3988	3355	2893	2541	2264	2042	1859	1706	1576	1464	1367	1282
	S	-	41657	20829	13886	10414	8331	6943	5951	5207	4629	4166	3787	3471	3204	2976	2777	2604
200	T	15120	13125	9310	6886	5386	4399	3709	3202	2815	2510	2264	2062	1893	1749	1625	1518	1424
	S	-	46286	23143	15429	11572	9257	7714	6612	5786	5143	4629	4208	3857	3560	3306	3086	2893
220	T	15120	13516	9896	7432	5856	4802	4057	3508	3086	2754	2486	2264	2079	1921	1786	1668	1565
	S	-	50915	25457	16972	12729	10183	8486	7274	6364	5657	5091	4629	4243	3917	3637	3394	3182
240	T	15120	13839	10425	7946	6309	5194	4399	3809	3355	2996	2706	2466	2264	2093	1946	1818	1706
	S	-	55543	27772	18514	13886	11109	9257	7935	6943	6171	5554	5049	4629	4273	3967	3703	3471

TTM: Timber-Timber-Maximum | TTP: Timber-Timber-Partial | TCM: Timber-Concrete-Maximum | TCP: Timber-Concrete-Partial

T: $F_{T,Rk}$ load-carrying capacity of timber | S: $F_{S,Rk}$ load-carrying capacity of steel

Table B.17 Angle bracket type 5501S, Variant TTP, Fastener GH Screw 5x60, Density 350 kg/m³Characteristic load-carrying capacity $F_{1,Rk}$ (N) for one / two angle brackets

angle bracket		1													2
f (mm)		0	10	20	30	40	50	60	70	80	90	100	110	120	0
$F_{1,Rk}$	T	3558	2646	1323	882	662	529	441	378	331	294	265	241	221	7116
	S	4629	1540	770	513	385	308	256	220	192	171	154	140	128	9257

Characteristic load-carrying capacity $F_{2/3,Rk}$ (N) for one / two angle brackets

angle bracket		1	2
$F_{2/3,Rk}$	T	4050	8100
	S	-	-

Characteristic load-carrying capacity $F_{4,Rk}$ (N) for one angle bracket

e (mm)		0	20	40	60	80	100	120	140	160	180	200	220	240	260	280	300	320
$F_{4,Rk}$	T	9059	5419	3381	1203	630	427	323	259	217	186	163	145	131	119	109	101	94
	S	-	5735	2867	700	366	248	187	151	126	108	95	84	76	69	63	58	54

Characteristic load-carrying capacity $F_{5,Rk}$ (N) for one angle bracket

b / e (mm)		0	20	40	60	80	100	120	140	160	180	200	220	240	260	280	300	320
0	T	696	1470	2142	1451	1094	877	732	628	550	489	440	400	367	338	314	293	275
	S	405	856	2868	1912	1434	1147	956	819	717	637	574	521	478	441	410	382	358
20	T	696	1470	3877	2585	1939	1551	1293	1108	970	862	776	705	647	597	555	517	485
	S	405	856	2867	1911	1433	1147	955	819	716	637	573	521	477	441	409	382	358
40	T	696	1470	4925	3283	2462	1970	1642	1407	1231	1094	985	895	821	758	704	657	616
	S	405	856	2867	1911	1433	1147	955	819	716	637	573	521	477	441	409	382	358
60	T	696	1470	4925	3283	2462	1970	1642	1407	1231	1094	985	895	821	758	704	657	616
	S	405	856	2867	1911	1433	1147	955	819	716	637	573	521	477	441	409	382	358
80	T	696	1470	4925	3283	2462	1970	1642	1407	1231	1094	985	895	821	758	704	657	616
	S	405	856	2867	1911	1433	1147	955	819	716	637	573	521	477	441	409	382	358
100	T	696	1470	4925	3283	2462	1970	1642	1407	1231	1094	985	895	821	758	704	657	616
	S	405	856	2867	1911	1433	1147	955	819	716	637	573	521	477	441	409	382	358
120	T	696	1470	4925	3283	2462	1970	1642	1407	1231	1094	985	895	821	758	704	657	616
	S	405	856	2867	1911	1433	1147	955	819	716	637	573	521	477	441	409	382	358
140	T	696	1470	4925	3283	2462	1970	1642	1407	1231	1094	985	895	821	758	704	657	616
	S	405	856	2867	1911	1433	1147	955	819	716	637	573	521	477	441	409	382	358
160	T	696	1470	4925	3283	2462	1970	1642	1407	1231	1094	985	895	821	758	704	657	616
	S	405	856	2867	1911	1433	1147	955	819	716	637	573	521	477	441	409	382	358
180	T	696	1470	4925	3283	2462	1970	1642	1407	1231	1094	985	895	821	758	704	657	616
	S	405	856	2867	1911	1433	1147	955	819	716	637	573	521	477	441	409	382	358
200	T	696	1470	4925	3283	2462	1970	1642	1407	1231	1094	985	895	821	758	704	657	616
	S	405	856	2867	1911	1433	1147	955	819	716	637	573	521	477	441	409	382	358
220	T	696	1470	4925	3283	2462	1970	1642	1407	1231	1094	985	895	821	758	704	657	616
	S	405	856	2867	1911	1433	1147	955	819	716	637	573	521	477	441	409	382	358
240	T	696	1470	4925	3283	2462	1970	1642	1407	1231	1094	985	895	821	758	704	657	616
	S	405	856	2867	1911	1433	1147	955	819	716	637	573	521	477	441	409	382	358

Characteristic load-carrying capacity $F_{4/5,Rk}$ (N) for two angle brackets

b / e (mm)		0	20	40	60	80	100	120	140	160	180	200	220	240	260	280	300	320
0	T	18120	18120	18120	18120	18120	18120	18120	18120	18120	18120	18120	18120	18120	18120	18120	18120	18120
	S	-	-	-	-	-	-	-	-	-	-	-	-	-	-	-	-	-
20	T	18120	3492	1770	1183	888	711	592	508	444	395	355	323	296	273	254	237	222
	S	-	4629	2314	1543	1157	926	771	661	579	514	463	421	386	356	331	309	289
40	T	18120	6625	3492	2352	1770	1419	1183	1015	888	790	711	646	592	547	508	474	444
	S	-	9257	4629	3086	2314	1851	1543	1322	1157	1029	926	842	771	712	661	617	579
60	T	18120	9198	5120	3492	2640	2120	1770	1519	1330	1183	1065	969	888	820	761	711	666
	S	-	13886	6943	4629	3471	2777	2314	1984	1736	1543	1389	1262	1157	1068	992	926	868
80	T	18120	11194	6625	4590	3492	2812	2352	2020	1770	1575	1419	1290	1183	1093	1015	947	888
	S	-	18514	9257	6171	4629	3703	3086	2645	2314	2057	1851	1683	1543	1424	1322	1234	1157
100	T	18120	12696	7986	5637	4320	3492	2926	2517	2207	1965	1770	1611	1477	1364	1267	1183	1110
	S	-	23143	11572	7714	5786	4629	3857	3306	2893	2571	2314	2104	1929	1780	1653	1543	1446
120	T	18120	13816	9198	6625	5120	4156	3492	3008	2640	2352	2120	1930	1770	1635	1519	1419	1330
	S	-	27772	13886	9257	6943	5554	4629	3967	3471	3086	2777	2525	2314	2136	1984	1851	1736
140	T	18120	14653	10264	7549	5889	4804	4047	3492	3069	2736	2468	2247	2062	1905	1770	1653	1551
	S	-	32400	16200	10800	8100	6480	5400	4629	4050	3600	3240	2945	2700	2492	2314	2160	2025
160	T	18120	15286	11194	8407	6625	5432	4590	3968	3492	3116	2812	2562	2352	2174	2020	1887	1770
	S	-	37029	18514	12343	9257	7406	6171	5290	4629	4114	3703	3366	3086	2848	2645	2469	2314
180	T	18120	15771	11999	9198	7324	6039	5120	4436	3909	3492	3154	2874	2640	2441	2269	2120	1989
	S	-	41657	20829	13886	10414	8331	6943	5951	5207	4629	4166	3787	3471	3204	2976	2777	2604
200	T	18120	16147	12696	9925	7986	6625	5637	4895	4320	3863	3492	3185	2926	2706	2517	2352	2207
	S	-	46286	23143	15429	11572	9257	7714	6612	5786	5143	4629	4208	3857	3560	3306	3086	2893
220	T	18120	16443	13297	10589	8611	7187	6138	5343	4724	4229	3826	3492	3210	2970	2763	2583	2424
	S	-	50915	25457	16972	12729	10183	8486	7274	6364	5657	5091	4629	4243	3917	3637	3394	3182
240	T	18120	16680	13816	11194	9198	7726	6625	5782	5120	4590	4156	3796	3492	3232	3008	2812	2640
	S	-	55543	27772	18514	13886	11109	9257	7935	6943	6171	5554	5049	4629	4273	3967	3703	3471

TTM: Timber-Timber-Maximum | TTP: Timber-Timber-Partial | TCM: Timber-Concrete-Maximum | TCP: Timber-Concrete-Partial

T: $F_{1,T,Rk}$ load-carrying capacity of timber | S: $F_{1,S,Rk}$ load-carrying capacity of steel

Table B. 18 Angle bracket type 5502S, Variant TCM, Fastener GH Nail 4x40, Density 350 kg/m³

Characteristic load-carrying capacity $F_{1,Rk}$ (N) for one / two angle brackets															
angle bracket	1													2	
f (mm)	0	10	20	30	40	50	60	70	80	90	100	110	120	0	
$F_{1,Rk}$	T	9450	450	225	150	113	90	75	64	56	50	45	41	38	18900
	S	28	23	20	18	16	14	13	12	11	10	9	8	8	
k_t (-)		9,6	11,5	13,3	15,1	16,9	18,7	20,5	22,4	24,2	26,0	27,8	29,6	31,5	4,8

Characteristic load-carrying capacity $F_{2/3,Rk}$ (N) for one / two angle brackets			
angle bracket	1	2	
$F_{2/3,Rk}$	T	1300	2600
	S	-	-

Characteristic load-carrying capacity $F_{4,Rk}$ (N) for one angle bracket																	
e (mm)	0	20	40	60	80	100	120	140	160	180	200	220	240	260	280	300	320
$F_{4,Rk}$	T	-	-	1125	188	102	70	54	43	36	31	27	24	22	20	18	16
	S	-	74	37	24	18	14	11	9	7	6	5	5	4	4	3	3
k_t (-)		0,0	3,6	7,3	10,9	14,5	18,2	21,8	25,5	29,1	32,7	36,4	40,0	43,6	47,3	50,9	54,5

Characteristic load-carrying capacity $F_{5,Rk}$ (N) for one angle bracket																	
b / e (mm)	0	20	40	60	80	100	120	140	160	180	200	220	240	260	280	300	320
0	T	125	281	1508	1005	754	603	503	431	377	335	302	274	251	232	215	188
	S	26	60	323	215	161	129	107	92	80	71	64	58	53	49	46	43
20	T	125	281	1508	1005	754	603	503	431	377	335	302	274	251	232	215	188
	S	26	60	323	215	161	129	107	92	80	71	64	58	53	49	46	43
40	T	125	281	1508	1005	754	603	503	431	377	335	302	274	251	232	215	188
	S	26	60	323	215	161	129	107	92	80	71	64	58	53	49	46	43
60	T	125	281	1508	1005	754	603	503	431	377	335	302	274	251	232	215	188
	S	26	60	323	215	161	129	107	92	80	71	64	58	53	49	46	43
80	T	125	281	1508	1005	754	603	503	431	377	335	302	274	251	232	215	188
	S	26	60	323	215	161	129	107	92	80	71	64	58	53	49	46	43
100	T	125	281	1508	1005	754	603	503	431	377	335	302	274	251	232	215	188
	S	26	60	323	215	161	129	107	92	80	71	64	58	53	49	46	43
120	T	125	281	1508	1005	754	603	503	431	377	335	302	274	251	232	215	188
	S	26	60	323	215	161	129	107	92	80	71	64	58	53	49	46	43
140	T	125	281	1508	1005	754	603	503	431	377	335	302	274	251	232	215	188
	S	26	60	323	215	161	129	107	92	80	71	64	58	53	49	46	43
160	T	125	281	1508	1005	754	603	503	431	377	335	302	274	251	232	215	188
	S	26	60	323	215	161	129	107	92	80	71	64	58	53	49	46	43
180	T	125	281	1508	1005	754	603	503	431	377	335	302	274	251	232	215	188
	S	26	60	323	215	161	129	107	92	80	71	64	58	53	49	46	43
200	T	125	281	1508	1005	754	603	503	431	377	335	302	274	251	232	215	188
	S	26	60	323	215	161	129	107	92	80	71	64	58	53	49	46	43
220	T	125	281	1508	1005	754	603	503	431	377	335	302	274	251	232	215	188
	S	26	60	323	215	161	129	107	92	80	71	64	58	53	49	46	43
240	T	125	281	1508	1005	754	603	503	431	377	335	302	274	251	232	215	188
	S	26	60	323	215	161	129	107	92	80	71	64	58	53	49	46	43
$k_x \times b$ (-)		0,0	16,7	33,4	50,1	66,8	83,5	100,2	116,9	133,6	150,3	167,0	183,7	200,3	217,0	233,7	250,4

Characteristic load-carrying capacity $F_{4/5,Rk}$ (N) for two angle brackets																	
b / e (mm)	0	20	40	60	80	100	120	140	160	180	200	220	240	260	280	300	320
0	T	8999	8999	8999	8999	8999	8999	8999	8999	8999	8999	8999	8999	8999	8999	8999	8999
	S	-	-	-	-	-	-	-	-	-	-	-	-	-	-	-	-
20	T	8999	9000	4725	3150	2363	1890	1575	1350	1181	1050	945	859	788	727	675	630
	S	-	28	14	9	7	5	4	4	3	3	2	2	2	2	2	1
40	T	8999	9000	9000	6300	4725	3780	3150	2700	2363	2100	1890	1718	1575	1454	1350	1260
	S	-	56	28	18	14	11	9	8	7	6	5	5	4	4	4	3
60	T	8999	9000	9000	9000	7088	5670	4725	4050	3544	3150	2835	2577	2363	2181	2025	1890
	S	-	84	42	28	21	16	14	12	10	9	8	7	7	6	6	5
80	T	8999	9000	9000	9000	9000	7560	6300	5400	4725	4200	3780	3436	3150	2908	2700	2520
	S	-	112	56	37	28	22	18	16	14	12	11	10	9	8	8	7
100	T	8999	9000	9000	9000	9000	7875	6750	5906	5250	4725	4295	3938	3635	3375	3150	2953
	S	-	141	70	47	35	28	23	20	17	15	14	12	11	10	10	9
120	T	8999	9000	9000	9000	9000	9000	9000	8100	7088	6300	5670	5155	4725	4362	4050	3780
	S	-	169	84	56	42	33	28	24	21	18	16	15	14	13	12	11
140	T	8999	9000	9000	9000	9000	9000	9000	8269	7350	6615	6014	5513	5088	4725	4410	4134
	S	-	197	98	65	49	39	32	28	24	21	19	17	16	15	14	13
160	T	8999	9000	9000	9000	9000	9000	9000	8400	7560	6873	6300	5815	5400	5040	4725	4410
	S	-	225	112	75	56	45	37	32	28	25	22	20	18	17	16	15
180	T	8999	9000	9000	9000	9000	9000	9000	9000	9000	8505	7732	7088	6542	6075	5670	5316
	S	-	254	127	84	63	50	42	36	31	28	25	23	21	19	18	16
200	T	8999	9000	9000	9000	9000	9000	9000	9000	9000	9000	9000	8591	7875	7269	6750	6300
	S	-	282	141	94	70	56	47	40	35	31	28	25	23	21	20	18
220	T	8999	9000	9000	9000	9000	9000	9000	9000	9000	9000	9000	9000	8663	7996	7425	6930
	S	-	310	155	103	77	62	51	44	38	34	31	28	25	23	22	20
240	T	8999	9000	9000	9000	9000	9000	9000	9000	9000	9000	9000	9000	9000	8723	8100	7560
	S	-	338	169	112	84	67	56	48	42	37	33	30	28	26	24	22
$k_x \times b$ (-)		0,0	192,7	385,5	578,2	770,9	963,6	1156,4	1349,1	1541,8	1734,5	1927,3	2120,0	2312,7	2505,5	2698,2	2890,9

TTM: Timber-Timber-Maximum | TTP: Timber-Timber-Partial | TCM: Timber-Concrete-Maximum | TCP: Timber-Concrete-Partial

T: $F_{T,Rk}$ load-carrying capacity of timber | S: $F_{S,Rk}$ load-carrying capacity of steel

Table B. 19 Angle bracket type 5502S, Variant TCM, Fastener GH Nail 4x60, Density 350 kg/m³Characteristic load-carrying capacity $F_{1,Rk}$ (N) for one / two angle brackets

angle bracket		1													2
f (mm)		0	10	20	30	40	50	60	70	80	90	100	110	120	0
$F_{1,Rk}$	T	11820	750	375	250	188	150	125	107	94	83	75	68	63	23640
	S	28	23	20	18	16	14	13	12	11	10	9	8	8	
$k_t (-)$		9,6	11,5	13,3	15,1	16,9	18,7	20,5	22,4	24,2	26,0	27,8	29,6	31,5	4,8

Characteristic load-carrying capacity $F_{2/3,Rk}$ (N) for one / two angle brackets

angle bracket		1	2
$F_{2/3,Rk}$	T	2000	4000
	S	-	-

Characteristic load-carrying capacity $F_{4,Rk}$ (N) for one angle bracket

e (mm)		0	20	40	60	80	100	120	140	160	180	200	220	240	260	280	300	320
$F_{4,Rk}$	T	-	-	1875	313	170	117	89	72	60	52	46	41	37	33	31	28	26
	S	-	74	37	24	18	14	11	9	7	6	5	5	4	4	3	3	3
$k_t (-)$		0,0	3,6	7,3	10,9	14,5	18,2	21,8	25,5	29,1	32,7	36,4	40,0	43,6	47,3	50,9	54,5	58,2

Characteristic load-carrying capacity $F_{5,Rk}$ (N) for one angle bracket

b / e (mm)		0	20	40	60	80	100	120	140	160	180	200	220	240	260	280	300	320
0	T	208	469	2513	1675	1256	1005	838	718	628	558	503	457	419	387	359	335	314
	S	26	60	323	215	161	129	107	92	80	71	64	58	53	49	46	43	40
20	T	208	469	2513	1675	1256	1005	838	718	628	558	503	457	419	387	359	335	314
	S	26	60	323	215	161	129	107	92	80	71	64	58	53	49	46	43	40
40	T	208	469	2513	1675	1256	1005	838	718	628	558	503	457	419	387	359	335	314
	S	26	60	323	215	161	129	107	92	80	71	64	58	53	49	46	43	40
60	T	208	469	2513	1675	1256	1005	838	718	628	558	503	457	419	387	359	335	314
	S	26	60	323	215	161	129	107	92	80	71	64	58	53	49	46	43	40
80	T	208	469	2513	1675	1256	1005	838	718	628	558	503	457	419	387	359	335	314
	S	26	60	323	215	161	129	107	92	80	71	64	58	53	49	46	43	40
100	T	208	469	2513	1675	1256	1005	838	718	628	558	503	457	419	387	359	335	314
	S	26	60	323	215	161	129	107	92	80	71	64	58	53	49	46	43	40
120	T	208	469	2513	1675	1256	1005	838	718	628	558	503	457	419	387	359	335	314
	S	26	60	323	215	161	129	107	92	80	71	64	58	53	49	46	43	40
140	T	208	469	2513	1675	1256	1005	838	718	628	558	503	457	419	387	359	335	314
	S	26	60	323	215	161	129	107	92	80	71	64	58	53	49	46	43	40
160	T	208	469	2513	1675	1256	1005	838	718	628	558	503	457	419	387	359	335	314
	S	26	60	323	215	161	129	107	92	80	71	64	58	53	49	46	43	40
180	T	208	469	2513	1675	1256	1005	838	718	628	558	503	457	419	387	359	335	314
	S	26	60	323	215	161	129	107	92	80	71	64	58	53	49	46	43	40
200	T	208	469	2513	1675	1256	1005	838	718	628	558	503	457	419	387	359	335	314
	S	26	60	323	215	161	129	107	92	80	71	64	58	53	49	46	43	40
220	T	208	469	2513	1675	1256	1005	838	718	628	558	503	457	419	387	359	335	314
	S	26	60	323	215	161	129	107	92	80	71	64	58	53	49	46	43	40
240	T	208	469	2513	1675	1256	1005	838	718	628	558	503	457	419	387	359	335	314
	S	26	60	323	215	161	129	107	92	80	71	64	58	53	49	46	43	40
$k_x \times b (-)$		0,0	16,7	33,4	50,1	66,8	83,5	100,2	116,9	133,6	150,3	167,0	183,7	200,3	217,0	233,7	250,4	267,1

Characteristic load-carrying capacity $F_{4/5,Rk}$ (N) for two angle brackets

b / e (mm)		0	20	40	60	80	100	120	140	160	180	200	220	240	260	280	300	320
0	T	15000	15000	15000	15000	15000	15000	15000	15000	15000	15000	15000	15000	15000	15000	15000	15000	15000
	S	-	-	-	-	-	-	-	-	-	-	-	-	-	-	-	-	-
20	T	15000	11820	5910	3940	2955	2364	1970	1689	1478	1313	1182	1075	985	909	844	788	739
	S	-	28	14	9	7	5	4	4	3	3	2	2	2	2	2	1	1
40	T	15000	15000	11820	7880	5910	4728	3940	3377	2955	2627	2364	2149	1970	1818	1689	1576	1478
	S	-	56	28	18	14	11	9	8	7	6	5	5	4	4	4	3	3
60	T	15000	15000	15000	11820	8865	7092	5910	5066	4433	3940	3546	3224	2955	2728	2533	2364	2216
	S	-	84	42	28	21	16	14	12	10	9	8	7	7	6	6	5	5
80	T	15000	15000	15000	15000	11820	9456	7880	6754	5910	5253	4728	4298	3940	3637	3377	3152	2955
	S	-	112	56	37	28	22	18	16	14	12	11	10	9	8	8	7	7
100	T	15000	15000	15000	15000	14775	11820	9850	8443	7388	6567	5910	5373	4925	4546	4221	3940	3694
	S	-	141	70	47	35	28	23	20	17	15	14	12	11	10	10	9	8
120	T	15000	15000	15000	15000	15000	14184	11820	10131	8865	7880	7092	6447	5910	5455	5066	4728	4433
	S	-	169	84	56	42	33	28	24	21	18	16	15	14	13	12	11	10
140	T	15000	15000	15000	15000	15000	13790	11820	10343	9193	8274	7522	6895	6365	5910	5516	5171	4868
	S	-	197	98	65	49	39	32	28	24	21	19	17	16	15	14	13	12
160	T	15000	15000	15000	15000	15000	15000	13509	11820	10507	9456	8596	7880	7274	6754	6304	5910	5516
	S	-	225	112	75	56	45	37	32	28	25	22	20	18	17	16	15	14
180	T	15000	15000	15000	15000	15000	15000	15000	13298	11820	10638	9671	8865	8183	7599	7092	6649	6249
	S	-	254	127	84	63	50	42	36	31	28	25	23	21	19	18	16	15
200	T	15000	15000	15000	15000	15000	15000	15000	14775	13133	11820	10745	9850	9092	8443	7880	7388	6948
	S	-	282	141	94	70	56	47	40	35	31	28	25	23	21	20	18	17
220	T	15000	15000	15000	15000	15000	15000	15000	15000	14447	13002	11820	10835	10002	9287	8668	8126	7686
	S	-	310	155	103	77	62	51	44	38	34	31	28	25	23	22	20	19
240	T	15000	15000	15000	15000	15000	15000	15000	15000	15000	14184	12895	11820	10911	10131	9456	8865	8366
	S	-	338	169	112	84	67	56	48	42	37	33	30	28	26	24	22	21
$k_x \times b (-)$		0,0	192,7	385,5	578,2	770,9	963,6	1156,4	1349,1	1541,8	1734,5	1927,3	2120,0	2312,7	2505,5	2698,2	2890,9	3083,6

TTM: Timber-Timber-Maximum | TTP: Timber-Timber-Partial | TCM: Timber-Concrete-Maximum | TCP: Timber-Concrete-Partial

T: $F_{1,T,Rk}$ load-carrying capacity of timber | S: $F_{1,S,Rk}$ load-carrying capacity of steel

Table B. 20 Angle bracket type 5502S, Variant TCM, Fastener GH Screw 5x40, Density 350 kg/m³

Characteristic load-carrying capacity $F_{1,Rk}$ (N) for one / two angle brackets															
angle bracket	1													2	
f (mm)	0	10	20	30	40	50	60	70	80	90	100	110	120	0	
$F_{1,Rk}$	T	10015	945	473	315	236	189	158	135	118	105	95	86	79	20030
	S	28	23	20	18	16	14	13	12	11	10	9	8	8	56
k_1 (-)	9,6	11,5	13,3	15,1	16,9	18,7	20,5	22,4	24,2	26,0	27,8	29,6	31,5	4,8	

Characteristic load-carrying capacity $F_{2/3,Rk}$ (N) for one / two angle brackets		
angle bracket	1	2
$F_{2/3,Rk}$	T	2130
	S	-

Characteristic load-carrying capacity $F_{4,Rk}$ (N) for one angle bracket																		
e (mm)	0	20	40	60	80	100	120	140	160	180	200	220	240	260	280	300	320	
$F_{4,Rk}$	T	-	-	2363	394	215	148	113	91	76	66	58	51	46	42	39	36	33
	S	-	74	37	24	18	14	11	9	7	6	5	5	4	4	3	3	3
k_1 (-)	0,0	3,6	7,3	10,9	14,5	18,2	21,8	25,5	29,1	32,7	36,4	40,0	43,6	47,3	50,9	54,5	58,2	

Characteristic load-carrying capacity $F_{5,Rk}$ (N) for one angle bracket																		
b / e (mm)	0	20	40	60	80	100	120	140	160	180	200	220	240	260	280	300	320	
0	T	263	591	3166	2111	1583	1266	1055	905	791	704	633	576	528	487	452	422	396
	S	26	60	323	215	161	129	107	92	80	71	64	58	53	49	46	43	40
20	T	263	591	3166	2111	1583	1266	1055	905	791	704	633	576	528	487	452	422	396
	S	26	60	323	215	161	129	107	92	80	71	64	58	53	49	46	43	40
40	T	263	591	3166	2111	1583	1266	1055	905	791	704	633	576	528	487	452	422	396
	S	26	60	323	215	161	129	107	92	80	71	64	58	53	49	46	43	40
60	T	263	591	3166	2111	1583	1266	1055	905	791	704	633	576	528	487	452	422	396
	S	26	60	323	215	161	129	107	92	80	71	64	58	53	49	46	43	40
80	T	263	591	3166	2111	1583	1266	1055	905	791	704	633	576	528	487	452	422	396
	S	26	60	323	215	161	129	107	92	80	71	64	58	53	49	46	43	40
100	T	263	591	3166	2111	1583	1266	1055	905	791	704	633	576	528	487	452	422	396
	S	26	60	323	215	161	129	107	92	80	71	64	58	53	49	46	43	40
120	T	263	591	3166	2111	1583	1266	1055	905	791	704	633	576	528	487	452	422	396
	S	26	60	323	215	161	129	107	92	80	71	64	58	53	49	46	43	40
140	T	263	591	3166	2111	1583	1266	1055	905	791	704	633	576	528	487	452	422	396
	S	26	60	323	215	161	129	107	92	80	71	64	58	53	49	46	43	40
160	T	263	591	3166	2111	1583	1266	1055	905	791	704	633	576	528	487	452	422	396
	S	26	60	323	215	161	129	107	92	80	71	64	58	53	49	46	43	40
180	T	263	591	3166	2111	1583	1266	1055	905	791	704	633	576	528	487	452	422	396
	S	26	60	323	215	161	129	107	92	80	71	64	58	53	49	46	43	40
200	T	263	591	3166	2111	1583	1266	1055	905	791	704	633	576	528	487	452	422	396
	S	26	60	323	215	161	129	107	92	80	71	64	58	53	49	46	43	40
220	T	263	591	3166	2111	1583	1266	1055	905	791	704	633	576	528	487	452	422	396
	S	26	60	323	215	161	129	107	92	80	71	64	58	53	49	46	43	40
240	T	263	591	3166	2111	1583	1266	1055	905	791	704	633	576	528	487	452	422	396
	S	26	60	323	215	161	129	107	92	80	71	64	58	53	49	46	43	40
$k_1 \times b$ (-)	0,0	16,7	33,4	50,1	66,8	83,5	100,2	116,9	133,6	150,3	167,0	183,7	200,3	217,0	233,7	250,4	267,1	

Characteristic load-carrying capacity $F_{4/5,Rk}$ (N) for two angle brackets																		
b / e (mm)	0	20	40	60	80	100	120	140	160	180	200	220	240	260	280	300	320	
0	T	18899	18899	18899	18899	18899	18899	18899	18899	18899	18899	18899	18899	18899	18899	18899	18899	
	S	-	-	-	-	-	-	-	-	-	-	-	-	-	-	-	-	
20	T	18899	10015	5008	3338	2504	2003	1669	1431	1252	1113	1002	910	835	770	715	668	626
	S	-	28	14	9	7	5	4	4	3	3	2	2	2	2	2	1	1
40	T	18899	18900	10015	6677	5008	4006	3338	2861	2504	2226	2003	1821	1669	1541	1431	1335	1252
	S	-	56	28	18	14	11	9	8	7	6	5	5	4	4	4	3	3
60	T	18899	18900	15023	10015	7511	6009	5008	4292	3756	3338	3005	2731	2504	2311	2146	2003	1878
	S	-	84	42	28	21	16	14	12	10	9	8	7	7	6	6	5	5
80	T	18899	18900	18900	13353	10015	8012	6677	5723	5008	4451	4006	3642	3338	3082	2861	2671	2504
	S	-	112	56	37	28	22	18	16	14	12	11	10	9	8	8	7	7
100	T	18899	18900	18900	16692	12519	10015	8346	7154	6259	5564	5008	4552	4173	3852	3577	3338	3130
	S	-	141	70	47	35	28	23	20	17	15	14	12	11	10	10	9	8
120	T	18899	18900	18900	18900	15023	12018	10015	8584	7511	6677	6009	5463	5008	4622	4292	4006	3756
	S	-	169	84	56	42	33	28	24	21	18	16	15	14	13	12	11	10
140	T	18899	18900	18900	18900	17526	14021	11684	10015	8763	7789	7011	6373	5842	5393	5008	4674	4382
	S	-	197	98	65	49	39	32	28	24	21	19	17	16	15	14	13	12
160	T	18899	18900	18900	18900	18900	16024	13353	11446	10015	8902	8012	7284	6677	6163	5723	5341	5008
	S	-	225	112	75	56	45	37	32	28	25	22	20	18	17	16	15	14
180	T	18899	18900	18900	18900	18900	18027	15023	12876	11267	10015	9014	8194	7511	6933	6438	6009	5633
	S	-	254	127	84	63	50	42	36	31	28	25	23	21	19	18	16	15
200	T	18899	18900	18900	18900	18900	16692	14307	12519	11128	10015	9105	8346	7704	7154	6677	6259	5885
	S	-	282	141	94	70	56	47	40	35	31	28	25	23	21	20	18	17
220	T	18899	18900	18900	18900	18900	18361	15738	13771	12241	11017	10015	9180	8474	7869	7344	6885	6485
	S	-	310	155	103	77	62	51	44	38	34	31	28	25	23	22	20	19
240	T	18899	18900	18900	18900	18900	18900	17169	15023	13353	12018	10925	10015	9245	8584	8012	7511	7011
	S	-	338	169	112	84	67	56	48	42	37	33	30	28	26	24	22	21
$k_1 \times b$ (-)	0,0	192,7	385,5	578,2	770,9	963,6	1156,4	1349,1	1541,8	1734,5	1927,3	2120,0	2312,7	2505,5	2698,2	2890,9	3083,6	

TTM: Timber-Timber-Maximum | TTP: Timber-Timber-Partial | TCM: Timber-Concrete-Maximum | TCP: Timber-Concrete-Partial

T: $F_{1,T,Rk}$ load-carrying capacity of timber | S: $F_{1,S,Rk}$ load-carrying capacity of steel

Table B. 21 Angle bracket type 5502S, Variant TCM, Fastener GH Screw 5x60, Density 350 kg/m³

Characteristic load-carrying capacity $F_{1,Rk}$ (N) for one / two angle brackets															
angle bracket	1													2	
f (mm)	0	10	20	30	40	50	60	70	80	90	100	110	120	0	
$F_{1,Rk}$	T	11325	1470	735	490	368	294	245	210	184	163	147	134	123	22650
	S	28	23	20	18	16	14	13	12	11	10	9	8	8	56
k_t (-)	9,6	11,5	13,3	15,1	16,9	18,7	20,5	22,4	24,2	26,0	27,8	29,6	31,5	4,8	

Characteristic load-carrying capacity $F_{2/3,Rk}$ (N) for one / two angle brackets			
angle bracket	1	2	
$F_{2/3,Rk}$	T	2740	5480
	S	-	-

Characteristic load-carrying capacity $F_{4,Rk}$ (N) for one angle bracket																		
e (mm)	0	20	40	60	80	100	120	140	160	180	200	220	240	260	280	300	320	
$F_{4,Rk}$	T	-	-	3675	613	334	230	175	141	119	102	90	80	72	66	60	56	52
	S	-	74	37	24	18	14	11	9	7	6	5	5	4	4	3	3	3
k_t (-)	0,0	3,6	7,3	10,9	14,5	18,2	21,8	25,5	29,1	32,7	36,4	40,0	43,6	47,3	50,9	54,5	58,2	

Characteristic load-carrying capacity $F_{5,Rk}$ (N) for one angle bracket																		
b / e (mm)	0	20	40	60	80	100	120	140	160	180	200	220	240	260	280	300	320	
0	T	408	919	4925	3283	2462	1970	1642	1407	1231	1094	985	895	821	758	704	657	616
	S	26	60	323	215	161	129	107	92	80	71	64	58	53	49	46	43	40
20	T	408	919	4925	3283	2462	1970	1642	1407	1231	1094	985	895	821	758	704	657	616
	S	26	60	323	215	161	129	107	92	80	71	64	58	53	49	46	43	40
40	T	408	919	4925	3283	2462	1970	1642	1407	1231	1094	985	895	821	758	704	657	616
	S	26	60	323	215	161	129	107	92	80	71	64	58	53	49	46	43	40
60	T	408	919	4925	3283	2462	1970	1642	1407	1231	1094	985	895	821	758	704	657	616
	S	26	60	323	215	161	129	107	92	80	71	64	58	53	49	46	43	40
80	T	408	919	4925	3283	2462	1970	1642	1407	1231	1094	985	895	821	758	704	657	616
	S	26	60	323	215	161	129	107	92	80	71	64	58	53	49	46	43	40
100	T	408	919	4925	3283	2462	1970	1642	1407	1231	1094	985	895	821	758	704	657	616
	S	26	60	323	215	161	129	107	92	80	71	64	58	53	49	46	43	40
120	T	408	919	4925	3283	2462	1970	1642	1407	1231	1094	985	895	821	758	704	657	616
	S	26	60	323	215	161	129	107	92	80	71	64	58	53	49	46	43	40
140	T	408	919	4925	3283	2462	1970	1642	1407	1231	1094	985	895	821	758	704	657	616
	S	26	60	323	215	161	129	107	92	80	71	64	58	53	49	46	43	40
160	T	408	919	4925	3283	2462	1970	1642	1407	1231	1094	985	895	821	758	704	657	616
	S	26	60	323	215	161	129	107	92	80	71	64	58	53	49	46	43	40
180	T	408	919	4925	3283	2462	1970	1642	1407	1231	1094	985	895	821	758	704	657	616
	S	26	60	323	215	161	129	107	92	80	71	64	58	53	49	46	43	40
200	T	408	919	4925	3283	2462	1970	1642	1407	1231	1094	985	895	821	758	704	657	616
	S	26	60	323	215	161	129	107	92	80	71	64	58	53	49	46	43	40
220	T	408	919	4925	3283	2462	1970	1642	1407	1231	1094	985	895	821	758	704	657	616
	S	26	60	323	215	161	129	107	92	80	71	64	58	53	49	46	43	40
240	T	408	919	4925	3283	2462	1970	1642	1407	1231	1094	985	895	821	758	704	657	616
	S	26	60	323	215	161	129	107	92	80	71	64	58	53	49	46	43	40
$k_x \times b$ (-)	0,0	16,7	33,4	50,1	66,8	83,5	100,2	116,9	133,6	150,3	167,0	183,7	200,3	217,0	233,7	250,4	267,1	

Characteristic load-carrying capacity $F_{4/5,Rk}$ (N) for two angle brackets																		
b / e (mm)	0	20	40	60	80	100	120	140	160	180	200	220	240	260	280	300	320	
0	T	29399	29399	29399	29399	29399	29399	29399	29399	29399	29399	29399	29399	29399	29399	29399	29399	
	S	-	-	-	-	-	-	-	-	-	-	-	-	-	-	-	-	
20	T	29399	11325	5663	3775	2831	2265	1888	1618	1416	1258	1133	1030	944	871	809	755	708
	S	-	28	14	9	7	5	4	4	3	3	2	2	2	2	2	1	1
40	T	29399	22650	11325	7550	5663	4530	3775	3236	2831	2517	2265	2059	1888	1742	1618	1510	1416
	S	-	56	28	18	14	11	9	8	7	6	5	5	4	4	4	3	3
60	T	29399	29400	16988	11325	8494	6795	5663	4854	4247	3775	3398	3089	2831	2613	2427	2265	2123
	S	-	84	42	28	21	16	14	12	10	9	8	7	7	6	6	5	5
80	T	29399	29400	22650	15100	11325	9060	7550	6471	5663	5033	4530	4118	3775	3485	3236	3020	2831
	S	-	112	56	37	28	22	18	16	14	12	11	10	9	8	8	7	7
100	T	29399	29400	28313	18875	14156	11325	9438	8089	7078	6292	5663	5148	4719	4356	4045	3775	3539
	S	-	141	70	47	35	28	23	20	17	15	14	12	11	10	10	9	8
120	T	29399	29400	29400	22650	16988	13590	11325	9707	8494	7550	6795	6177	5663	5227	4854	4530	4247
	S	-	169	84	56	42	33	28	24	21	18	16	15	14	13	12	11	10
140	T	29399	29400	29400	26425	19819	15855	13213	11325	9909	8808	7928	7207	6606	6098	5663	5285	4955
	S	-	197	98	65	49	39	32	28	24	21	19	17	16	15	14	13	12
160	T	29399	29400	29400	26500	18120	15100	12943	11325	10067	9060	8236	7550	6969	6471	6040	5663	
	S	-	225	112	75	56	45	37	32	28	25	22	20	18	17	16	15	14
180	T	29399	29400	29400	29400	25481	20385	16988	14561	12741	11325	10193	9266	8494	7840	7280	6795	6370
	S	-	254	127	84	63	50	42	36	31	28	25	23	21	19	18	16	15
200	T	29399	29400	29400	29400	28313	22650	18875	16179	14156	12583	11325	10295	9438	8712	8089	7550	7078
	S	-	282	141	94	70	56	47	40	35	31	28	25	23	21	20	18	17
220	T	29399	29400	29400	29400	29400	24915	20763	17796	15572	13842	12458	11325	10381	9583	8898	8305	7786
	S	-	310	155	103	77	62	51	44	38	34	31	28	25	23	22	20	19
240	T	29399	29400	29400	29400	29400	27180	22650	19414	16988	15100	13590	12355	11325	10454	9707	9060	8494
	S	-	338	169	112	84	67	56	48	42	37	33	30	28	26	24	22	21
$k_x \times b$ (-)	0,0	192,7	385,5	578,2	770,9	963,6	1156,4	1349,1	1541,8	1734,5	1927,3	2120,0	2312,7	2505,5	2698,2	2890,9	3083,6	

TTM: Timber-Timber-Maximum | TTP: Timber-Timber-Partial | TCM: Timber-Concrete-Maximum | TCP: Timber-Concrete-Partial

T: $F_{T,Rk}$ load-carrying capacity of timber | S: $F_{S,Rk}$ load-carrying capacity of steel

Table B. 22 Angle bracket type 5502S, Variant TCP, Fastener GH Nail 4x40, Density 350 kg/m³Characteristic load-carrying capacity $F_{1,Rk}$ (N) for one / two angle brackets

angle bracket	1													2	
f (mm)	0	10	20	30	40	50	60	70	80	90	100	110	120	0	
$F_{1,Rk}$	T	3780	450	225	150	113	90	75	64	56	50	45	41	38	7560
	S	28	23	20	18	16	14	13	12	11	10	9	8	8	56
k_t (-)		9,6	11,5	13,3	15,1	16,9	18,7	20,5	22,4	24,2	26,0	27,8	29,6	31,5	4,8

Characteristic load-carrying capacity $F_{2/3,Rk}$ (N) for one / two angle brackets

angle bracket	1	2	
$F_{2/3,Rk}$	T	440	880
	S	-	-

Characteristic load-carrying capacity $F_{4,Rk}$ (N) for one angle bracket

e (mm)	0	20	40	60	80	100	120	140	160	180	200	220	240	260	280	300	320
$F_{4,Rk}$	T	-	-	1125	188	102	70	54	43	36	31	27	24	22	20	18	16
	S	-	74	37	24	18	14	11	9	7	6	5	5	4	4	3	3
k_t (-)		0,0	3,6	7,3	10,9	14,5	18,2	21,8	25,5	29,1	32,7	36,4	40,0	43,6	47,3	50,9	54,5

Characteristic load-carrying capacity $F_{5,Rk}$ (N) for one angle bracket

b / e (mm)	0	20	40	60	80	100	120	140	160	180	200	220	240	260	280	300	320
0	T	125	281	1508	1005	754	603	503	431	377	335	302	274	251	232	215	201
	S	26	60	323	215	161	129	107	92	80	71	64	58	53	49	46	43
20	T	125	281	1508	1005	754	603	503	431	377	335	302	274	251	232	215	201
	S	26	60	323	215	161	129	107	92	80	71	64	58	53	49	46	43
40	T	125	281	1508	1005	754	603	503	431	377	335	302	274	251	232	215	201
	S	26	60	323	215	161	129	107	92	80	71	64	58	53	49	46	43
60	T	125	281	1508	1005	754	603	503	431	377	335	302	274	251	232	215	201
	S	26	60	323	215	161	129	107	92	80	71	64	58	53	49	46	43
80	T	125	281	1508	1005	754	603	503	431	377	335	302	274	251	232	215	201
	S	26	60	323	215	161	129	107	92	80	71	64	58	53	49	46	43
100	T	125	281	1508	1005	754	603	503	431	377	335	302	274	251	232	215	201
	S	26	60	323	215	161	129	107	92	80	71	64	58	53	49	46	43
120	T	125	281	1508	1005	754	603	503	431	377	335	302	274	251	232	215	201
	S	26	60	323	215	161	129	107	92	80	71	64	58	53	49	46	43
140	T	125	281	1508	1005	754	603	503	431	377	335	302	274	251	232	215	201
	S	26	60	323	215	161	129	107	92	80	71	64	58	53	49	46	43
160	T	125	281	1508	1005	754	603	503	431	377	335	302	274	251	232	215	201
	S	26	60	323	215	161	129	107	92	80	71	64	58	53	49	46	43
180	T	125	281	1508	1005	754	603	503	431	377	335	302	274	251	232	215	201
	S	26	60	323	215	161	129	107	92	80	71	64	58	53	49	46	43
200	T	125	281	1508	1005	754	603	503	431	377	335	302	274	251	232	215	201
	S	26	60	323	215	161	129	107	92	80	71	64	58	53	49	46	43
220	T	125	281	1508	1005	754	603	503	431	377	335	302	274	251	232	215	201
	S	26	60	323	215	161	129	107	92	80	71	64	58	53	49	46	43
240	T	125	281	1508	1005	754	603	503	431	377	335	302	274	251	232	215	201
	S	26	60	323	215	161	129	107	92	80	71	64	58	53	49	46	43
$k_x \times b$ (-)		0,0	16,7	33,4	50,1	66,8	83,5	100,2	116,9	133,6	150,3	167,0	183,7	200,3	217,0	233,7	250,4

Characteristic load-carrying capacity $F_{4/5,Rk}$ (N) for two angle brackets

b / e (mm)	0	20	40	60	80	100	120	140	160	180	200	220	240	260	280	300	320
0	T	3600	3600	3600	3600	3600	3600	3600	3600	3600	3600	3600	3600	3600	3600	3600	3600
	S	-	-	-	-	-	-	-	-	-	-	-	-	-	-	-	-
20	T	3600	3600	1890	1260	945	756	630	540	473	420	378	344	315	291	270	252
	S	-	28	14	9	7	5	4	4	3	3	2	2	2	2	2	1
40	T	3600	3600	3600	2520	1890	1512	1260	1080	945	840	756	687	630	582	540	473
	S	-	56	28	18	14	11	9	8	7	6	5	5	4	4	3	3
60	T	3600	3600	3600	3600	2835	2268	1890	1620	1418	1260	1134	1031	945	872	810	756
	S	-	84	42	28	21	16	14	12	10	9	8	7	7	6	6	5
80	T	3600	3600	3600	3600	3600	3024	2520	2160	1890	1680	1512	1375	1260	1163	1080	1008
	S	-	112	56	37	28	22	18	16	14	12	11	10	9	8	8	7
100	T	3600	3600	3600	3600	3600	3150	2700	2367	2100	1890	1718	1575	1454	1350	1260	1181
	S	-	141	70	47	35	28	23	20	17	15	14	12	11	10	9	8
120	T	3600	3600	3600	3600	3600	3600	3240	2835	2520	2268	2062	1890	1745	1620	1512	1418
	S	-	169	84	56	42	33	28	24	21	18	16	15	14	13	12	11
140	T	3600	3600	3600	3600	3600	3600	3600	3308	2940	2646	2405	2205	2035	1890	1764	1654
	S	-	197	98	65	49	39	32	28	24	21	19	17	16	15	14	13
160	T	3600	3600	3600	3600	3600	3600	3600	3600	3360	3024	2749	2520	2326	2160	2016	1890
	S	-	225	112	75	56	45	37	32	28	25	22	20	18	17	16	15
180	T	3600	3600	3600	3600	3600	3600	3600	3600	3600	3402	3093	2835	2617	2430	2268	2126
	S	-	254	127	84	63	50	42	36	31	28	25	23	21	19	18	16
200	T	3600	3600	3600	3600	3600	3600	3600	3600	3600	3600	3436	3150	2908	2700	2520	2363
	S	-	282	141	94	70	56	47	40	35	31	28	25	23	21	20	18
220	T	3600	3600	3600	3600	3600	3600	3600	3600	3600	3600	3600	3465	3198	2970	2772	2599
	S	-	310	155	103	77	62	51	44	38	34	31	28	25	23	22	20
240	T	3600	3600	3600	3600	3600	3600	3600	3600	3600	3600	3600	3600	3489	3240	3024	2835
	S	-	338	169	112	84	67	56	48	42	37	33	30	28	26	24	22
$k_x \times b$ (-)		0,0	192,7	385,5	578,2	770,9	963,6	1156,4	1349,1	1541,8	1734,5	1927,3	2120,0	2312,7	2505,5	2698,2	2890,9

TTM: Timber-Timber-Maximum | TTP: Timber-Timber-Partial | TCM: Timber-Concrete-Maximum | TCP: Timber-Concrete-Partial

T: $F_{T,Rk}$ load-carrying capacity of timber | S: $F_{S,Rk}$ load-carrying capacity of steel

Table B. 23 Angle bracket type 5502S, Variant TCP, Fastener GH Nail 4x60, Density 350 kg/m³Characteristic load-carrying capacity $F_{1,Rk}$ (N) for one / two angle brackets

angle bracket	1													2	
f (mm)	0	10	20	30	40	50	60	70	80	90	100	110	120	0	
$F_{1,Rk}$	T	4728	750	375	250	188	150	125	107	94	83	75	68	63	9456
	S	28	23	20	18	16	14	13	12	11	10	9	8	8	56
k_t (-)	9,6	11,5	13,3	15,1	16,9	18,7	20,5	22,4	24,2	26,0	27,8	29,6	31,5	4,8	

Characteristic load-carrying capacity $F_{2/3,Rk}$ (N) for one / two angle brackets

angle bracket	1	2	
$F_{2/3,Rk}$	T	710	1420
	S	-	-

Characteristic load-carrying capacity $F_{4,Rk}$ (N) for one angle bracket

e (mm)	0	20	40	60	80	100	120	140	160	180	200	220	240	260	280	300	320	
$F_{4,Rk}$	T	-	-	1875	313	170	117	89	72	60	52	46	41	37	33	31	28	26
	S	-	74	37	24	18	14	11	9	7	6	5	5	4	4	3	3	3
k_t (-)	0,0	3,6	7,3	10,9	14,5	18,2	21,8	25,5	29,1	32,7	36,4	40,0	43,6	47,3	50,9	54,5	58,2	

Characteristic load-carrying capacity $F_{5,Rk}$ (N) for one angle bracket

b / e (mm)	0	20	40	60	80	100	120	140	160	180	200	220	240	260	280	300	320	
0	T	208	469	2513	1675	1256	1005	838	718	628	558	503	457	419	387	359	335	314
	S	26	60	323	215	161	129	107	92	80	71	64	58	53	49	46	43	40
20	T	208	469	2364	1576	1182	946	788	675	591	525	473	430	394	364	338	315	296
	S	26	60	323	215	161	129	107	92	80	71	64	58	53	49	46	43	40
40	T	208	469	2513	1675	1256	1005	838	718	628	558	503	457	419	387	359	335	314
	S	26	60	323	215	161	129	107	92	80	71	64	58	53	49	46	43	40
60	T	208	469	2513	1675	1256	1005	838	718	628	558	503	457	419	387	359	335	314
	S	26	60	323	215	161	129	107	92	80	71	64	58	53	49	46	43	40
80	T	208	469	2513	1675	1256	1005	838	718	628	558	503	457	419	387	359	335	314
	S	26	60	323	215	161	129	107	92	80	71	64	58	53	49	46	43	40
100	T	208	469	2513	1675	1256	1005	838	718	628	558	503	457	419	387	359	335	314
	S	26	60	323	215	161	129	107	92	80	71	64	58	53	49	46	43	40
120	T	208	469	2513	1675	1256	1005	838	718	628	558	503	457	419	387	359	335	314
	S	26	60	323	215	161	129	107	92	80	71	64	58	53	49	46	43	40
140	T	208	469	2513	1675	1256	1005	838	718	628	558	503	457	419	387	359	335	314
	S	26	60	323	215	161	129	107	92	80	71	64	58	53	49	46	43	40
160	T	208	469	2513	1675	1256	1005	838	718	628	558	503	457	419	387	359	335	314
	S	26	60	323	215	161	129	107	92	80	71	64	58	53	49	46	43	40
180	T	208	469	2513	1675	1256	1005	838	718	628	558	503	457	419	387	359	335	314
	S	26	60	323	215	161	129	107	92	80	71	64	58	53	49	46	43	40
200	T	208	469	2513	1675	1256	1005	838	718	628	558	503	457	419	387	359	335	314
	S	26	60	323	215	161	129	107	92	80	71	64	58	53	49	46	43	40
220	T	208	469	2513	1675	1256	1005	838	718	628	558	503	457	419	387	359	335	314
	S	26	60	323	215	161	129	107	92	80	71	64	58	53	49	46	43	40
240	T	208	469	2513	1675	1256	1005	838	718	628	558	503	457	419	387	359	335	314
	S	26	60	323	215	161	129	107	92	80	71	64	58	53	49	46	43	40
$k_x \times b$ (-)	0,0	16,7	33,4	50,1	66,8	83,5	100,2	116,9	133,6	150,3	167,0	183,7	200,3	217,0	233,7	250,4	267,1	

Characteristic load-carrying capacity $F_{4/5,Rk}$ (N) for two angle brackets

b / e (mm)	0	20	40	60	80	100	120	140	160	180	200	220	240	260	280	300	320	
0	T	5999	5999	5999	5999	5999	5999	5999	5999	5999	5999	5999	5999	5999	5999	5999	5999	
	S	-	-	-	-	-	-	-	-	-	-	-	-	-	-	-	-	
20	T	5999	4728	2364	1576	1182	946	788	675	591	525	473	430	394	364	338	315	296
	S	-	28	14	9	7	5	4	4	3	3	2	2	2	2	2	1	1
40	T	5999	6000	4728	3152	2364	1891	1576	1351	1182	1051	946	860	788	727	675	630	591
	S	-	56	28	18	14	11	9	8	7	6	5	5	4	4	3	3	3
60	T	5999	6000	6000	4728	3546	2837	2364	2026	1773	1576	1418	1289	1182	1091	1013	946	887
	S	-	84	42	28	21	16	14	12	10	9	8	7	7	6	6	5	5
80	T	5999	6000	6000	6000	4728	3782	3152	2702	2364	2101	1891	1719	1576	1455	1351	1261	1182
	S	-	112	56	37	28	22	18	16	14	12	11	10	9	8	8	7	7
100	T	5999	6000	6000	6000	5910	4728	3940	3377	2955	2627	2364	2149	1970	1818	1689	1576	1478
	S	-	141	70	47	35	28	23	20	17	15	14	12	11	10	10	9	8
120	T	5999	6000	6000	6000	6000	5674	4728	4053	3546	3152	2837	2579	2364	2182	2026	1891	1773
	S	-	169	84	56	42	33	28	24	21	18	16	15	14	13	12	11	10
140	T	5999	6000	6000	6000	6000	6000	5516	4728	4137	3677	3310	3009	2758	2546	2364	2206	2069
	S	-	197	98	65	49	39	32	28	24	21	19	17	16	15	14	13	12
160	T	5999	6000	6000	6000	6000	6000	5403	4728	4203	3782	3439	3152	2910	2702	2522	2364	
	S	-	225	112	75	56	45	37	32	28	25	22	20	18	17	16	15	14
180	T	5999	6000	6000	6000	6000	6000	6000	5319	4728	4255	3868	3546	3273	3039	2837	2660	
	S	-	254	127	84	63	50	42	36	31	28	25	23	21	19	18	16	15
200	T	5999	6000	6000	6000	6000	6000	6000	6000	5910	5253	4728	4298	3940	3637	3377	3152	2955
	S	-	282	141	94	70	56	47	40	35	31	28	25	23	21	20	18	17
220	T	5999	6000	6000	6000	6000	6000	6000	6000	6000	5779	5201	4728	4334	4001	3715	3467	3251
	S	-	310	155	103	77	62	51	44	38	34	31	28	25	23	22	20	19
240	T	5999	6000	6000	6000	6000	6000	6000	6000	6000	6000	5674	5158	4728	4364	4053	3782	3546
	S	-	338	169	112	84	67	56	48	42	37	33	30	28	26	24	22	21
$k_x \times b$ (-)	0,0	192,7	385,5	578,2	770,9	963,6	1156,4	1349,1	1541,8	1734,5	1927,3	2120,0	2312,7	2505,5	2698,2	2890,9	3083,6	

TTM: Timber-Timber-Maximum | TTP: Timber-Timber-Partial | TCM: Timber-Concrete-Maximum | TCP: Timber-Concrete-Partial

T: $F_{1,T,Rk}$ load-carrying capacity of timber | S: $F_{1,S,Rk}$ load-carrying capacity of steel

Table B. 24 Angle bracket type 5502S, Variant TCP, Fastener GH Screw 5x40, Density 350 kg/m³

Characteristic load-carrying capacity $F_{1,Rk}$ (N) for one / two angle brackets															
angle bracket	1													2	
f (mm)	0	10	20	30	40	50	60	70	80	90	100	110	120	0	
$F_{1,Rk}$	T	4006	945	473	315	236	189	158	135	118	105	95	86	79	8012
	S	28	23	20	18	16	14	13	12	11	10	9	8	8	56
k_1 (-)	9,6	11,5	13,3	15,1	16,9	18,7	20,5	22,4	24,2	26,0	27,8	29,6	31,5	4,8	

Characteristic load-carrying capacity $F_{2/3,Rk}$ (N) for one / two angle brackets			
angle bracket	1	2	
$F_{2/3,Rk}$	T	810	1620
	S	-	-

Characteristic load-carrying capacity $F_{4,Rk}$ (N) for one angle bracket																		
e (mm)	0	20	40	60	80	100	120	140	160	180	200	220	240	260	280	300	320	
$F_{4,Rk}$	T	-	-	2363	394	215	148	113	91	76	66	58	51	46	42	39	36	33
	S	-	74	37	24	18	14	11	9	7	6	5	5	4	4	3	3	3
k_1 (-)	0,0	3,6	7,3	10,9	14,5	18,2	21,8	25,5	29,1	32,7	36,4	40,0	43,6	47,3	50,9	54,5	58,2	

Characteristic load-carrying capacity $F_{5,Rk}$ (N) for one angle bracket																		
b / e (mm)	0	20	40	60	80	100	120	140	160	180	200	220	240	260	280	300	320	
0	T	263	591	3166	2111	1583	1266	1055	905	791	704	633	576	528	487	452	422	396
	S	26	60	323	215	161	129	107	92	80	71	64	58	53	49	46	43	40
20	T	263	591	2003	1335	1002	801	668	572	501	445	401	364	334	308	286	267	250
	S	26	60	323	215	161	129	107	92	80	71	64	58	53	49	46	43	40
40	T	263	591	3166	2111	1583	1266	1055	905	791	704	633	576	528	487	452	422	396
	S	26	60	323	215	161	129	107	92	80	71	64	58	53	49	46	43	40
60	T	263	591	3166	2111	1583	1266	1055	905	791	704	633	576	528	487	452	422	396
	S	26	60	323	215	161	129	107	92	80	71	64	58	53	49	46	43	40
80	T	263	591	3166	2111	1583	1266	1055	905	791	704	633	576	528	487	452	422	396
	S	26	60	323	215	161	129	107	92	80	71	64	58	53	49	46	43	40
100	T	263	591	3166	2111	1583	1266	1055	905	791	704	633	576	528	487	452	422	396
	S	26	60	323	215	161	129	107	92	80	71	64	58	53	49	46	43	40
120	T	263	591	3166	2111	1583	1266	1055	905	791	704	633	576	528	487	452	422	396
	S	26	60	323	215	161	129	107	92	80	71	64	58	53	49	46	43	40
140	T	263	591	3166	2111	1583	1266	1055	905	791	704	633	576	528	487	452	422	396
	S	26	60	323	215	161	129	107	92	80	71	64	58	53	49	46	43	40
160	T	263	591	3166	2111	1583	1266	1055	905	791	704	633	576	528	487	452	422	396
	S	26	60	323	215	161	129	107	92	80	71	64	58	53	49	46	43	40
180	T	263	591	3166	2111	1583	1266	1055	905	791	704	633	576	528	487	452	422	396
	S	26	60	323	215	161	129	107	92	80	71	64	58	53	49	46	43	40
200	T	263	591	3166	2111	1583	1266	1055	905	791	704	633	576	528	487	452	422	396
	S	26	60	323	215	161	129	107	92	80	71	64	58	53	49	46	43	40
220	T	263	591	3166	2111	1583	1266	1055	905	791	704	633	576	528	487	452	422	396
	S	26	60	323	215	161	129	107	92	80	71	64	58	53	49	46	43	40
240	T	263	591	3166	2111	1583	1266	1055	905	791	704	633	576	528	487	452	422	396
	S	26	60	323	215	161	129	107	92	80	71	64	58	53	49	46	43	40
$k_1 \times b$ (-)	0,0	16,7	33,4	50,1	66,8	83,5	100,2	116,9	133,6	150,3	167,0	183,7	200,3	217,0	233,7	250,4	267,1	

Characteristic load-carrying capacity $F_{4/5,Rk}$ (N) for two angle brackets																		
b / e (mm)	0	20	40	60	80	100	120	140	160	180	200	220	240	260	280	300	320	
0	T	7559	7559	7559	7559	7559	7559	7559	7559	7559	7559	7559	7559	7559	7559	7559	7559	
	S	-	-	-	-	-	-	-	-	-	-	-	-	-	-	-	-	
20	T	7559	4006	2003	1335	1002	801	668	572	501	445	401	364	334	308	286	267	250
	S	-	28	14	9	7	5	4	4	3	3	2	2	2	2	2	1	1
40	T	7559	7560	4006	2671	2003	1602	1335	1145	1002	890	801	728	668	616	572	534	501
	S	-	56	28	18	14	11	9	8	7	6	5	5	4	4	4	3	3
60	T	7559	7560	6009	4006	3005	2404	2003	1717	1502	1335	1202	1093	1002	924	858	801	751
	S	-	84	42	28	21	16	14	12	10	9	8	7	7	6	6	5	5
80	T	7559	7560	7560	5341	4006	3205	2671	2289	2003	1780	1602	1457	1335	1233	1145	1068	1002
	S	-	112	56	37	28	22	18	16	14	12	11	10	9	8	8	7	7
100	T	7559	7560	7560	6677	5008	4006	3338	2861	2504	2226	2003	1821	1669	1541	1431	1335	1252
	S	-	141	70	47	35	28	23	20	17	15	14	12	11	10	10	9	8
120	T	7559	7560	7560	7560	6009	4807	4006	3434	3005	2671	2404	2185	2003	1849	1717	1602	1502
	S	-	169	84	56	42	33	28	24	21	18	16	15	14	13	12	11	10
140	T	7559	7560	7560	7560	7011	5608	4674	4006	3505	3116	2804	2549	2337	2157	2003	1869	1753
	S	-	197	98	65	49	39	32	28	24	21	19	17	16	15	14	13	12
160	T	7559	7560	7560	7560	6410	5341	4578	4006	3561	3205	2913	2671	2465	2289	2137	2003	1869
	S	-	225	112	75	56	45	37	32	28	25	22	20	18	17	16	15	14
180	T	7559	7560	7560	7560	7560	7211	6009	5151	4507	4006	3605	3278	3005	2773	2575	2404	2253
	S	-	254	127	84	63	50	42	36	31	28	25	23	21	19	18	16	15
200	T	7559	7560	7560	7560	7560	7560	6677	5723	5008	4451	4006	3642	3338	3082	2861	2671	2504
	S	-	282	141	94	70	56	47	40	35	31	28	25	23	21	20	18	17
220	T	7559	7560	7560	7560	7560	7560	7344	6295	5508	4896	4407	4006	3672	3390	3148	2938	2754
	S	-	310	155	103	77	62	51	44	38	34	31	28	25	23	22	20	19
240	T	7559	7560	7560	7560	7560	7560	7560	6867	6009	5341	4807	4370	4006	3698	3434	3205	3005
	S	-	338	169	112	84	67	56	48	42	37	33	30	28	26	24	22	21
$k_1 \times b$ (-)	0,0	192,7	385,5	578,2	770,9	963,6	1156,4	1349,1	1541,8	1734,5	1927,3	2120,0	2312,7	2505,5	2698,2	2890,9	3083,6	

TTM: Timber-Timber-Maximum | TTP: Timber-Timber-Partial | TCM: Timber-Concrete-Maximum | TCP: Timber-Concrete-Partial

T: $F_{1,T,Rk}$ load-carrying capacity of timber | S: $F_{1,S,Rk}$ load-carrying capacity of steel

Table B. 25 Angle bracket type 5502S, Variant TCP, Fastener GH Screw 5x60, Density 350 kg/m³

Characteristic load-carrying capacity $F_{1,Rk}$ (N) for one / two angle brackets															
angle bracket	1													2	
f (mm)	0	10	20	30	40	50	60	70	80	90	100	110	120	0	
$F_{1,Rk}$	T	4530	1470	735	490	368	294	245	210	184	163	147	134	123	9060
	S	28	23	20	18	16	14	13	12	11	10	9	8	8	56
k_t (-)	9,6	11,5	13,3	15,1	16,9	18,7	20,5	22,4	24,2	26,0	27,8	29,6	31,5	4,8	

Characteristic load-carrying capacity $F_{2/3,Rk}$ (N) for one / two angle brackets		
angle bracket	1	2
$F_{2/3,Rk}$	T	1100
	S	-

Characteristic load-carrying capacity $F_{4,Rk}$ (N) for one angle bracket																	
e (mm)	0	20	40	60	80	100	120	140	160	180	200	220	240	260	280	300	320
$F_{4,Rk}$	T	-	-	3675	613	334	230	175	141	119	102	90	80	72	66	60	56
	S	-	74	37	24	18	14	11	9	7	6	5	5	4	4	3	3
k_t (-)	0,0	3,6	7,3	10,9	14,5	18,2	21,8	25,5	29,1	32,7	36,4	40,0	43,6	47,3	50,9	54,5	58,2

Characteristic load-carrying capacity $F_{5,Rk}$ (N) for one angle bracket																	
b / e (mm)	0	20	40	60	80	100	120	140	160	180	200	220	240	260	280	300	320
0	T	408	919	4925	3283	2462	1970	1642	1407	1231	1094	985	895	821	758	704	657
	S	26	60	323	215	161	129	107	92	80	71	64	58	53	49	46	43
20	T	408	919	2265	1510	1133	906	755	647	566	503	453	412	378	348	324	302
	S	26	60	323	215	161	129	107	92	80	71	64	58	53	49	46	43
40	T	408	919	4530	3020	2265	1812	1510	1294	1133	1007	906	824	755	697	647	604
	S	26	60	323	215	161	129	107	92	80	71	64	58	53	49	46	43
60	T	408	919	4925	3283	2462	1970	1642	1407	1231	1094	985	895	821	758	704	657
	S	26	60	323	215	161	129	107	92	80	71	64	58	53	49	46	43
80	T	408	919	4925	3283	2462	1970	1642	1407	1231	1094	985	895	821	758	704	657
	S	26	60	323	215	161	129	107	92	80	71	64	58	53	49	46	43
100	T	408	919	4925	3283	2462	1970	1642	1407	1231	1094	985	895	821	758	704	657
	S	26	60	323	215	161	129	107	92	80	71	64	58	53	49	46	43
120	T	408	919	4925	3283	2462	1970	1642	1407	1231	1094	985	895	821	758	704	657
	S	26	60	323	215	161	129	107	92	80	71	64	58	53	49	46	43
140	T	408	919	4925	3283	2462	1970	1642	1407	1231	1094	985	895	821	758	704	657
	S	26	60	323	215	161	129	107	92	80	71	64	58	53	49	46	43
160	T	408	919	4925	3283	2462	1970	1642	1407	1231	1094	985	895	821	758	704	657
	S	26	60	323	215	161	129	107	92	80	71	64	58	53	49	46	43
180	T	408	919	4925	3283	2462	1970	1642	1407	1231	1094	985	895	821	758	704	657
	S	26	60	323	215	161	129	107	92	80	71	64	58	53	49	46	43
200	T	408	919	4925	3283	2462	1970	1642	1407	1231	1094	985	895	821	758	704	657
	S	26	60	323	215	161	129	107	92	80	71	64	58	53	49	46	43
220	T	408	919	4925	3283	2462	1970	1642	1407	1231	1094	985	895	821	758	704	657
	S	26	60	323	215	161	129	107	92	80	71	64	58	53	49	46	43
240	T	408	919	4925	3283	2462	1970	1642	1407	1231	1094	985	895	821	758	704	657
	S	26	60	323	215	161	129	107	92	80	71	64	58	53	49	46	43
$k_x \times b$ (-)	0,0	16,7	33,4	50,1	66,8	83,5	100,2	116,9	133,6	150,3	167,0	183,7	200,3	217,0	233,7	250,4	267,1

Characteristic load-carrying capacity $F_{4/5,Rk}$ (N) for two angle brackets																	
b / e (mm)	0	20	40	60	80	100	120	140	160	180	200	220	240	260	280	300	320
0	T	11760	11760	11760	11760	11760	11760	11760	11760	11760	11760	11760	11760	11760	11760	11760	11760
	S	-	-	-	-	-	-	-	-	-	-	-	-	-	-	-	-
20	T	11760	4530	2265	1510	1133	906	755	647	566	503	453	412	378	348	324	302
	S	-	28	14	9	7	5	4	4	3	3	2	2	2	2	2	1
40	T	11760	9060	4530	3020	2265	1812	1510	1294	1133	1007	906	824	755	697	647	604
	S	-	56	28	18	14	11	9	8	7	6	5	5	4	4	4	3
60	T	11760	11760	6795	4530	3398	2718	2265	1941	1699	1510	1359	1235	1133	1045	971	906
	S	-	84	42	28	21	16	14	12	10	9	8	7	7	6	6	5
80	T	11760	11760	9060	6040	4530	3624	3020	2589	2265	2013	1812	1647	1510	1394	1294	1208
	S	-	112	56	37	28	22	18	16	14	12	11	10	9	8	8	7
100	T	11760	11760	11325	7550	5663	4530	3775	3236	2831	2517	2265	2059	1888	1742	1618	1510
	S	-	141	70	47	35	28	23	20	17	15	14	12	11	10	10	9
120	T	11760	11760	11760	9060	6795	5436	4530	3883	3398	3020	2718	2471	2265	2091	1941	1812
	S	-	169	84	56	42	33	28	24	21	18	16	15	14	13	12	11
140	T	11760	11760	11760	10570	7928	6342	5285	4530	3964	3523	3171	2883	2643	2439	2265	2114
	S	-	197	98	65	49	39	32	28	24	21	19	17	16	15	14	13
160	T	11760	11760	11760	11760	9060	7248	6040	5177	4530	4027	3624	3295	3020	2788	2589	2416
	S	-	225	112	75	56	45	37	32	28	25	22	20	18	17	16	15
180	T	11760	11760	11760	11760	10193	8154	6795	5824	5096	4530	4077	3706	3398	3136	2912	2718
	S	-	254	127	84	63	50	42	36	31	28	25	23	21	19	18	16
200	T	11760	11760	11760	11760	11325	9060	7550	6471	5663	5033	4530	4118	3775	3485	3236	3020
	S	-	282	141	94	70	56	47	40	35	31	28	25	23	21	20	18
220	T	11760	11760	11760	11760	11760	9966	8305	7119	6229	5537	4983	4530	4153	3833	3559	3322
	S	-	310	155	103	77	62	51	44	38	34	31	28	25	23	22	20
240	T	11760	11760	11760	11760	11760	10872	9060	7766	6795	6040	5436	4942	4530	4182	3883	3624
	S	-	338	169	112	84	67	56	48	42	37	33	30	28	26	24	22
$k_x \times b$ (-)	0,0	192,7	385,5	578,2	770,9	963,6	1156,4	1349,1	1541,8	1734,5	1927,3	2120,0	2312,7	2505,5	2698,2	2890,9	3083,6

TTM: Timber-Timber-Maximum | TTP: Timber-Timber-Partial | TCM: Timber-Concrete-Maximum | TCP: Timber-Concrete-Partial
T: $F_{1,T,Rk}$ load-carrying capacity of timber | S: $F_{1,S,Rk}$ load-carrying capacity of steel

Table B. 26 Angle bracket type 5502S, Variant TTM, Fastener GH Nail 4x40, Density 350 kg/m³Characteristic load-carrying capacity $F_{T,Rk}$ (N) for one / two angle brackets

angle bracket		1													2
f (mm)		0	10	20	30	40	50	60	70	80	90	100	110	120	0
$F_{T,Rk}$	T	386	245	180	142	113	90	75	64	56	50	45	41	38	771
	S	123	78	48	32	24	19	16	13	12	10	9	8	8	246

Characteristic load-carrying capacity $F_{2/3,Rk}$ (N) for one / two angle brackets

angle bracket		1	2
$F_{2/3,Rk}$	T	3920	7840
	S	-	-

Characteristic load-carrying capacity $F_{4,Rk}$ (N) for one angle bracket

e (mm)		0	20	40	60	80	100	120	140	160	180	200	220	240	260	280	300	320
$F_{4,Rk}$	T	15120	338	169	113	84	68	54	43	36	31	27	24	22	20	18	17	16
	S	-	107	53	35	21	15	11	9	7	6	5	5	4	4	3	3	3

Characteristic load-carrying capacity $F_{5,Rk}$ (N) for one angle bracket

b / e (mm)		0	20	40	60	80	100	120	140	160	180	200	220	240	260	280	300	320
0	T	125	281	1013	675	506	405	338	289	253	225	203	184	169	156	145	135	127
	S	26	60	323	215	161	129	107	92	80	71	64	58	53	49	46	43	40
20	T	125	281	1508	1005	754	603	503	431	377	335	302	274	251	232	215	201	188
	S	26	60	323	215	161	129	107	92	80	71	64	58	53	49	46	43	40
40	T	125	281	1508	1005	754	603	503	431	377	335	302	274	251	232	215	201	188
	S	26	60	323	215	161	129	107	92	80	71	64	58	53	49	46	43	40
60	T	125	281	1508	1005	754	603	503	431	377	335	302	274	251	232	215	201	188
	S	26	60	323	215	161	129	107	92	80	71	64	58	53	49	46	43	40
80	T	125	281	1508	1005	754	603	503	431	377	335	302	274	251	232	215	201	188
	S	26	60	323	215	161	129	107	92	80	71	64	58	53	49	46	43	40
100	T	125	281	1508	1005	754	603	503	431	377	335	302	274	251	232	215	201	188
	S	26	60	323	215	161	129	107	92	80	71	64	58	53	49	46	43	40
120	T	125	281	1508	1005	754	603	503	431	377	335	302	274	251	232	215	201	188
	S	26	60	323	215	161	129	107	92	80	71	64	58	53	49	46	43	40
140	T	125	281	1508	1005	754	603	503	431	377	335	302	274	251	232	215	201	188
	S	26	60	323	215	161	129	107	92	80	71	64	58	53	49	46	43	40
160	T	125	281	1508	1005	754	603	503	431	377	335	302	274	251	232	215	201	188
	S	26	60	323	215	161	129	107	92	80	71	64	58	53	49	46	43	40
180	T	125	281	1508	1005	754	603	503	431	377	335	302	274	251	232	215	201	188
	S	26	60	323	215	161	129	107	92	80	71	64	58	53	49	46	43	40
200	T	125	281	1508	1005	754	603	503	431	377	335	302	274	251	232	215	201	188
	S	26	60	323	215	161	129	107	92	80	71	64	58	53	49	46	43	40
220	T	125	281	1508	1005	754	603	503	431	377	335	302	274	251	232	215	201	188
	S	26	60	323	215	161	129	107	92	80	71	64	58	53	49	46	43	40
240	T	125	281	1508	1005	754	603	503	431	377	335	302	274	251	232	215	201	188
	S	26	60	323	215	161	129	107	92	80	71	64	58	53	49	46	43	40

Characteristic load-carrying capacity $F_{4/5,Rk}$ (N) for two angle brackets

b / e (mm)		0	20	40	60	80	100	120	140	160	180	200	220	240	260	280	300	320
0	T	8999	8999	8999	8999	8999	8999	8999	8999	8999	8999	8999	8999	8999	8999	8999	8999	8999
	S	-	-	-	-	-	-	-	-	-	-	-	-	-	-	-	-	-
20	T	8999	386	193	129	96	77	64	55	48	43	39	35	32	30	28	26	24
	S	-	123	61	41	30	24	20	17	15	13	12	11	10	9	8	8	7
40	T	8999	771	386	257	193	154	129	110	96	86	77	70	64	59	55	51	48
	S	-	246	123	82	61	49	41	35	30	27	24	22	20	18	17	16	15
60	T	8999	1157	579	386	289	231	193	165	145	129	116	105	96	89	83	77	72
	S	-	369	184	123	92	73	61	52	46	41	36	33	30	28	26	24	23
80	T	8999	1543	771	514	386	309	257	220	193	171	154	140	129	119	110	103	96
	S	-	492	246	164	123	98	82	70	61	54	49	44	41	37	35	32	30
100	T	8999	1929	964	643	482	386	321	276	241	214	193	175	161	148	138	129	121
	S	-	615	307	205	153	123	102	87	76	68	61	55	51	47	43	41	38
120	T	8999	2314	1157	771	579	463	386	331	289	257	231	210	193	178	165	154	145
	S	-	738	369	246	184	147	123	105	92	82	73	67	61	56	52	49	46
140	T	8999	2700	1350	900	675	540	450	386	338	300	270	245	225	208	193	180	169
	S	-	861	430	287	215	172	143	123	107	95	86	78	71	66	61	57	53
160	T	8999	3086	1543	1029	771	617	514	441	386	343	309	281	257	237	220	206	193
	S	-	984	492	328	246	196	164	140	123	109	98	89	82	75	70	65	61
180	T	8999	3471	1736	1157	868	694	579	496	434	386	347	316	289	267	248	231	217
	S	-	1107	553	369	276	221	184	158	138	123	110	100	92	85	79	73	69
200	T	8999	3857	1929	1286	964	771	643	551	482	429	386	351	321	297	276	257	241
	S	-	1230	615	410	307	246	205	175	153	136	123	111	102	94	87	82	76
220	T	8999	4243	2121	1414	1061	849	707	606	530	471	424	386	354	326	303	283	265
	S	-	1354	677	451	338	270	225	193	169	150	135	123	112	104	96	90	84
240	T	8999	4629	2314	1543	1157	926	771	661	579	514	463	421	386	356	331	309	289
	S	-	1477	738	492	369	295	246	211	184	164	147	134	123	113	105	98	92

TTM: Timber-Timber-Maximum | TTP: Timber-Timber-Partial | TCM: Timber-Concrete-Maximum | TCP: Timber-Concrete-Partial

T: $F_{T,Rk}$ load-carrying capacity of timber | S: $F_{S,Rk}$ load-carrying capacity of steel

Table B. 27 Angle bracket type 5502S, Variant TTM, Fastener GH Nail 4x60, Density 350 kg/m³Characteristic load-carrying capacity $F_{T,Rk}$ (N) for one / two angle brackets

angle bracket		1													2
f (mm)		0	10	20	30	40	50	60	70	80	90	100	110	120	0
$F_{T,Rk}$	T	643	409	300	237	188	150	125	107	94	83	75	68	63	1286
	S	123	78	48	32	24	19	16	13	12	10	9	8	8	246

Characteristic load-carrying capacity $F_{2/3,Rk}$ (N) for one / two angle brackets

angle bracket		1	2
$F_{2/3,Rk}$	T	5260	10520
	S	-	-

Characteristic load-carrying capacity $F_{4,Rk}$ (N) for one angle bracket

e (mm)		0	20	40	60	80	100	120	140	160	180	200	220	240	260	280	300	320
$F_{4,Rk}$	T	18911	563	281	188	141	113	89	72	60	52	46	41	37	33	31	28	26
	S	-	107	53	35	21	15	11	9	7	6	5	5	4	4	3	3	3

Characteristic load-carrying capacity $F_{5,Rk}$ (N) for one angle bracket

b / e (mm)		0	20	40	60	80	100	120	140	160	180	200	220	240	260	280	300	320
0	T	208	469	1688	1125	844	675	563	482	422	375	338	307	281	260	241	225	211
	S	26	60	323	215	161	129	107	92	80	71	64	58	53	49	46	43	40
20	T	208	469	2513	1675	1256	1005	838	718	628	558	503	457	419	387	359	335	314
	S	26	60	323	215	161	129	107	92	80	71	64	58	53	49	46	43	40
40	T	208	469	2513	1675	1256	1005	838	718	628	558	503	457	419	387	359	335	314
	S	26	60	323	215	161	129	107	92	80	71	64	58	53	49	46	43	40
60	T	208	469	2513	1675	1256	1005	838	718	628	558	503	457	419	387	359	335	314
	S	26	60	323	215	161	129	107	92	80	71	64	58	53	49	46	43	40
80	T	208	469	2513	1675	1256	1005	838	718	628	558	503	457	419	387	359	335	314
	S	26	60	323	215	161	129	107	92	80	71	64	58	53	49	46	43	40
100	T	208	469	2513	1675	1256	1005	838	718	628	558	503	457	419	387	359	335	314
	S	26	60	323	215	161	129	107	92	80	71	64	58	53	49	46	43	40
120	T	208	469	2513	1675	1256	1005	838	718	628	558	503	457	419	387	359	335	314
	S	26	60	323	215	161	129	107	92	80	71	64	58	53	49	46	43	40
140	T	208	469	2513	1675	1256	1005	838	718	628	558	503	457	419	387	359	335	314
	S	26	60	323	215	161	129	107	92	80	71	64	58	53	49	46	43	40
160	T	208	469	2513	1675	1256	1005	838	718	628	558	503	457	419	387	359	335	314
	S	26	60	323	215	161	129	107	92	80	71	64	58	53	49	46	43	40
180	T	208	469	2513	1675	1256	1005	838	718	628	558	503	457	419	387	359	335	314
	S	26	60	323	215	161	129	107	92	80	71	64	58	53	49	46	43	40
200	T	208	469	2513	1675	1256	1005	838	718	628	558	503	457	419	387	359	335	314
	S	26	60	323	215	161	129	107	92	80	71	64	58	53	49	46	43	40
220	T	208	469	2513	1675	1256	1005	838	718	628	558	503	457	419	387	359	335	314
	S	26	60	323	215	161	129	107	92	80	71	64	58	53	49	46	43	40
240	T	208	469	2513	1675	1256	1005	838	718	628	558	503	457	419	387	359	335	314
	S	26	60	323	215	161	129	107	92	80	71	64	58	53	49	46	43	40

Characteristic load-carrying capacity $F_{4/5,Rk}$ (N) for two angle brackets

b / e (mm)		0	20	40	60	80	100	120	140	160	180	200	220	240	260	280	300	320
0	T	15000	15000	15000	15000	15000	15000	15000	15000	15000	15000	15000	15000	15000	15000	15000	15000	15000
	S	-	-	-	-	-	-	-	-	-	-	-	-	-	-	-	-	-
20	T	15000	643	321	214	161	129	107	92	80	71	64	58	54	49	46	43	40
	S	-	123	61	41	30	24	20	17	15	13	12	11	10	9	8	8	7
40	T	15000	1286	643	429	321	257	214	184	161	143	129	117	107	99	92	86	80
	S	-	246	123	82	61	49	41	35	30	27	24	22	20	18	17	16	15
60	T	15000	1929	964	643	482	386	321	276	241	214	193	175	161	148	138	129	121
	S	-	369	184	123	92	73	61	52	46	41	36	33	30	28	26	24	23
80	T	15000	2571	1286	857	643	514	429	367	321	286	257	234	214	198	184	171	161
	S	-	492	246	164	123	98	82	70	61	54	49	44	41	37	35	32	30
100	T	15000	3214	1607	1071	804	643	536	459	402	357	321	292	268	247	230	214	201
	S	-	615	307	205	153	123	102	87	76	68	61	55	51	47	43	41	38
120	T	15000	3857	1929	1286	964	771	643	551	482	429	386	351	321	297	276	257	241
	S	-	738	369	246	184	147	123	105	92	82	73	67	61	56	52	49	46
140	T	15000	4500	2250	1500	1125	900	750	643	563	500	450	409	375	346	321	300	281
	S	-	861	430	287	215	172	143	123	107	95	86	78	71	66	61	57	53
160	T	15000	5143	2571	1714	1286	1029	857	735	643	571	514	468	429	396	367	343	321
	S	-	984	492	328	246	196	164	140	123	109	98	89	82	75	70	65	61
180	T	15000	5786	2893	1929	1446	1157	964	827	723	643	579	526	482	445	413	386	362
	S	-	1107	553	369	276	221	184	158	138	123	110	100	92	85	79	73	69
200	T	15000	6429	3214	2143	1607	1286	1071	918	804	714	643	584	536	495	459	429	402
	S	-	1230	615	410	307	246	205	175	153	136	123	111	102	94	87	82	76
220	T	15000	7071	3536	2357	1768	1414	1179	1010	884	786	707	643	589	544	505	471	442
	S	-	1354	677	451	338	270	225	193	169	150	135	123	112	104	96	90	84
240	T	15000	7714	3857	2571	1929	1543	1286	1102	964	857	771	701	643	593	551	514	482
	S	-	1477	738	492	369	295	246	211	184	164	147	134	123	113	105	98	92

TTM: Timber-Timber-Maximum | TTP: Timber-Timber-Partial | TCM: Timber-Concrete-Maximum | TCP: Timber-Concrete-Partial

T: $F_{T,Rk}$ load-carrying capacity of timber | S: $F_{S,Rk}$ load-carrying capacity of steel

Table B. 28 Angle bracket type 5502S, Variant TTM, Fastener GH Screw 5x40, Density 350 kg/m³Characteristic load-carrying capacity $F_{T,Rk}$ (N) for one / two angle brackets

angle bracket		1													2
f (mm)		0	10	20	30	40	50	60	70	80	90	100	110	120	0
$F_{T,Rk}$	T	810	515	378	298	236	189	158	135	118	105	95	86	79	1620
	S	123	78	48	32	24	19	16	13	12	10	9	8	8	246

Characteristic load-carrying capacity $F_{2/3,Rk}$ (N) for one / two angle brackets

angle bracket		1	2
$F_{2/3,Rk}$	T	4910	9820
	S	-	-

Characteristic load-carrying capacity $F_{4,Rk}$ (N) for one angle bracket

e (mm)		0	20	40	60	80	100	120	140	160	180	200	220	240	260	280	300	320
$F_{4,Rk}$	T	16024	709	354	236	177	142	113	91	76	66	58	51	46	42	39	36	33
	S	-	107	53	35	21	15	11	9	7	6	5	5	4	4	3	3	3

Characteristic load-carrying capacity $F_{5,Rk}$ (N) for one angle bracket

b / e (mm)		0	20	40	60	80	100	120	140	160	180	200	220	240	260	280	300	320
0	T	263	591	2126	1418	1063	851	709	608	532	473	425	387	354	327	304	284	266
	S	26	60	323	215	161	129	107	92	80	71	64	58	53	49	46	43	40
20	T	263	591	3166	2111	1583	1266	1055	905	791	704	633	576	528	487	452	422	396
	S	26	60	323	215	161	129	107	92	80	71	64	58	53	49	46	43	40
40	T	263	591	3166	2111	1583	1266	1055	905	791	704	633	576	528	487	452	422	396
	S	26	60	323	215	161	129	107	92	80	71	64	58	53	49	46	43	40
60	T	263	591	3166	2111	1583	1266	1055	905	791	704	633	576	528	487	452	422	396
	S	26	60	323	215	161	129	107	92	80	71	64	58	53	49	46	43	40
80	T	263	591	3166	2111	1583	1266	1055	905	791	704	633	576	528	487	452	422	396
	S	26	60	323	215	161	129	107	92	80	71	64	58	53	49	46	43	40
100	T	263	591	3166	2111	1583	1266	1055	905	791	704	633	576	528	487	452	422	396
	S	26	60	323	215	161	129	107	92	80	71	64	58	53	49	46	43	40
120	T	263	591	3166	2111	1583	1266	1055	905	791	704	633	576	528	487	452	422	396
	S	26	60	323	215	161	129	107	92	80	71	64	58	53	49	46	43	40
140	T	263	591	3166	2111	1583	1266	1055	905	791	704	633	576	528	487	452	422	396
	S	26	60	323	215	161	129	107	92	80	71	64	58	53	49	46	43	40
160	T	263	591	3166	2111	1583	1266	1055	905	791	704	633	576	528	487	452	422	396
	S	26	60	323	215	161	129	107	92	80	71	64	58	53	49	46	43	40
180	T	263	591	3166	2111	1583	1266	1055	905	791	704	633	576	528	487	452	422	396
	S	26	60	323	215	161	129	107	92	80	71	64	58	53	49	46	43	40
200	T	263	591	3166	2111	1583	1266	1055	905	791	704	633	576	528	487	452	422	396
	S	26	60	323	215	161	129	107	92	80	71	64	58	53	49	46	43	40
220	T	263	591	3166	2111	1583	1266	1055	905	791	704	633	576	528	487	452	422	396
	S	26	60	323	215	161	129	107	92	80	71	64	58	53	49	46	43	40
240	T	263	591	3166	2111	1583	1266	1055	905	791	704	633	576	528	487	452	422	396
	S	26	60	323	215	161	129	107	92	80	71	64	58	53	49	46	43	40

Characteristic load-carrying capacity $F_{4/5,Rk}$ (N) for two angle brackets

b / e (mm)		0	20	40	60	80	100	120	140	160	180	200	220	240	260	280	300	320
0	T	18899	18899	18899	18899	18899	18899	18899	18899	18899	18899	18899	18899	18899	18899	18899	18899	18899
	S	-	-	-	-	-	-	-	-	-	-	-	-	-	-	-	-	-
20	T	18899	810	405	270	203	162	135	116	101	90	81	74	68	62	58	54	51
	S	-	123	61	41	30	24	20	17	15	13	12	11	10	9	8	8	7
40	T	18899	1620	810	540	405	324	270	231	203	180	162	147	135	125	116	108	101
	S	-	246	123	82	61	49	41	35	30	27	24	22	20	18	17	16	15
60	T	18899	2430	1215	810	608	486	405	347	304	270	243	221	203	187	174	162	152
	S	-	369	184	123	92	73	61	52	46	41	36	33	30	28	26	24	23
80	T	18899	3240	1620	1080	810	648	540	463	405	360	324	295	270	249	231	216	203
	S	-	492	246	164	123	98	82	70	61	54	49	44	41	37	35	32	30
100	T	18899	4050	2025	1350	1013	810	675	579	506	450	405	368	338	312	289	270	253
	S	-	615	307	205	153	123	102	87	76	68	61	55	51	47	43	41	38
120	T	18899	4860	2430	1620	1215	972	810	694	608	540	486	442	405	374	347	324	304
	S	-	738	369	246	184	147	123	105	92	82	73	67	61	56	52	49	46
140	T	18899	5670	2835	1890	1418	1134	945	810	709	630	567	515	473	436	405	378	354
	S	-	861	430	287	215	172	143	123	107	95	86	78	71	66	61	57	53
160	T	18899	6480	3240	2160	1620	1296	1080	926	810	720	648	589	540	498	463	432	405
	S	-	984	492	328	246	196	164	140	123	109	98	89	82	75	70	65	61
180	T	18899	7290	3645	2430	1823	1458	1215	1041	911	810	729	663	608	561	521	486	456
	S	-	1107	553	369	276	221	184	158	138	123	110	100	92	85	79	73	69
200	T	18899	8100	4050	2700	2025	1620	1350	1157	1013	900	810	736	675	623	579	540	506
	S	-	1230	615	410	307	246	205	175	153	136	123	111	102	94	87	82	76
220	T	18899	8910	4455	2970	2228	1782	1485	1273	1114	990	891	810	743	685	636	594	557
	S	-	1354	677	451	338	270	225	193	169	150	135	123	112	104	96	90	84
240	T	18899	9720	4860	3240	2430	1944	1620	1389	1215	1080	972	884	810	748	694	648	608
	S	-	1477	738	492	369	295	246	211	184	164	147	134	123	113	105	98	92

TTM: Timber-Timber-Maximum | TTP: Timber-Timber-Partial | TCM: Timber-Concrete-Maximum | TCP: Timber-Concrete-Partial

T: $F_{T,Rk}$ load-carrying capacity of timber | S: $F_{S,Rk}$ load-carrying capacity of steel

Table B. 29 Angle bracket type 5502S, Variant TTM, Fastener GH Screw 5x60, Density 350 kg/m³Characteristic load-carrying capacity $F_{T,Rk}$ (N) for one / two angle brackets

angle bracket		1													2
f (mm)		0	10	20	30	40	50	60	70	80	90	100	110	120	0
$F_{T,Rk}$	T	1260	802	588	464	368	294	245	210	184	163	147	134	123	2520
	S	123	78	48	32	24	19	16	13	12	10	9	8	8	246

Characteristic load-carrying capacity $F_{2/3,Rk}$ (N) for one / two angle brackets

angle bracket		1	2
$F_{2/3,Rk}$	T	5930	11860
	S	-	-

Characteristic load-carrying capacity $F_{4,Rk}$ (N) for one angle bracket

e (mm)		0	20	40	60	80	100	120	140	160	180	200	220	240	260	280	300	320
$F_{4,Rk}$	T	18120	1103	551	368	276	221	175	141	119	102	90	80	72	66	60	56	52
	S	-	107	53	35	21	15	11	9	7	6	5	5	4	4	3	3	3

Characteristic load-carrying capacity $F_{5,Rk}$ (N) for one angle bracket

b / e (mm)		0	20	40	60	80	100	120	140	160	180	200	220	240	260	280	300	320
0	T	408	919	3308	2205	1654	1323	1103	945	827	735	662	601	551	509	473	441	413
	S	26	60	323	215	161	129	107	92	80	71	64	58	53	49	46	43	40
20	T	408	919	4925	3283	2462	1970	1642	1407	1231	1094	985	895	821	758	704	657	616
	S	26	60	323	215	161	129	107	92	80	71	64	58	53	49	46	43	40
40	T	408	919	4925	3283	2462	1970	1642	1407	1231	1094	985	895	821	758	704	657	616
	S	26	60	323	215	161	129	107	92	80	71	64	58	53	49	46	43	40
60	T	408	919	4925	3283	2462	1970	1642	1407	1231	1094	985	895	821	758	704	657	616
	S	26	60	323	215	161	129	107	92	80	71	64	58	53	49	46	43	40
80	T	408	919	4925	3283	2462	1970	1642	1407	1231	1094	985	895	821	758	704	657	616
	S	26	60	323	215	161	129	107	92	80	71	64	58	53	49	46	43	40
100	T	408	919	4925	3283	2462	1970	1642	1407	1231	1094	985	895	821	758	704	657	616
	S	26	60	323	215	161	129	107	92	80	71	64	58	53	49	46	43	40
120	T	408	919	4925	3283	2462	1970	1642	1407	1231	1094	985	895	821	758	704	657	616
	S	26	60	323	215	161	129	107	92	80	71	64	58	53	49	46	43	40
140	T	408	919	4925	3283	2462	1970	1642	1407	1231	1094	985	895	821	758	704	657	616
	S	26	60	323	215	161	129	107	92	80	71	64	58	53	49	46	43	40
160	T	408	919	4925	3283	2462	1970	1642	1407	1231	1094	985	895	821	758	704	657	616
	S	26	60	323	215	161	129	107	92	80	71	64	58	53	49	46	43	40
180	T	408	919	4925	3283	2462	1970	1642	1407	1231	1094	985	895	821	758	704	657	616
	S	26	60	323	215	161	129	107	92	80	71	64	58	53	49	46	43	40
200	T	408	919	4925	3283	2462	1970	1642	1407	1231	1094	985	895	821	758	704	657	616
	S	26	60	323	215	161	129	107	92	80	71	64	58	53	49	46	43	40
220	T	408	919	4925	3283	2462	1970	1642	1407	1231	1094	985	895	821	758	704	657	616
	S	26	60	323	215	161	129	107	92	80	71	64	58	53	49	46	43	40
240	T	408	919	4925	3283	2462	1970	1642	1407	1231	1094	985	895	821	758	704	657	616
	S	26	60	323	215	161	129	107	92	80	71	64	58	53	49	46	43	40

Characteristic load-carrying capacity $F_{4/5,Rk}$ (N) for two angle brackets

b / e (mm)		0	20	40	60	80	100	120	140	160	180	200	220	240	260	280	300	320
0	T	29399	29399	29399	29399	29399	29399	29399	29399	29399	29399	29399	29399	29399	29399	29399	29399	29399
	S	-	-	-	-	-	-	-	-	-	-	-	-	-	-	-	-	-
20	T	29399	1260	630	420	315	252	210	180	158	140	126	115	105	97	90	84	79
	S	-	123	61	41	30	24	20	17	15	13	12	11	10	9	8	8	7
40	T	29399	2520	1260	840	630	504	420	360	315	280	252	229	210	194	180	168	158
	S	-	246	123	82	61	49	41	35	30	27	24	22	20	18	17	16	15
60	T	29399	3780	1890	1260	945	756	630	540	473	420	378	344	315	291	270	252	236
	S	-	369	184	123	92	73	61	52	46	41	36	33	30	28	26	24	23
80	T	29399	5040	2520	1680	1260	1008	840	720	630	560	504	458	420	388	360	336	315
	S	-	492	246	164	123	98	82	70	61	54	49	44	41	37	35	32	30
100	T	29399	6300	3150	2100	1575	1260	1050	900	788	700	630	573	525	485	450	420	394
	S	-	615	307	205	153	123	102	87	76	68	61	55	51	47	43	41	38
120	T	29399	7560	3780	2520	1890	1512	1260	1080	945	840	756	687	630	582	540	504	473
	S	-	738	369	246	184	147	123	105	92	82	73	67	61	56	52	49	46
140	T	29399	8820	4410	2940	2205	1764	1470	1260	1103	980	882	802	735	678	630	588	551
	S	-	861	430	287	215	172	143	123	107	95	86	78	71	66	61	57	53
160	T	29399	10080	5040	3360	2520	2016	1680	1440	1260	1120	1008	916	840	775	720	672	630
	S	-	984	492	328	246	196	164	140	123	109	98	89	82	75	70	65	61
180	T	29399	11340	5670	3780	2835	2268	1890	1620	1418	1260	1134	1031	945	872	810	756	709
	S	-	1107	553	369	276	221	184	158	138	123	110	100	92	85	79	73	69
200	T	29399	12600	6300	4200	3150	2520	2100	1800	1575	1400	1260	1145	1050	969	900	840	788
	S	-	1230	615	410	307	246	205	175	153	136	123	111	102	94	87	82	76
220	T	29399	13860	6930	4620	3465	2772	2310	1980	1733	1540	1386	1260	1155	1066	990	924	866
	S	-	1354	677	451	338	270	225	193	169	150	135	123	112	104	96	90	84
240	T	29399	15120	7560	5040	3780	3024	2520	2160	1890	1680	1512	1375	1260	1163	1080	1008	945
	S	-	1477	738	492	369	295	246	211	184	164	147	134	123	113	105	98	92

TTM: Timber-Timber-Maximum | TTP: Timber-Timber-Partial | TCM: Timber-Concrete-Maximum | TCP: Timber-Concrete-Partial

T: $F_{T,Rk}$ load-carrying capacity of timber | S: $F_{S,Rk}$ load-carrying capacity of steel

Table B. 30 Angle bracket type 5502S, Variant TTP, Fastener GH Nail 4x40, Density 350 kg/m³Characteristic load-carrying capacity $F_{1,Rk}$ (N) for one / two angle brackets

angle bracket		1												2	
f (mm)		0	10	20	30	40	50	60	70	80	90	100	110	120	0
$F_{1,Rk}$	T	386	245	180	142	113	90	75	64	56	50	45	41	38	771
	S	123	78	48	32	24	19	16	13	12	10	9	8	8	246

Characteristic load-carrying capacity $F_{2/3,Rk}$ (N) for one / two angle brackets

angle bracket		1	2
$F_{2/3,Rk}$	T	2210	4420
	S	-	-

Characteristic load-carrying capacity $F_{4,Rk}$ (N) for one angle bracket

e (mm)		0	20	40	60	80	100	120	140	160	180	200	220	240	260	280	300	320
$F_{4,Rk}$	T	5669	338	169	113	84	68	54	43	36	31	27	24	22	20	18	17	16
	S	-	107	53	35	21	15	11	9	7	6	5	5	4	4	3	3	3

Characteristic load-carrying capacity $F_{5,Rk}$ (N) for one angle bracket

b / e (mm)		0	20	40	60	80	100	120	140	160	180	200	220	240	260	280	300	320
0	T	125	281	1013	675	506	405	338	289	253	225	203	184	169	156	145	135	127
	S	26	60	323	215	161	129	107	92	80	71	64	58	53	49	46	43	40
20	T	125	281	1508	1005	754	603	503	431	377	335	302	274	251	232	215	201	188
	S	26	60	323	215	161	129	107	92	80	71	64	58	53	49	46	43	40
40	T	125	281	1508	1005	754	603	503	431	377	335	302	274	251	232	215	201	188
	S	26	60	323	215	161	129	107	92	80	71	64	58	53	49	46	43	40
60	T	125	281	1508	1005	754	603	503	431	377	335	302	274	251	232	215	201	188
	S	26	60	323	215	161	129	107	92	80	71	64	58	53	49	46	43	40
80	T	125	281	1508	1005	754	603	503	431	377	335	302	274	251	232	215	201	188
	S	26	60	323	215	161	129	107	92	80	71	64	58	53	49	46	43	40
100	T	125	281	1508	1005	754	603	503	431	377	335	302	274	251	232	215	201	188
	S	26	60	323	215	161	129	107	92	80	71	64	58	53	49	46	43	40
120	T	125	281	1508	1005	754	603	503	431	377	335	302	274	251	232	215	201	188
	S	26	60	323	215	161	129	107	92	80	71	64	58	53	49	46	43	40
140	T	125	281	1508	1005	754	603	503	431	377	335	302	274	251	232	215	201	188
	S	26	60	323	215	161	129	107	92	80	71	64	58	53	49	46	43	40
160	T	125	281	1508	1005	754	603	503	431	377	335	302	274	251	232	215	201	188
	S	26	60	323	215	161	129	107	92	80	71	64	58	53	49	46	43	40
180	T	125	281	1508	1005	754	603	503	431	377	335	302	274	251	232	215	201	188
	S	26	60	323	215	161	129	107	92	80	71	64	58	53	49	46	43	40
200	T	125	281	1508	1005	754	603	503	431	377	335	302	274	251	232	215	201	188
	S	26	60	323	215	161	129	107	92	80	71	64	58	53	49	46	43	40
220	T	125	281	1508	1005	754	603	503	431	377	335	302	274	251	232	215	201	188
	S	26	60	323	215	161	129	107	92	80	71	64	58	53	49	46	43	40
240	T	125	281	1508	1005	754	603	503	431	377	335	302	274	251	232	215	201	188
	S	26	60	323	215	161	129	107	92	80	71	64	58	53	49	46	43	40

Characteristic load-carrying capacity $F_{4/5,Rk}$ (N) for two angle brackets

b / e (mm)		0	20	40	60	80	100	120	140	160	180	200	220	240	260	280	300	320
0	T	3600	3600	3600	3600	3600	3600	3600	3600	3600	3600	3600	3600	3600	3600	3600	3600	3600
	S	-	-	-	-	-	-	-	-	-	-	-	-	-	-	-	-	-
20	T	3600	386	193	129	96	77	64	55	48	43	39	35	32	30	28	26	24
	S	-	123	61	41	30	24	20	17	15	13	12	11	10	9	8	8	7
40	T	3600	771	386	257	193	154	129	110	96	86	77	70	64	59	55	51	48
	S	-	246	123	82	61	49	41	35	30	27	24	22	20	18	17	16	15
60	T	3600	1157	579	386	289	231	193	165	145	129	116	105	96	89	83	77	72
	S	-	369	184	123	92	73	61	52	46	41	36	33	30	28	26	24	23
80	T	3600	1543	771	514	386	309	257	220	193	171	154	140	129	119	110	103	96
	S	-	492	246	164	123	98	82	70	61	54	49	44	41	37	35	32	30
100	T	3600	1929	964	643	482	386	321	276	241	214	193	175	161	148	138	129	121
	S	-	615	307	205	153	123	102	87	76	68	61	55	51	47	43	41	38
120	T	3600	2314	1157	771	579	463	386	331	289	257	231	210	193	178	165	154	145
	S	-	738	369	246	184	147	123	105	92	82	73	67	61	56	52	49	46
140	T	3600	2700	1350	900	675	540	450	386	338	300	270	245	225	208	193	180	169
	S	-	861	430	287	215	172	143	123	107	95	86	78	71	66	61	57	53
160	T	3600	3086	1543	1029	771	617	514	441	386	343	309	281	257	237	220	206	193
	S	-	984	492	328	246	196	164	140	123	109	98	89	82	75	70	65	61
180	T	3600	3471	1736	1157	868	694	579	496	434	386	347	316	289	267	248	231	217
	S	-	1107	553	369	276	221	184	158	138	123	110	100	92	85	79	73	69
200	T	3600	3600	1929	1286	964	771	643	551	482	429	386	351	321	297	276	257	241
	S	-	1230	615	410	307	246	205	175	153	136	123	111	102	94	87	82	76
220	T	3600	3600	2121	1414	1061	849	707	606	530	471	424	386	354	326	303	283	265
	S	-	1354	677	451	338	270	225	193	169	150	135	123	112	104	96	90	84
240	T	3600	3600	2314	1543	1157	926	771	661	579	514	463	421	386	356	331	309	289
	S	-	1477	738	492	369	295	246	211	184	164	147	134	123	113	105	98	92

TTM: Timber-Timber-Maximum | TTP: Timber-Timber-Partial | TCM: Timber-Concrete-Maximum | TCP: Timber-Concrete-Partial

T: $F_{1,T,Rk}$ load-carrying capacity of timber | S: $F_{1,S,Rk}$ load-carrying capacity of steel

Table B. 31 Angle bracket type 5502S, Variant TTP, Fastener GH Nail 4x60, Density 350 kg/m³Characteristic load-carrying capacity $F_{T,Rk}$ (N) for one / two angle brackets

angle bracket		1													2
f (mm)		0	10	20	30	40	50	60	70	80	90	100	110	120	0
$F_{T,Rk}$	T	643	409	300	237	188	150	125	107	94	83	75	68	63	1286
	S	123	78	48	32	24	19	16	13	12	10	9	8	8	246

Characteristic load-carrying capacity $F_{2/3,Rk}$ (N) for one / two angle brackets

angle bracket		1	2
$F_{2/3,Rk}$	T	3040	6080
	S	-	-

Characteristic load-carrying capacity $F_{4,Rk}$ (N) for one angle bracket

e (mm)		0	20	40	60	80	100	120	140	160	180	200	220	240	260	280	300	320
$F_{4,Rk}$	T	7091	563	281	188	141	113	89	72	60	52	46	41	37	33	31	28	26
	S	-	107	53	35	21	15	11	9	7	6	5	5	4	4	3	3	3

Characteristic load-carrying capacity $F_{5,Rk}$ (N) for one angle bracket

b / e (mm)		0	20	40	60	80	100	120	140	160	180	200	220	240	260	280	300	320
0	T	208	469	1688	1125	844	675	563	482	422	375	338	307	281	260	241	225	211
	S	26	60	323	215	161	129	107	92	80	71	64	58	53	49	46	43	40
20	T	208	469	2364	1576	1182	946	788	675	591	525	473	430	394	364	338	315	296
	S	26	60	323	215	161	129	107	92	80	71	64	58	53	49	46	43	40
40	T	208	469	2513	1675	1256	1005	838	718	628	558	503	457	419	387	359	335	314
	S	26	60	323	215	161	129	107	92	80	71	64	58	53	49	46	43	40
60	T	208	469	2513	1675	1256	1005	838	718	628	558	503	457	419	387	359	335	314
	S	26	60	323	215	161	129	107	92	80	71	64	58	53	49	46	43	40
80	T	208	469	2513	1675	1256	1005	838	718	628	558	503	457	419	387	359	335	314
	S	26	60	323	215	161	129	107	92	80	71	64	58	53	49	46	43	40
100	T	208	469	2513	1675	1256	1005	838	718	628	558	503	457	419	387	359	335	314
	S	26	60	323	215	161	129	107	92	80	71	64	58	53	49	46	43	40
120	T	208	469	2513	1675	1256	1005	838	718	628	558	503	457	419	387	359	335	314
	S	26	60	323	215	161	129	107	92	80	71	64	58	53	49	46	43	40
140	T	208	469	2513	1675	1256	1005	838	718	628	558	503	457	419	387	359	335	314
	S	26	60	323	215	161	129	107	92	80	71	64	58	53	49	46	43	40
160	T	208	469	2513	1675	1256	1005	838	718	628	558	503	457	419	387	359	335	314
	S	26	60	323	215	161	129	107	92	80	71	64	58	53	49	46	43	40
180	T	208	469	2513	1675	1256	1005	838	718	628	558	503	457	419	387	359	335	314
	S	26	60	323	215	161	129	107	92	80	71	64	58	53	49	46	43	40
200	T	208	469	2513	1675	1256	1005	838	718	628	558	503	457	419	387	359	335	314
	S	26	60	323	215	161	129	107	92	80	71	64	58	53	49	46	43	40
220	T	208	469	2513	1675	1256	1005	838	718	628	558	503	457	419	387	359	335	314
	S	26	60	323	215	161	129	107	92	80	71	64	58	53	49	46	43	40
240	T	208	469	2513	1675	1256	1005	838	718	628	558	503	457	419	387	359	335	314
	S	26	60	323	215	161	129	107	92	80	71	64	58	53	49	46	43	40

Characteristic load-carrying capacity $F_{4/5,Rk}$ (N) for two angle brackets

b / e (mm)		0	20	40	60	80	100	120	140	160	180	200	220	240	260	280	300	320
0	T	5999	5999	5999	5999	5999	5999	5999	5999	5999	5999	5999	5999	5999	5999	5999	5999	5999
	S	-	-	-	-	-	-	-	-	-	-	-	-	-	-	-	-	-
20	T	5999	643	321	214	161	129	107	92	80	71	64	58	54	49	46	43	40
	S	-	123	61	41	30	24	20	17	15	13	12	11	10	9	8	8	7
40	T	5999	1286	643	429	321	257	214	184	161	143	129	117	107	99	92	86	80
	S	-	246	123	82	61	49	41	35	30	27	24	22	20	18	17	16	15
60	T	5999	1929	964	643	482	386	321	276	241	214	193	175	161	148	138	129	121
	S	-	369	184	123	92	73	61	52	46	41	36	33	30	28	26	24	23
80	T	5999	2571	1286	857	643	514	429	367	321	286	257	234	214	198	184	171	161
	S	-	492	246	164	123	98	82	70	61	54	49	44	41	37	35	32	30
100	T	5999	3214	1607	1071	804	643	536	459	402	357	321	292	268	247	230	214	201
	S	-	615	307	205	153	123	102	87	76	68	61	55	51	47	43	41	38
120	T	5999	3857	1929	1286	964	771	643	551	482	429	386	351	321	297	276	257	241
	S	-	738	369	246	184	147	123	105	92	82	73	67	61	56	52	49	46
140	T	5999	4500	2250	1500	1125	900	750	643	563	500	450	409	375	346	321	300	281
	S	-	861	430	287	215	172	143	123	107	95	86	78	71	66	61	57	53
160	T	5999	5143	2571	1714	1286	1029	857	735	643	571	514	468	429	396	367	343	321
	S	-	984	492	328	246	196	164	140	123	109	98	89	82	75	70	65	61
180	T	5999	5786	2893	1929	1446	1157	964	827	723	643	579	526	482	445	413	386	362
	S	-	1107	553	369	276	221	184	158	138	123	110	100	92	85	79	73	69
200	T	5999	6000	3214	2143	1607	1286	1071	918	804	714	643	584	536	495	459	429	402
	S	-	1230	615	410	307	246	205	175	153	136	123	111	102	94	87	82	76
220	T	5999	6000	3536	2357	1768	1414	1179	1010	884	786	707	643	589	544	505	471	442
	S	-	1354	677	451	338	270	225	193	169	150	135	123	112	104	96	90	84
240	T	5999	6000	3857	2571	1929	1543	1286	1102	964	857	771	701	643	593	551	514	482
	S	-	1477	738	492	369	295	246	211	184	164	147	134	123	113	105	98	92

TTM: Timber-Timber-Maximum | TTP: Timber-Timber-Partial | TCM: Timber-Concrete-Maximum | TCP: Timber-Concrete-Partial

T: $F_{T,Rk}$ load-carrying capacity of timber | S: $F_{S,Rk}$ load-carrying capacity of steel

Table B. 32 Angle bracket type 5502S, Variant TTP, Fastener GH Screw 5x40, Density 350 kg/m³Characteristic load-carrying capacity $F_{T,Rk}$ (N) for one / two angle brackets

angle bracket		1													2
f (mm)		0	10	20	30	40	50	60	70	80	90	100	110	120	0
$F_{T,Rk}$	T	810	515	378	298	236	189	158	135	118	105	95	86	79	1620
	S	123	78	48	32	24	19	16	13	12	10	9	8	8	246

Characteristic load-carrying capacity $F_{2/3,Rk}$ (N) for one / two angle brackets

angle bracket		1	2
$F_{2/3,Rk}$	T	2930	5860
	S	-	-

Characteristic load-carrying capacity $F_{4,Rk}$ (N) for one angle bracket

e (mm)		0	20	40	60	80	100	120	140	160	180	200	220	240	260	280	300	320
$F_{4,Rk}$	T	6008	709	354	236	177	142	113	91	76	66	58	51	46	42	39	36	33
	S	-	107	53	35	21	15	11	9	7	6	5	5	4	4	3	3	3

Characteristic load-carrying capacity $F_{5,Rk}$ (N) for one angle bracket

b / e (mm)		0	20	40	60	80	100	120	140	160	180	200	220	240	260	280	300	320
0	T	263	591	2126	1418	1063	851	709	608	532	473	425	387	354	327	304	284	266
	S	26	60	323	215	161	129	107	92	80	71	64	58	53	49	46	43	40
20	T	263	591	2003	1335	1002	801	668	572	501	445	401	364	334	308	286	267	250
	S	26	60	323	215	161	129	107	92	80	71	64	58	53	49	46	43	40
40	T	263	591	3166	2111	1583	1266	1055	905	791	704	633	576	528	487	452	422	396
	S	26	60	323	215	161	129	107	92	80	71	64	58	53	49	46	43	40
60	T	263	591	3166	2111	1583	1266	1055	905	791	704	633	576	528	487	452	422	396
	S	26	60	323	215	161	129	107	92	80	71	64	58	53	49	46	43	40
80	T	263	591	3166	2111	1583	1266	1055	905	791	704	633	576	528	487	452	422	396
	S	26	60	323	215	161	129	107	92	80	71	64	58	53	49	46	43	40
100	T	263	591	3166	2111	1583	1266	1055	905	791	704	633	576	528	487	452	422	396
	S	26	60	323	215	161	129	107	92	80	71	64	58	53	49	46	43	40
120	T	263	591	3166	2111	1583	1266	1055	905	791	704	633	576	528	487	452	422	396
	S	26	60	323	215	161	129	107	92	80	71	64	58	53	49	46	43	40
140	T	263	591	3166	2111	1583	1266	1055	905	791	704	633	576	528	487	452	422	396
	S	26	60	323	215	161	129	107	92	80	71	64	58	53	49	46	43	40
160	T	263	591	3166	2111	1583	1266	1055	905	791	704	633	576	528	487	452	422	396
	S	26	60	323	215	161	129	107	92	80	71	64	58	53	49	46	43	40
180	T	263	591	3166	2111	1583	1266	1055	905	791	704	633	576	528	487	452	422	396
	S	26	60	323	215	161	129	107	92	80	71	64	58	53	49	46	43	40
200	T	263	591	3166	2111	1583	1266	1055	905	791	704	633	576	528	487	452	422	396
	S	26	60	323	215	161	129	107	92	80	71	64	58	53	49	46	43	40
220	T	263	591	3166	2111	1583	1266	1055	905	791	704	633	576	528	487	452	422	396
	S	26	60	323	215	161	129	107	92	80	71	64	58	53	49	46	43	40
240	T	263	591	3166	2111	1583	1266	1055	905	791	704	633	576	528	487	452	422	396
	S	26	60	323	215	161	129	107	92	80	71	64	58	53	49	46	43	40

Characteristic load-carrying capacity $F_{4/5,Rk}$ (N) for two angle brackets

b / e (mm)		0	20	40	60	80	100	120	140	160	180	200	220	240	260	280	300	320
0	T	7559	7559	7559	7559	7559	7559	7559	7559	7559	7559	7559	7559	7559	7559	7559	7559	7559
	S	-	-	-	-	-	-	-	-	-	-	-	-	-	-	-	-	-
20	T	7559	810	405	270	203	162	135	116	101	90	81	74	68	62	58	54	51
	S	-	123	61	41	30	24	20	17	15	13	12	11	10	9	8	8	7
40	T	7559	1620	810	540	405	324	270	231	203	180	162	147	135	125	116	108	101
	S	-	246	123	82	61	49	41	35	30	27	24	22	20	18	17	16	15
60	T	7559	2430	1215	810	608	486	405	347	304	270	243	221	203	187	174	162	152
	S	-	369	184	123	92	73	61	52	46	41	36	33	30	28	26	24	23
80	T	7559	3240	1620	1080	810	648	540	463	405	360	324	295	270	249	231	216	203
	S	-	492	246	164	123	98	82	70	61	54	49	44	41	37	35	32	30
100	T	7559	4050	2025	1350	1013	810	675	579	506	450	405	368	338	312	289	270	253
	S	-	615	307	205	153	123	102	87	76	68	61	55	51	47	43	41	38
120	T	7559	4860	2430	1620	1215	972	810	694	608	540	486	442	405	374	347	324	304
	S	-	738	369	246	184	147	123	105	92	82	73	67	61	56	52	49	46
140	T	7559	5670	2835	1890	1418	1134	945	810	709	630	567	515	473	436	405	378	354
	S	-	861	430	287	215	172	143	123	107	95	86	78	71	66	61	57	53
160	T	7559	6480	3240	2160	1620	1296	1080	926	810	720	648	589	540	498	463	432	405
	S	-	984	492	328	246	196	164	140	123	109	98	89	82	75	70	65	61
180	T	7559	7290	3645	2430	1823	1458	1215	1041	911	810	729	663	608	561	521	486	456
	S	-	1107	553	369	276	221	184	158	138	123	110	100	92	85	79	73	69
200	T	7559	7560	4050	2700	2025	1620	1350	1157	1013	900	810	736	675	623	579	540	506
	S	-	1230	615	410	307	246	205	175	153	136	123	111	102	94	87	82	76
220	T	7559	7560	4455	2970	2228	1782	1485	1273	1114	990	891	810	743	685	636	594	557
	S	-	1354	677	451	338	270	225	193	169	150	135	123	112	104	96	90	84
240	T	7559	7560	4860	3240	2430	1944	1620	1389	1215	1080	972	884	810	748	694	648	608
	S	-	1477	738	492	369	295	246	211	184	164	147	134	123	113	105	98	92

TTM: Timber-Timber-Maximum | TTP: Timber-Timber-Partial | TCM: Timber-Concrete-Maximum | TCP: Timber-Concrete-Partial

T: $F_{T,Rk}$ load-carrying capacity of timber | S: $F_{S,Rk}$ load-carrying capacity of steel

Table B. 33 Angle bracket type 5502S, Variant TTP, Fastener GH Screw 5x60, Density 350 kg/m³Characteristic load-carrying capacity $F_{1,Rk}$ (N) for one / two angle brackets

angle bracket		1													2
f (mm)		0	10	20	30	40	50	60	70	80	90	100	110	120	0
$F_{1,Rk}$	T	1260	802	588	464	368	294	245	210	184	163	147	134	123	2520
	S	123	78	48	32	24	19	16	13	12	10	9	8	8	246

Characteristic load-carrying capacity $F_{2/3,Rk}$ (N) for one / two angle brackets

angle bracket		1	2
$F_{2/3,Rk}$	T	3610	7220
	S	-	-

Characteristic load-carrying capacity $F_{4,Rk}$ (N) for one angle bracket

e (mm)		0	20	40	60	80	100	120	140	160	180	200	220	240	260	280	300	320
$F_{4,Rk}$	T	6794	1103	551	368	276	221	175	141	119	102	90	80	72	66	60	56	52
	S	-	107	53	35	21	15	11	9	7	6	5	5	4	4	3	3	3

Characteristic load-carrying capacity $F_{5,Rk}$ (N) for one angle bracket

b / e (mm)		0	20	40	60	80	100	120	140	160	180	200	220	240	260	280	300	320
0	T	408	919	3308	2205	1654	1323	1103	945	827	735	662	601	551	509	473	441	413
	S	26	60	323	215	161	129	107	92	80	71	64	58	53	49	46	43	40
20	T	408	919	2265	1510	1133	906	755	647	566	503	453	412	378	348	324	302	283
	S	26	60	323	215	161	129	107	92	80	71	64	58	53	49	46	43	40
40	T	408	919	4530	3020	2265	1812	1510	1294	1133	1007	906	824	755	697	647	604	566
	S	26	60	323	215	161	129	107	92	80	71	64	58	53	49	46	43	40
60	T	408	919	4925	3283	2462	1970	1642	1407	1231	1094	985	895	821	758	704	657	616
	S	26	60	323	215	161	129	107	92	80	71	64	58	53	49	46	43	40
80	T	408	919	4925	3283	2462	1970	1642	1407	1231	1094	985	895	821	758	704	657	616
	S	26	60	323	215	161	129	107	92	80	71	64	58	53	49	46	43	40
100	T	408	919	4925	3283	2462	1970	1642	1407	1231	1094	985	895	821	758	704	657	616
	S	26	60	323	215	161	129	107	92	80	71	64	58	53	49	46	43	40
120	T	408	919	4925	3283	2462	1970	1642	1407	1231	1094	985	895	821	758	704	657	616
	S	26	60	323	215	161	129	107	92	80	71	64	58	53	49	46	43	40
140	T	408	919	4925	3283	2462	1970	1642	1407	1231	1094	985	895	821	758	704	657	616
	S	26	60	323	215	161	129	107	92	80	71	64	58	53	49	46	43	40
160	T	408	919	4925	3283	2462	1970	1642	1407	1231	1094	985	895	821	758	704	657	616
	S	26	60	323	215	161	129	107	92	80	71	64	58	53	49	46	43	40
180	T	408	919	4925	3283	2462	1970	1642	1407	1231	1094	985	895	821	758	704	657	616
	S	26	60	323	215	161	129	107	92	80	71	64	58	53	49	46	43	40
200	T	408	919	4925	3283	2462	1970	1642	1407	1231	1094	985	895	821	758	704	657	616
	S	26	60	323	215	161	129	107	92	80	71	64	58	53	49	46	43	40
220	T	408	919	4925	3283	2462	1970	1642	1407	1231	1094	985	895	821	758	704	657	616
	S	26	60	323	215	161	129	107	92	80	71	64	58	53	49	46	43	40
240	T	408	919	4925	3283	2462	1970	1642	1407	1231	1094	985	895	821	758	704	657	616
	S	26	60	323	215	161	129	107	92	80	71	64	58	53	49	46	43	40

Characteristic load-carrying capacity $F_{4/5,Rk}$ (N) for two angle brackets

b / e (mm)		0	20	40	60	80	100	120	140	160	180	200	220	240	260	280	300	320
0	T	11760	11760	11760	11760	11760	11760	11760	11760	11760	11760	11760	11760	11760	11760	11760	11760	11760
	S	-	-	-	-	-	-	-	-	-	-	-	-	-	-	-	-	-
20	T	11760	1260	630	420	315	252	210	180	158	140	126	115	105	97	90	84	79
	S	-	123	61	41	30	24	20	17	15	13	12	11	10	9	8	8	7
40	T	11760	2520	1260	840	630	504	420	360	315	280	252	229	210	194	180	168	158
	S	-	246	123	82	61	49	41	35	30	27	24	22	20	18	17	16	15
60	T	11760	3780	1890	1260	945	756	630	540	473	420	378	344	315	291	270	252	236
	S	-	369	184	123	92	73	61	52	46	41	36	33	30	28	26	24	23
80	T	11760	5040	2520	1680	1260	1008	840	720	630	560	504	458	420	388	360	336	315
	S	-	492	246	164	123	98	82	70	61	54	49	44	41	37	35	32	30
100	T	11760	6300	3150	2100	1575	1260	1050	900	788	700	630	573	525	485	450	420	394
	S	-	615	307	205	153	123	102	87	76	68	61	55	51	47	43	41	38
120	T	11760	7560	3780	2520	1890	1512	1260	1080	945	840	756	687	630	582	540	504	473
	S	-	738	369	246	184	147	123	105	92	82	73	67	61	56	52	49	46
140	T	11760	8820	4410	2940	2205	1764	1470	1260	1103	980	882	802	735	678	630	588	551
	S	-	861	430	287	215	172	143	123	107	95	86	78	71	66	61	57	53
160	T	11760	10080	5040	3360	2520	2016	1680	1440	1260	1120	1008	916	840	775	720	672	630
	S	-	984	492	328	246	196	164	140	123	109	98	89	82	75	70	65	61
180	T	11760	11340	5670	3780	2835	2268	1890	1620	1418	1260	1134	1031	945	872	810	756	709
	S	-	1107	553	369	276	221	184	158	138	123	110	100	92	85	79	73	69
200	T	11760	11760	6300	4200	3150	2520	2100	1800	1575	1400	1260	1145	1050	969	900	840	788
	S	-	1230	615	410	307	246	205	175	153	136	123	111	102	94	87	82	76
220	T	11760	11760	6930	4620	3465	2772	2310	1980	1733	1540	1386	1260	1155	1066	990	924	866
	S	-	1354	677	451	338	270	225	193	169	150	135	123	112	104	96	90	84
240	T	11760	11760	7560	5040	3780	3024	2520	2160	1890	1680	1512	1375	1260	1163	1080	1008	945
	S	-	1477	738	492	369	295	246	211	184	164	147	134	123	113	105	98	92

TTM: Timber-Timber-Maximum | TTP: Timber-Timber-Partial | TCM: Timber-Concrete-Maximum | TCP: Timber-Concrete-Partial

T: $F_{1,T,Rk}$ load-carrying capacity of timber | S: $F_{1,S,Rk}$ load-carrying capacity of steel

Table B. 34 Angle bracket type 6503S, Variant TCM, Fastener GH Nail 4x40, Density 350 kg/m³Characteristic load-carrying capacity $F_{1,Rk}$ (N) for one / two angle brackets

angle bracket		1													2
f (mm)		0	10	20	30	40	50	60	70	80	90	100	110	120	0
$F_{1,Rk}$	T	15120	4886	2443	1629	1221	977	814	698	611	543	489	444	407	30240
	S	21	19	17	15	14	13	12	11	10	10	9	9	8	42
k_t (-)		14,6	16,5	18,3	20,1	21,9	23,7	25,5	27,4	29,2	31,0	32,8	34,6	36,5	7,3

Characteristic load-carrying capacity $F_{2/3,Rk}$ (N) for one / two angle brackets

angle bracket		1	2
$F_{2/3,Rk}$	T	1760	3520
	S	-	-

Characteristic load-carrying capacity $F_{4,Rk}$ (N) for one angle bracket

e (mm)		0	20	40	60	80	100	120	140	160	180	200	220	240	260	280	300	320
$F_{4,Rk}$	T	-	-	-	13959	2079	1123	769	585	472	396	340	299	266	240	219	201	185
	S	-	88	44	29	22	17	14	12	11	9	8	8	7	6	6	5	5
k_t (-)		0,0	3,6	7,3	10,9	14,5	18,2	21,8	25,5	29,1	32,7	36,4	40,0	43,6	47,3	50,9	54,5	58,2

Characteristic load-carrying capacity $F_{5,Rk}$ (N) for one angle bracket

b / e (mm)		0	20	40	60	80	100	120	140	160	180	200	220	240	260	280	300	320
0	T	865	1339	2961	2194	1645	1316	1097	940	823	731	658	598	548	506	470	439	411
	S	165	256	566	400	300	240	200	171	150	133	120	109	100	92	85	80	75
20	T	865	1339	2961	2194	1645	1316	1097	940	823	731	658	598	548	506	470	439	411
	S	165	256	566	400	300	240	200	171	150	133	120	109	100	92	85	80	75
40	T	865	1339	2961	2194	1645	1316	1097	940	823	731	658	598	548	506	470	439	411
	S	165	256	566	400	300	240	200	171	150	133	120	109	100	92	85	80	75
60	T	865	1339	2961	2194	1645	1316	1097	940	823	731	658	598	548	506	470	439	411
	S	165	256	566	400	300	240	200	171	150	133	120	109	100	92	85	80	75
80	T	865	1339	2961	2194	1645	1316	1097	940	823	731	658	598	548	506	470	439	411
	S	165	256	566	400	300	240	200	171	150	133	120	109	100	92	85	80	75
100	T	865	1339	2961	2194	1645	1316	1097	940	823	731	658	598	548	506	470	439	411
	S	165	256	566	400	300	240	200	171	150	133	120	109	100	92	85	80	75
120	T	865	1339	2961	2194	1645	1316	1097	940	823	731	658	598	548	506	470	439	411
	S	165	256	566	400	300	240	200	171	150	133	120	109	100	92	85	80	75
140	T	865	1339	2961	2194	1645	1316	1097	940	823	731	658	598	548	506	470	439	411
	S	165	256	566	400	300	240	200	171	150	133	120	109	100	92	85	80	75
160	T	865	1339	2961	2194	1645	1316	1097	940	823	731	658	598	548	506	470	439	411
	S	165	256	566	400	300	240	200	171	150	133	120	109	100	92	85	80	75
180	T	865	1339	2961	2194	1645	1316	1097	940	823	731	658	598	548	506	470	439	411
	S	165	256	566	400	300	240	200	171	150	133	120	109	100	92	85	80	75
200	T	865	1339	2961	2194	1645	1316	1097	940	823	731	658	598	548	506	470	439	411
	S	165	256	566	400	300	240	200	171	150	133	120	109	100	92	85	80	75
220	T	865	1339	2961	2194	1645	1316	1097	940	823	731	658	598	548	506	470	439	411
	S	165	256	566	400	300	240	200	171	150	133	120	109	100	92	85	80	75
240	T	865	1339	2961	2194	1645	1316	1097	940	823	731	658	598	548	506	470	439	411
	S	165	256	566	400	300	240	200	171	150	133	120	109	100	92	85	80	75
$k_t \times b$ (-)		0,0	15,2	30,5	45,7	61,0	76,2	91,4	106,7	121,9	137,1	152,4	167,6	182,9	198,1	213,3	228,6	243,8

Characteristic load-carrying capacity $F_{4/5,Rk}$ (N) for two angle brackets

b / e (mm)		0	20	40	60	80	100	120	140	160	180	200	220	240	260	280	300	320
0	T	14400	14400	14400	14400	14400	14400	14400	14400	14400	14400	14400	14400	14400	14400	14400	14400	14400
	S	-	-	-	-	-	-	-	-	-	-	-	-	-	-	-	-	-
20	T	14400	14400	7560	5040	3780	3024	2520	2160	1890	1680	1512	1375	1260	1163	1080	1008	945
	S	-	21	10	7	5	4	3	3	2	2	2	1	1	1	1	1	1
40	T	14400	14400	14400	10080	7560	6048	5040	4320	3780	3360	3024	2749	2520	2326	2160	2016	1890
	S	-	43	21	14	10	8	7	6	5	4	4	3	3	3	3	2	2
60	T	14400	14400	14400	14400	11340	9072	7560	6480	5670	5040	4536	4124	3780	3489	3240	3024	2835
	S	-	65	32	21	16	13	10	9	8	7	6	5	5	5	4	4	4
80	T	14400	14400	14400	14400	14400	12096	10080	8640	7560	6720	6048	5498	5040	4652	4320	4032	3780
	S	-	87	43	29	21	17	14	12	10	9	8	7	7	6	6	5	5
100	T	14400	14400	14400	14400	14400	12600	10800	9450	8400	7560	6873	6300	5815	5400	5040	4725	4425
	S	-	109	54	36	27	21	18	15	13	12	10	9	9	8	7	7	6
120	T	14400	14400	14400	14400	14400	14400	12960	11340	10080	9072	8247	7560	6978	6480	6048	5670	5310
	S	-	131	65	43	32	26	21	18	16	14	13	11	10	10	9	8	8
140	T	14400	14400	14400	14400	14400	14400	14400	13230	11760	10584	9622	8820	8142	7560	7056	6615	6225
	S	-	153	76	51	38	30	25	21	19	17	15	13	12	11	10	10	9
160	T	14400	14400	14400	14400	14400	14400	14400	14400	13440	12096	10996	10080	9305	8640	8064	7560	7125
	S	-	174	87	58	43	34	29	24	21	19	17	15	14	13	12	11	10
180	T	14400	14400	14400	14400	14400	14400	14400	14400	14400	14400	13608	12371	11340	10468	9720	9072	8505
	S	-	196	98	65	49	39	32	28	24	21	19	17	16	15	14	13	12
200	T	14400	14400	14400	14400	14400	14400	14400	14400	14400	14400	14400	13745	12600	11631	10800	10080	9450
	S	-	218	109	72	54	43	36	31	27	24	21	19	18	16	15	14	13
220	T	14400	14400	14400	14400	14400	14400	14400	14400	14400	14400	14400	14400	13860	12794	11880	11088	10395
	S	-	240	120	80	60	48	40	34	30	26	24	21	20	18	17	16	15
240	T	14400	14400	14400	14400	14400	14400	14400	14400	14400	14400	14400	14400	14400	13957	12960	12096	11340
	S	-	262	131	87	65	52	43	37	32	29	26	23	21	20	18	17	16
$k_t \times b$ (-)		0,0	292,7	585,5	878,2	1170,9	1463,6	1756,4	2049,1	2341,8	2634,5	2927,3	3220,0	3512,7	3805,5	4098,2	4390,9	4683,6

TTM: Timber-Timber-Maximum | TTP: Timber-Timber-Partial | TCM: Timber-Concrete-Maximum | TCP: Timber-Concrete-Partial

T: $F_{1,T,Rk}$ load-carrying capacity of timber | S: $F_{1,S,Rk}$ load-carrying capacity of steel

Table B. 35 Angle bracket type 6503S, Variant TCM, Fastener GH Nail 4x60, Density 350 kg/m³

Characteristic load-carrying capacity $F_{1,Rk}$ (N) for one / two angle brackets																		
angle bracket	1														2			
f (mm)	0	10	20	30	40	50	60	70	80	90	100	110	120	0				
$F_{1,Rk}$	T	18912	8143	4071	2714	2036	1629	1357	1163	1018	905	814	740	679	37824			
	S	21	19	17	15	14	13	12	11	10	10	9	9	8	42			
k_1 (-)	14,6	16,5	18,3	20,1	21,9	23,7	25,5	27,4	29,2	31,0	32,8	34,6	36,5	7,3				
Characteristic load-carrying capacity $F_{2/3,Rk}$ (N) for one / two angle brackets																		
angle bracket	1	2																
$F_{2/3,Rk}$	T	2760	5520															
	S	-	-															
Characteristic load-carrying capacity $F_{4,Rk}$ (N) for one angle bracket																		
e (mm)	0	20	40	60	80	100	120	140	160	180	200	220	240	260	280	300	320	
$F_{4,Rk}$	T	-	-	-	23265	3465	1872	1282	975	787	659	567	498	444	400	364	334	309
	S	-	88	44	29	22	17	14	12	11	9	8	8	7	6	6	5	5
k_1 (-)	0,0	3,6	7,3	10,9	14,5	18,2	21,8	25,5	29,1	32,7	36,4	40,0	43,6	47,3	50,9	54,5	58,2	
Characteristic load-carrying capacity $F_{5,Rk}$ (N) for one angle bracket																		
b / e (mm)	0	20	40	60	80	100	120	140	160	180	200	220	240	260	280	300	320	
0	T	1441	2231	4935	3656	2742	2194	1828	1567	1371	1219	1097	997	914	844	783	731	686
	S	165	256	566	400	300	240	200	171	150	133	120	109	100	92	85	80	75
20	T	1441	2231	4935	3656	2742	2194	1828	1567	1371	1219	1097	997	914	844	783	731	686
	S	165	256	566	400	300	240	200	171	150	133	120	109	100	92	85	80	75
40	T	1441	2231	4935	3656	2742	2194	1828	1567	1371	1219	1097	997	914	844	783	731	686
	S	165	256	566	400	300	240	200	171	150	133	120	109	100	92	85	80	75
60	T	1441	2231	4935	3656	2742	2194	1828	1567	1371	1219	1097	997	914	844	783	731	686
	S	165	256	566	400	300	240	200	171	150	133	120	109	100	92	85	80	75
80	T	1441	2231	4935	3656	2742	2194	1828	1567	1371	1219	1097	997	914	844	783	731	686
	S	165	256	566	400	300	240	200	171	150	133	120	109	100	92	85	80	75
100	T	1441	2231	4935	3656	2742	2194	1828	1567	1371	1219	1097	997	914	844	783	731	686
	S	165	256	566	400	300	240	200	171	150	133	120	109	100	92	85	80	75
120	T	1441	2231	4935	3656	2742	2194	1828	1567	1371	1219	1097	997	914	844	783	731	686
	S	165	256	566	400	300	240	200	171	150	133	120	109	100	92	85	80	75
140	T	1441	2231	4935	3656	2742	2194	1828	1567	1371	1219	1097	997	914	844	783	731	686
	S	165	256	566	400	300	240	200	171	150	133	120	109	100	92	85	80	75
160	T	1441	2231	4935	3656	2742	2194	1828	1567	1371	1219	1097	997	914	844	783	731	686
	S	165	256	566	400	300	240	200	171	150	133	120	109	100	92	85	80	75
180	T	1441	2231	4935	3656	2742	2194	1828	1567	1371	1219	1097	997	914	844	783	731	686
	S	165	256	566	400	300	240	200	171	150	133	120	109	100	92	85	80	75
200	T	1441	2231	4935	3656	2742	2194	1828	1567	1371	1219	1097	997	914	844	783	731	686
	S	165	256	566	400	300	240	200	171	150	133	120	109	100	92	85	80	75
220	T	1441	2231	4935	3656	2742	2194	1828	1567	1371	1219	1097	997	914	844	783	731	686
	S	165	256	566	400	300	240	200	171	150	133	120	109	100	92	85	80	75
240	T	1441	2231	4935	3656	2742	2194	1828	1567	1371	1219	1097	997	914	844	783	731	686
	S	165	256	566	400	300	240	200	171	150	133	120	109	100	92	85	80	75
$k_1 \times b$ (-)	0,0	15,2	30,5	45,7	61,0	76,2	91,4	106,7	121,9	137,1	152,4	167,6	182,9	198,1	213,3	228,6	243,8	
Characteristic load-carrying capacity $F_{4/5,Rk}$ (N) for two angle brackets																		
b / e (mm)	0	20	40	60	80	100	120	140	160	180	200	220	240	260	280	300	320	
0	T	23999	23999	23999	23999	23999	23999	23999	23999	23999	23999	23999	23999	23999	23999	23999	23999	
	S	-	-	-	-	-	-	-	-	-	-	-	-	-	-	-	-	
20	T	23999	18912	9456	6304	4728	3782	3152	2702	2364	2101	1891	1719	1576	1455	1351	1261	1182
	S	-	21	10	7	5	4	3	3	2	2	2	1	1	1	1	1	1
40	T	23999	24000	18912	12608	9456	7565	6304	5403	4728	4203	3782	3439	3152	2910	2702	2522	2364
	S	-	43	21	14	10	8	7	6	5	4	4	3	3	3	3	2	2
60	T	23999	24000	24000	18912	14184	11347	9456	8105	7092	6304	5674	5158	4728	4364	4053	3782	3546
	S	-	65	32	21	16	13	10	9	8	7	6	5	5	5	4	4	4
80	T	23999	24000	24000	24000	18912	15130	12608	10807	9456	8405	7565	6877	6304	5819	5403	5043	4728
	S	-	87	43	29	21	17	14	12	10	9	8	7	7	6	6	5	5
100	T	23999	24000	24000	24000	23640	18912	15760	13509	11820	10507	9456	8596	7880	7274	6754	6304	5910
	S	-	109	54	36	27	21	18	15	13	12	10	9	9	8	7	7	6
120	T	23999	24000	24000	24000	24000	22694	18912	16210	14184	12608	11347	10316	9456	8729	8105	7565	7092
	S	-	131	65	43	32	26	21	18	16	14	13	11	10	10	9	8	8
140	T	23999	24000	24000	24000	24000	22064	18912	16548	14709	13238	12035	11032	10183	9456	8826	8274	
	S	-	153	76	51	38	30	25	21	19	17	15	13	12	11	10	10	9
160	T	23999	24000	24000	24000	24000	24000	21614	18912	16811	15130	13754	12608	11638	10807	10086	9456	
	S	-	174	87	58	43	34	29	24	21	19	17	15	14	13	12	11	10
180	T	23999	24000	24000	24000	24000	24000	24000	21276	18912	17021	15473	14184	13093	12158	11347	10638	
	S	-	196	98	65	49	39	32	28	24	21	19	17	16	15	14	13	12
200	T	23999	24000	24000	24000	24000	24000	24000	23640	21013	18912	17193	15760	14548	13509	12608	11820	
	S	-	218	109	72	54	43	36	31	27	24	21	19	18	16	15	14	13
220	T	23999	24000	24000	24000	24000	24000	24000	24000	23115	20803	18912	17336	16002	14859	13869	13002	
	S	-	240	120	80	60	48	40	34	30	26	24	21	20	18	17	16	15
240	T	23999	24000	24000	24000	24000	24000	24000	24000	24000	24000	22694	20631	18912	17457	16210	15130	14184
	S	-	262	131	87	65	52	43	37	32	29	26	23	21	20	18	17	16
$k_1 \times b$ (-)	0,0	292,7	585,5	878,2	1170,9	1463,6	1756,4	2049,1	2341,8	2634,5	2927,3	3220,0	3512,7	3805,5	4098,2	4390,9	4683,6	

TTM: Timber-Timber-Maximum | TTP: Timber-Timber-Partial | TCM: Timber-Concrete-Maximum | TCP: Timber-Concrete-Partial

T: $F_{1,T,Rk}$ load-carrying capacity of timber | S: $F_{1,S,Rk}$ load-carrying capacity of steel

Table B. 36 Angle bracket type 6503S, Variant TCM, Fastener GH Screw 5x40, Density 350 kg/m³Characteristic load-carrying capacity $F_{T,Rk}$ (N) for one / two angle brackets

angle bracket		1													2
f (mm)		0	10	20	30	40	50	60	70	80	90	100	110	120	0
$F_{T,Rk}$	T	16024	10260	5130	3420	2565	2052	1710	1466	1283	1140	1026	933	855	32048
	S	21	19	17	15	14	13	12	11	10	10	9	9	8	42
$k_t (-)$		14,6	16,5	18,3	20,1	21,9	23,7	25,5	27,4	29,2	31,0	32,8	34,6	36,5	7,3

Characteristic load-carrying capacity $F_{2/3,Rk}$ (N) for one / two angle brackets

angle bracket		1	2
$F_{2/3,Rk}$	T	3020	6040
	S	-	-

Characteristic load-carrying capacity $F_{4,Rk}$ (N) for one angle bracket

e (mm)		0	20	40	60	80	100	120	140	160	180	200	220	240	260	280	300	320
$F_{4,Rk}$	T	-	-	-	29314	4366	2359	1616	1229	991	831	715	628	559	504	459	421	389
	S	-	88	44	29	22	17	14	12	11	9	8	8	7	6	6	5	5
$k_t (-)$		0,0	3,6	7,3	10,9	14,5	18,2	21,8	25,5	29,1	32,7	36,4	40,0	43,6	47,3	50,9	54,5	58,2

Characteristic load-carrying capacity $F_{5,Rk}$ (N) for one angle bracket

b / e (mm)		0	20	40	60	80	100	120	140	160	180	200	220	240	260	280	300	320
0	T	1816	2811	6218	4607	3455	2764	2303	1974	1727	1536	1382	1256	1152	1063	987	921	864
	S	165	256	566	400	300	240	200	171	150	133	120	109	100	92	85	80	75
20	T	1816	2811	6218	4607	3455	2764	2303	1974	1727	1536	1382	1256	1152	1063	987	921	864
	S	165	256	566	400	300	240	200	171	150	133	120	109	100	92	85	80	75
40	T	1816	2811	6218	4607	3455	2764	2303	1974	1727	1536	1382	1256	1152	1063	987	921	864
	S	165	256	566	400	300	240	200	171	150	133	120	109	100	92	85	80	75
60	T	1816	2811	6218	4607	3455	2764	2303	1974	1727	1536	1382	1256	1152	1063	987	921	864
	S	165	256	566	400	300	240	200	171	150	133	120	109	100	92	85	80	75
80	T	1816	2811	6218	4607	3455	2764	2303	1974	1727	1536	1382	1256	1152	1063	987	921	864
	S	165	256	566	400	300	240	200	171	150	133	120	109	100	92	85	80	75
100	T	1816	2811	6218	4607	3455	2764	2303	1974	1727	1536	1382	1256	1152	1063	987	921	864
	S	165	256	566	400	300	240	200	171	150	133	120	109	100	92	85	80	75
120	T	1816	2811	6218	4607	3455	2764	2303	1974	1727	1536	1382	1256	1152	1063	987	921	864
	S	165	256	566	400	300	240	200	171	150	133	120	109	100	92	85	80	75
140	T	1816	2811	6218	4607	3455	2764	2303	1974	1727	1536	1382	1256	1152	1063	987	921	864
	S	165	256	566	400	300	240	200	171	150	133	120	109	100	92	85	80	75
160	T	1816	2811	6218	4607	3455	2764	2303	1974	1727	1536	1382	1256	1152	1063	987	921	864
	S	165	256	566	400	300	240	200	171	150	133	120	109	100	92	85	80	75
180	T	1816	2811	6218	4607	3455	2764	2303	1974	1727	1536	1382	1256	1152	1063	987	921	864
	S	165	256	566	400	300	240	200	171	150	133	120	109	100	92	85	80	75
200	T	1816	2811	6218	4607	3455	2764	2303	1974	1727	1536	1382	1256	1152	1063	987	921	864
	S	165	256	566	400	300	240	200	171	150	133	120	109	100	92	85	80	75
220	T	1816	2811	6218	4607	3455	2764	2303	1974	1727	1536	1382	1256	1152	1063	987	921	864
	S	165	256	566	400	300	240	200	171	150	133	120	109	100	92	85	80	75
240	T	1816	2811	6218	4607	3455	2764	2303	1974	1727	1536	1382	1256	1152	1063	987	921	864
	S	165	256	566	400	300	240	200	171	150	133	120	109	100	92	85	80	75
$k_t \times b (-)$		0,0	15,2	30,5	45,7	61,0	76,2	91,4	106,7	121,9	137,1	152,4	167,6	182,9	198,1	213,3	228,6	243,8

Characteristic load-carrying capacity $F_{4/5,Rk}$ (N) for two angle brackets

b / e (mm)		0	20	40	60	80	100	120	140	160	180	200	220	240	260	280	300	320
0	T	30239	30239	30239	30239	30239	30239	30239	30239	30239	30239	30239	30239	30239	30239	30239	30239	30239
	S	-	-	-	-	-	-	-	-	-	-	-	-	-	-	-	-	-
20	T	30239	16024	8012	5341	4006	3205	2671	2289	2003	1780	1602	1457	1335	1233	1145	1068	1002
	S	-	21	10	7	5	4	3	3	2	2	2	1	1	1	1	1	1
40	T	30239	30240	16024	10683	8012	6410	5341	4578	4006	3561	3205	2913	2671	2465	2289	2137	2003
	S	-	43	21	14	10	8	7	6	5	4	4	3	3	3	3	2	2
60	T	30239	30240	24036	16024	12018	9614	8012	6867	6009	5341	4807	4370	4006	3698	3434	3205	3005
	S	-	65	32	21	16	13	10	9	8	7	6	5	5	5	4	4	4
80	T	30239	30240	30240	21365	16024	12819	10683	9157	8012	7122	6410	5827	5341	4930	4578	4273	4006
	S	-	87	43	29	21	17	14	12	10	9	8	7	7	6	6	5	5
100	T	30239	30240	30240	26707	20030	16024	13353	11446	10015	8902	8012	7284	6677	6163	5723	5341	5008
	S	-	109	54	36	27	21	18	15	13	12	10	9	9	8	7	7	6
120	T	30239	30240	30240	30240	24036	19229	16024	13735	12018	10683	9614	8740	8012	7396	6867	6410	6009
	S	-	131	65	43	32	26	21	18	16	14	13	11	10	10	9	8	8
140	T	30239	30240	30240	30240	28042	22434	18695	16024	14021	12463	11217	10197	9347	8628	8012	7478	7011
	S	-	153	76	51	38	30	25	21	19	17	15	13	12	11	10	10	9
160	T	30239	30240	30240	30240	30240	25638	21365	18313	16024	14244	12819	11654	10683	9861	9157	8546	8012
	S	-	174	87	58	43	34	29	24	21	19	17	15	14	13	12	11	10
180	T	30239	30240	30240	30240	30240	28843	24036	20602	18027	16024	14422	13111	12018	11094	10301	9614	9014
	S	-	196	98	65	49	39	32	28	24	21	19	17	16	15	14	13	12
200	T	30239	30240	30240	30240	30240	26707	22891	20030	17804	16024	14567	13353	12326	11446	10683	10015	10015
	S	-	218	109	72	54	43	36	31	27	24	21	19	18	16	15	14	13
220	T	30239	30240	30240	30240	30240	29377	25181	22033	19585	17626	16024	14689	13559	12590	11751	11017	11017
	S	-	240	120	80	60	48	40	34	30	26	24	21	20	18	17	16	15
240	T	30239	30240	30240	30240	30240	30240	27470	24036	21365	19229	17481	16024	14791	13735	12819	12018	12018
	S	-	262	131	87	65	52	43	37	32	29	26	23	21	20	18	17	16
$k_t \times b (-)$		0,0	292,7	585,5	878,2	1170,9	1463,6	1756,4	2049,1	2341,8	2634,5	2927,3	3220,0	3512,7	3805,5	4098,2	4390,9	4683,6

TTM: Timber-Timber-Maximum | TTP: Timber-Timber-Partial | TCM: Timber-Concrete-Maximum | TCP: Timber-Concrete-Partial

T: $F_{T,Rk}$ load-carrying capacity of timber | S: $F_{S,Rk}$ load-carrying capacity of steel

Table B. 37 Angle bracket type 6503S, Variant TCM, Fastener GH Screw 5x60, Density 350 kg/m³Characteristic load-carrying capacity $F_{T,Rk}$ (N) for one / two angle brackets

angle bracket	1													2	
f (mm)	0	10	20	30	40	50	60	70	80	90	100	110	120	0	
$F_{T,Rk}$	T	18120	15960	7980	5320	3990	3192	2660	2280	1995	1773	1596	1451	1330	36240
	S	21	19	17	15	14	13	12	11	10	10	9	9	8	42
k_t (-)	14,6	16,5	18,3	20,1	21,9	23,7	25,5	27,4	29,2	31,0	32,8	34,6	36,5	7,3	

Characteristic load-carrying capacity $F_{2/3,Rk}$ (N) for one / two angle brackets

angle bracket	1	2	
$F_{2/3,Rk}$	T	3960	7920
	S	-	-

Characteristic load-carrying capacity $F_{4,Rk}$ (N) for one angle bracket

e (mm)	0	20	40	60	80	100	120	140	160	180	200	220	240	260	280	300	320	
$F_{4,Rk}$	T	-	-	-	45600	6791	3669	2513	1911	1542	1292	1112	976	870	784	714	655	606
	S	-	88	44	29	22	17	14	12	11	9	8	8	7	6	6	5	5
k_t (-)	0,0	3,6	7,3	10,9	14,5	18,2	21,8	25,5	29,1	32,7	36,4	40,0	43,6	47,3	50,9	54,5	58,2	

Characteristic load-carrying capacity $F_{5,Rk}$ (N) for one angle bracket

b / e (mm)	0	20	40	60	80	100	120	140	160	180	200	220	240	260	280	300	320	
0	T	2825	4373	9673	7166	5374	4299	3583	3071	2687	2389	2150	1954	1791	1654	1536	1433	1344
	S	165	256	566	400	300	240	200	171	150	133	120	109	100	92	85	80	75
20	T	2825	4373	9673	6040	4530	3624	3020	2589	2265	2013	1812	1647	1510	1394	1294	1208	1133
	S	165	256	566	400	300	240	200	171	150	133	120	109	100	92	85	80	75
40	T	2825	4373	9673	7166	5374	4299	3583	3071	2687	2389	2150	1954	1791	1654	1536	1433	1344
	S	165	256	566	400	300	240	200	171	150	133	120	109	100	92	85	80	75
60	T	2825	4373	9673	7166	5374	4299	3583	3071	2687	2389	2150	1954	1791	1654	1536	1433	1344
	S	165	256	566	400	300	240	200	171	150	133	120	109	100	92	85	80	75
80	T	2825	4373	9673	7166	5374	4299	3583	3071	2687	2389	2150	1954	1791	1654	1536	1433	1344
	S	165	256	566	400	300	240	200	171	150	133	120	109	100	92	85	80	75
100	T	2825	4373	9673	7166	5374	4299	3583	3071	2687	2389	2150	1954	1791	1654	1536	1433	1344
	S	165	256	566	400	300	240	200	171	150	133	120	109	100	92	85	80	75
120	T	2825	4373	9673	7166	5374	4299	3583	3071	2687	2389	2150	1954	1791	1654	1536	1433	1344
	S	165	256	566	400	300	240	200	171	150	133	120	109	100	92	85	80	75
140	T	2825	4373	9673	7166	5374	4299	3583	3071	2687	2389	2150	1954	1791	1654	1536	1433	1344
	S	165	256	566	400	300	240	200	171	150	133	120	109	100	92	85	80	75
160	T	2825	4373	9673	7166	5374	4299	3583	3071	2687	2389	2150	1954	1791	1654	1536	1433	1344
	S	165	256	566	400	300	240	200	171	150	133	120	109	100	92	85	80	75
180	T	2825	4373	9673	7166	5374	4299	3583	3071	2687	2389	2150	1954	1791	1654	1536	1433	1344
	S	165	256	566	400	300	240	200	171	150	133	120	109	100	92	85	80	75
200	T	2825	4373	9673	7166	5374	4299	3583	3071	2687	2389	2150	1954	1791	1654	1536	1433	1344
	S	165	256	566	400	300	240	200	171	150	133	120	109	100	92	85	80	75
220	T	2825	4373	9673	7166	5374	4299	3583	3071	2687	2389	2150	1954	1791	1654	1536	1433	1344
	S	165	256	566	400	300	240	200	171	150	133	120	109	100	92	85	80	75
240	T	2825	4373	9673	7166	5374	4299	3583	3071	2687	2389	2150	1954	1791	1654	1536	1433	1344
	S	165	256	566	400	300	240	200	171	150	133	120	109	100	92	85	80	75
$k_t \times b$ (-)	0,0	15,2	30,5	45,7	61,0	76,2	91,4	106,7	121,9	137,1	152,4	167,6	182,9	198,1	213,3	228,6	243,8	

Characteristic load-carrying capacity $F_{4/5,Rk}$ (N) for two angle brackets

b / e (mm)	0	20	40	60	80	100	120	140	160	180	200	220	240	260	280	300	320	
0	T	47040	47040	47040	47040	47040	47040	47040	47040	47040	47040	47040	47040	47040	47040	47040	47040	
	S	-	-	-	-	-	-	-	-	-	-	-	-	-	-	-	-	
20	T	47040	18120	9060	6040	4530	3624	3020	2589	2265	2013	1812	1647	1510	1394	1294	1208	1133
	S	-	21	10	7	5	4	3	3	2	2	2	1	1	1	1	1	1
40	T	47040	36240	18120	12080	9060	7248	6040	5177	4530	4027	3624	3295	3020	2788	2589	2416	2265
	S	-	43	21	14	10	8	7	6	5	4	4	3	3	3	3	2	2
60	T	47040	47040	27180	18120	13590	10872	9060	7766	6795	6040	5436	4942	4530	4182	3883	3624	3398
	S	-	65	32	21	16	13	10	9	8	7	6	5	5	5	4	4	4
80	T	47040	47040	36240	24160	18120	14496	12080	10354	9060	8053	7248	6589	6040	5575	5177	4832	4530
	S	-	87	43	29	21	17	14	12	10	9	8	7	7	6	6	5	5
100	T	47040	47040	45300	30200	22650	18120	15100	12943	11325	10067	9060	8236	7550	6969	6471	6040	5663
	S	-	109	54	36	27	21	18	15	13	12	10	9	9	8	7	7	6
120	T	47040	47040	47040	36240	27180	21744	18120	15531	13590	12080	10872	9884	9060	8363	7766	7248	6795
	S	-	131	65	43	32	26	21	18	16	14	13	11	10	10	9	8	8
140	T	47040	47040	47040	42280	31710	25368	21140	18120	15855	14093	12684	11531	10570	9757	9060	8456	7928
	S	-	153	76	51	38	30	25	21	19	17	15	13	12	11	10	10	9
160	T	47040	47040	47040	47040	36240	28992	24160	20709	18120	16107	14496	13178	12080	11151	10354	9664	9060
	S	-	174	87	58	43	34	29	24	21	19	17	15	14	13	12	11	10
180	T	47040	47040	47040	47040	40770	32616	27180	23297	20385	18120	16308	14825	13590	12545	11649	10872	10193
	S	-	196	98	65	49	39	32	28	24	21	19	17	16	15	14	13	12
200	T	47040	47040	47040	47040	45300	36240	30200	25886	22650	20133	18120	16473	15100	13938	12943	12080	11325
	S	-	218	109	72	54	43	36	31	27	24	21	19	18	16	15	14	13
220	T	47040	47040	47040	47040	47040	39864	33220	28474	24915	22147	19932	18120	16610	15332	14237	13288	12458
	S	-	240	120	80	60	48	40	34	30	26	24	21	20	18	17	16	15
240	T	47040	47040	47040	47040	47040	43488	36240	31063	27180	24160	21744	19767	18120	16726	15531	14496	13590
	S	-	262	131	87	65	52	43	37	32	29	26	23	21	20	18	17	16
$k_t \times b$ (-)	0,0	292,7	585,5	878,2	1170,9	1463,6	1756,4	2049,1	2341,8	2634,5	2927,3	3220,0	3512,7	3805,5	4098,2	4390,9	4683,6	

TTM: Timber-Timber-Maximum | TTP: Timber-Timber-Partial | TCM: Timber-Concrete-Maximum | TCP: Timber-Concrete-Partial

T: $F_{T,Rk}$ load-carrying capacity of timber | S: $F_{S,Rk}$ load-carrying capacity of steel

Table B. 38 Angle bracket type 6503S, Variant TCP, Fastener GH Nail 4x40, Density 350 kg/m³Characteristic load-carrying capacity $F_{1,Rk}$ (N) for one / two angle brackets

angle bracket		1												2	
f (mm)		0	10	20	30	40	50	60	70	80	90	100	110	120	0
$F_{1,Rk}$	T	7560	4050	2025	1350	1013	810	675	579	506	450	405	368	338	15120
	S	21	19	17	15	14	13	12	11	10	10	9	9	8	42
k_t (-)		14,6	16,5	18,3	20,1	21,9	23,7	25,5	27,4	29,2	31,0	32,8	34,6	36,5	7,3

Characteristic load-carrying capacity $F_{2/3,Rk}$ (N) for one / two angle brackets

angle bracket		1	2
$F_{2/3,Rk}$	T	920	1840
	S	-	-

Characteristic load-carrying capacity $F_{4,Rk}$ (N) for one angle bracket

e (mm)		0	20	40	60	80	100	120	140	160	180	200	220	240	260	280	300	320
$F_{4,Rk}$	T	-	-	-	11571	1723	931	638	485	391	328	282	248	221	199	181	166	154
	S	-	88	44	29	22	17	14	12	11	9	8	8	7	6	6	5	5
k_t (-)		0,0	3,6	7,3	10,9	14,5	18,2	21,8	25,5	29,1	32,7	36,4	40,0	43,6	47,3	50,9	54,5	58,2

Characteristic load-carrying capacity $F_{5,Rk}$ (N) for one angle bracket

b / e (mm)		0	20	40	60	80	100	120	140	160	180	200	220	240	260	280	300	320
0	T	717	1110	2455	1020	765	612	510	437	383	340	306	278	255	235	219	204	191
	S	281	435	600	400	300	240	200	171	150	133	120	109	100	92	85	80	75
20	T	717	1110	2455	1020	765	612	510	437	383	340	306	278	255	235	219	204	191
	S	281	435	600	400	300	240	200	171	150	133	120	109	100	92	85	80	75
40	T	717	1110	2455	1020	765	612	510	437	383	340	306	278	255	235	219	204	191
	S	281	435	600	400	300	240	200	171	150	133	120	109	100	92	85	80	75
60	T	717	1110	2455	1020	765	612	510	437	383	340	306	278	255	235	219	204	191
	S	281	435	600	400	300	240	200	171	150	133	120	109	100	92	85	80	75
80	T	717	1110	2455	1020	765	612	510	437	383	340	306	278	255	235	219	204	191
	S	281	435	600	400	300	240	200	171	150	133	120	109	100	92	85	80	75
100	T	717	1110	2455	1020	765	612	510	437	383	340	306	278	255	235	219	204	191
	S	281	435	600	400	300	240	200	171	150	133	120	109	100	92	85	80	75
120	T	717	1110	2455	1020	765	612	510	437	383	340	306	278	255	235	219	204	191
	S	281	435	600	400	300	240	200	171	150	133	120	109	100	92	85	80	75
140	T	717	1110	2455	1020	765	612	510	437	383	340	306	278	255	235	219	204	191
	S	281	435	600	400	300	240	200	171	150	133	120	109	100	92	85	80	75
160	T	717	1110	2455	1020	765	612	510	437	383	340	306	278	255	235	219	204	191
	S	281	435	600	400	300	240	200	171	150	133	120	109	100	92	85	80	75
180	T	717	1110	2455	1020	765	612	510	437	383	340	306	278	255	235	219	204	191
	S	281	435	600	400	300	240	200	171	150	133	120	109	100	92	85	80	75
200	T	717	1110	2455	1020	765	612	510	437	383	340	306	278	255	235	219	204	191
	S	281	435	600	400	300	240	200	171	150	133	120	109	100	92	85	80	75
220	T	717	1110	2455	1020	765	612	510	437	383	340	306	278	255	235	219	204	191
	S	281	435	600	400	300	240	200	171	150	133	120	109	100	92	85	80	75
240	T	717	1110	2455	1020	765	612	510	437	383	340	306	278	255	235	219	204	191
	S	281	435	600	400	300	240	200	171	150	133	120	109	100	92	85	80	75
$k_t \times b$ (-)		0,0	15,2	30,5	45,7	61,0	76,2	91,4	106,7	121,9	137,1	152,4	167,6	182,9	198,1	213,3	228,6	243,8

Characteristic load-carrying capacity $F_{4/5,Rk}$ (N) for two angle brackets

b / e (mm)		0	20	40	60	80	100	120	140	160	180	200	220	240	260	280	300	320
0	T	7199	7199	7199	7199	7199	7199	7199	7199	7199	7199	7199	7199	7199	7199	7199	7199	7199
	S	-	-	-	-	-	-	-	-	-	-	-	-	-	-	-	-	-
20	T	7199	7200	3780	2520	1890	1512	1260	1080	945	840	756	687	630	582	540	504	473
	S	-	21	10	7	5	4	3	3	2	2	2	1	1	1	1	1	1
40	T	7199	7200	7200	5040	3780	3024	2520	2160	1890	1680	1512	1375	1260	1163	1080	1008	945
	S	-	43	21	14	10	8	7	6	5	4	4	3	3	3	3	2	2
60	T	7199	7200	7200	7200	5670	4536	3780	3240	2835	2520	2268	2062	1890	1745	1620	1512	1418
	S	-	65	32	21	16	13	10	9	8	7	6	5	5	4	4	4	4
80	T	7199	7200	7200	7200	7200	6048	5040	4320	3780	3360	3024	2749	2520	2326	2160	2016	1890
	S	-	87	43	29	21	17	14	12	10	9	8	7	7	6	6	5	5
100	T	7199	7200	7200	7200	7200	6300	5400	4725	4200	3780	3436	3150	2908	2700	2520	2363	2363
	S	-	109	54	36	27	21	18	15	13	12	10	9	8	7	7	6	6
120	T	7199	7200	7200	7200	7200	7200	7200	6480	5670	5040	4536	4124	3780	3489	3240	3024	2835
	S	-	131	65	43	32	26	21	18	16	14	13	11	10	10	9	8	8
140	T	7199	7200	7200	7200	7200	7200	7200	7200	6615	5880	5292	4811	4410	4071	3780	3528	3308
	S	-	153	76	51	38	30	25	21	19	17	15	13	12	11	10	10	9
160	T	7199	7200	7200	7200	7200	7200	7200	7200	6720	6048	5498	5040	4652	4320	4032	3780	3780
	S	-	174	87	58	43	34	29	24	21	19	17	15	14	13	12	11	10
180	T	7199	7200	7200	7200	7200	7200	7200	7200	7200	7200	6804	6185	5670	5234	4860	4536	4253
	S	-	196	98	65	49	39	32	28	24	21	19	17	16	15	14	13	12
200	T	7199	7200	7200	7200	7200	7200	7200	7200	7200	7200	7200	6873	6300	5815	5400	5040	4725
	S	-	218	109	72	54	43	36	31	27	24	21	19	18	16	15	14	13
220	T	7199	7200	7200	7200	7200	7200	7200	7200	7200	7200	7200	7200	6930	6397	5940	5544	5198
	S	-	240	120	80	60	48	40	34	30	26	24	21	20	18	17	16	15
240	T	7199	7200	7200	7200	7200	7200	7200	7200	7200	7200	7200	7200	7200	6978	6480	6048	5670
	S	-	262	131	87	65	52	43	37	32	29	26	23	21	20	18	17	16
$k_t \times b$ (-)		0,0	292,7	585,5	878,2	1170,9	1463,6	1756,4	2049,1	2341,8	2634,5	2927,3	3220,0	3512,7	3805,5	4098,2	4390,9	4683,6

TTM: Timber-Timber-Maximum | TTP: Timber-Timber-Partial | TCM: Timber-Concrete-Maximum | TCP: Timber-Concrete-Partial

T: $F_{T,Rk}$ load-carrying capacity of timber | S: $F_{S,Rk}$ load-carrying capacity of steel

Table B. 39 Angle bracket type 6503S, Variant TCP, Fastener GH Nail 4x60, Density 350 kg/m³

Characteristic load-carrying capacity $F_{1,Rk}$ (N) for one / two angle brackets																		
angle bracket	1													2				
f (mm)	0	10	20	30	40	50	60	70	80	90	100	110	120	0				
$F_{1,Rk}$	T	9456	6750	3375	2250	1688	1350	1125	964	844	750	675	614	563	18912			
	S	21	19	17	15	14	13	12	11	10	10	9	9	8	42			
k_1 (-)	14,6	16,5	18,3	20,1	21,9	23,7	25,5	27,4	29,2	31,0	32,8	34,6	36,5	7,3				
Characteristic load-carrying capacity $F_{2/3,Rk}$ (N) for one / two angle brackets																		
angle bracket	1	2																
$F_{2/3,Rk}$	T	1470	2940															
	S	-	-															
Characteristic load-carrying capacity $F_{4,Rk}$ (N) for one angle bracket																		
e (mm)	0	20	40	60	80	100	120	140	160	180	200	220	240	260	280	300	320	
$F_{4,Rk}$	T	-	-	-	19286	2872	1552	1063	808	652	547	470	413	368	332	302	277	256
	S	-	88	44	29	22	17	14	12	11	9	8	8	7	6	6	5	5
k_1 (-)	0,0	3,6	7,3	10,9	14,5	18,2	21,8	25,5	29,1	32,7	36,4	40,0	43,6	47,3	50,9	54,5	58,2	
Characteristic load-carrying capacity $F_{5,Rk}$ (N) for one angle bracket																		
b / e (mm)	0	20	40	60	80	100	120	140	160	180	200	220	240	260	280	300	320	
0	T	1195	1849	4091	1700	1275	1020	850	729	638	567	510	464	425	392	364	340	319
	S	281	435	600	400	300	240	200	171	150	133	120	109	100	92	85	80	75
20	T	1195	1849	4091	1700	1275	1020	850	729	638	567	510	464	425	392	364	340	319
	S	281	435	600	400	300	240	200	171	150	133	120	109	100	92	85	80	75
40	T	1195	1849	4091	1700	1275	1020	850	729	638	567	510	464	425	392	364	340	319
	S	281	435	600	400	300	240	200	171	150	133	120	109	100	92	85	80	75
60	T	1195	1849	4091	1700	1275	1020	850	729	638	567	510	464	425	392	364	340	319
	S	281	435	600	400	300	240	200	171	150	133	120	109	100	92	85	80	75
80	T	1195	1849	4091	1700	1275	1020	850	729	638	567	510	464	425	392	364	340	319
	S	281	435	600	400	300	240	200	171	150	133	120	109	100	92	85	80	75
100	T	1195	1849	4091	1700	1275	1020	850	729	638	567	510	464	425	392	364	340	319
	S	281	435	600	400	300	240	200	171	150	133	120	109	100	92	85	80	75
120	T	1195	1849	4091	1700	1275	1020	850	729	638	567	510	464	425	392	364	340	319
	S	281	435	600	400	300	240	200	171	150	133	120	109	100	92	85	80	75
140	T	1195	1849	4091	1700	1275	1020	850	729	638	567	510	464	425	392	364	340	319
	S	281	435	600	400	300	240	200	171	150	133	120	109	100	92	85	80	75
160	T	1195	1849	4091	1700	1275	1020	850	729	638	567	510	464	425	392	364	340	319
	S	281	435	600	400	300	240	200	171	150	133	120	109	100	92	85	80	75
180	T	1195	1849	4091	1700	1275	1020	850	729	638	567	510	464	425	392	364	340	319
	S	281	435	600	400	300	240	200	171	150	133	120	109	100	92	85	80	75
200	T	1195	1849	4091	1700	1275	1020	850	729	638	567	510	464	425	392	364	340	319
	S	281	435	600	400	300	240	200	171	150	133	120	109	100	92	85	80	75
220	T	1195	1849	4091	1700	1275	1020	850	729	638	567	510	464	425	392	364	340	319
	S	281	435	600	400	300	240	200	171	150	133	120	109	100	92	85	80	75
240	T	1195	1849	4091	1700	1275	1020	850	729	638	567	510	464	425	392	364	340	319
	S	281	435	600	400	300	240	200	171	150	133	120	109	100	92	85	80	75
$k_1 \times b$ (-)	0,0	15,2	30,5	45,7	61,0	76,2	91,4	106,7	121,9	137,1	152,4	167,6	182,9	198,1	213,3	228,6	243,8	
Characteristic load-carrying capacity $F_{4/5,Rk}$ (N) for two angle brackets																		
b / e (mm)	0	20	40	60	80	100	120	140	160	180	200	220	240	260	280	300	320	
0	T	12000	12000	12000	12000	12000	12000	12000	12000	12000	12000	12000	12000	12000	12000	12000	12000	
	S	-	-	-	-	-	-	-	-	-	-	-	-	-	-	-	-	
20	T	12000	9456	4728	3152	2364	1891	1576	1351	1182	1051	946	860	788	727	675	630	591
	S	-	21	10	7	5	4	3	3	2	2	2	1	1	1	1	1	1
40	T	12000	12000	9456	6304	4728	3782	3152	2702	2364	2101	1891	1719	1576	1455	1351	1261	1182
	S	-	43	21	14	10	8	7	6	5	4	4	3	3	3	3	2	2
60	T	12000	12000	12000	9456	7092	5674	4728	4053	3546	3152	2837	2579	2364	2182	2026	1891	1773
	S	-	65	32	21	16	13	10	9	8	7	6	5	5	4	4	4	4
80	T	12000	12000	12000	12000	9456	7565	6304	5403	4728	4203	3782	3439	3152	2910	2702	2522	2364
	S	-	87	43	29	21	17	14	12	10	9	8	7	7	6	6	5	5
100	T	12000	12000	12000	12000	11820	9456	7880	6754	5910	5253	4728	4298	3940	3637	3377	3152	2955
	S	-	109	54	36	27	21	18	15	13	12	10	9	9	8	7	7	6
120	T	12000	12000	12000	12000	11347	9456	8105	7092	6304	5674	5158	4728	4364	4053	3782	3546	
	S	-	131	65	43	32	26	21	18	16	14	13	11	10	9	8	8	
140	T	12000	12000	12000	12000	12000	11032	9456	8274	7355	6619	6017	5516	5092	4728	4413	4137	
	S	-	153	76	51	38	30	25	21	19	17	15	13	12	11	10	9	
160	T	12000	12000	12000	12000	12000	12000	10807	9456	8405	7565	6877	6304	5819	5403	5043	4728	
	S	-	174	87	58	43	34	29	24	21	19	17	15	14	13	12	11	10
180	T	12000	12000	12000	12000	12000	12000	12000	10638	9456	8510	7737	7092	6546	6079	5674	5319	
	S	-	196	98	65	49	39	32	28	24	21	19	17	16	15	14	13	12
200	T	12000	12000	12000	12000	12000	12000	12000	11820	10507	9456	8596	7880	7274	6754	6304	5910	
	S	-	218	109	72	54	43	36	31	27	24	21	19	18	16	15	14	13
220	T	12000	12000	12000	12000	12000	12000	12000	12000	11557	10402	9456	8668	8001	7430	6934	6501	
	S	-	240	120	80	60	48	40	34	30	26	24	21	20	18	17	16	15
240	T	12000	12000	12000	12000	12000	12000	12000	12000	12000	11347	10316	9456	8729	8105	7565	7092	
	S	-	262	131	87	65	52	43	37	32	29	26	23	21	20	18	17	16
$k_1 \times b$ (-)	0,0	292,7	585,5	878,2	1170,9	1463,6	1756,4	2049,1	2341,8	2634,5	2927,3	3220,0	3512,7	3805,5	4098,2	4390,9	4683,6	

TTM: Timber-Timber-Maximum | TTP: Timber-Timber-Partial | TCM: Timber-Concrete-Maximum | TCP: Timber-Concrete-Partial

T: $F_{T,Rk}$ load-carrying capacity of timber | S: $F_{S,Rk}$ load-carrying capacity of steel

Table B. 40 Angle bracket type 6503S, Variant TCP, Fastener GH Screw 5x40, Density 350 kg/m³

Characteristic load-carrying capacity $F_{1,Rk}$ (N) for one / two angle brackets															
angle bracket	1														2
f (mm)	0	10	20	30	40	50	60	70	80	90	100	110	120	0	
$F_{1,Rk}$	T	8012	8012	4253	2835	2126	1701	1418	1215	1063	945	851	773	709	16024
	S	21	19	17	15	14	13	12	11	10	10	9	9	8	42
k_t (-)	14,6	16,5	18,3	20,1	21,9	23,7	25,5	27,4	29,2	31,0	32,8	34,6	36,5	7,3	

Characteristic load-carrying capacity $F_{2/3,Rk}$ (N) for one / two angle brackets			
angle bracket	1	2	
$F_{2/3,Rk}$	T	1670	3340
	S	-	-

Characteristic load-carrying capacity $F_{4,Rk}$ (N) for one angle bracket																		
e (mm)	0	20	40	60	80	100	120	140	160	180	200	220	240	260	280	300	320	
$F_{4,Rk}$	T	-	-	-	24300	3619	1955	1339	1019	822	689	593	520	463	418	381	349	323
	S	-	88	44	29	22	17	14	12	11	9	8	8	7	6	6	5	5
k_t (-)	0,0	3,6	7,3	10,9	14,5	18,2	21,8	25,5	29,1	32,7	36,4	40,0	43,6	47,3	50,9	54,5	58,2	

Characteristic load-carrying capacity $F_{5,Rk}$ (N) for one angle bracket																		
b / e (mm)	0	20	40	60	80	100	120	140	160	180	200	220	240	260	280	300	320	
0	T	1505	2330	5155	2142	1607	1285	1071	918	803	714	643	584	536	494	459	428	402
	S	281	435	600	400	300	240	200	171	150	133	120	109	100	92	85	80	75
20	T	1505	2330	5155	2142	1607	1285	1071	918	803	714	643	584	536	494	459	428	402
	S	281	435	600	400	300	240	200	171	150	133	120	109	100	92	85	80	75
40	T	1505	2330	5155	2142	1607	1285	1071	918	803	714	643	584	536	494	459	428	402
	S	281	435	600	400	300	240	200	171	150	133	120	109	100	92	85	80	75
60	T	1505	2330	5155	2142	1607	1285	1071	918	803	714	643	584	536	494	459	428	402
	S	281	435	600	400	300	240	200	171	150	133	120	109	100	92	85	80	75
80	T	1505	2330	5155	2142	1607	1285	1071	918	803	714	643	584	536	494	459	428	402
	S	281	435	600	400	300	240	200	171	150	133	120	109	100	92	85	80	75
100	T	1505	2330	5155	2142	1607	1285	1071	918	803	714	643	584	536	494	459	428	402
	S	281	435	600	400	300	240	200	171	150	133	120	109	100	92	85	80	75
120	T	1505	2330	5155	2142	1607	1285	1071	918	803	714	643	584	536	494	459	428	402
	S	281	435	600	400	300	240	200	171	150	133	120	109	100	92	85	80	75
140	T	1505	2330	5155	2142	1607	1285	1071	918	803	714	643	584	536	494	459	428	402
	S	281	435	600	400	300	240	200	171	150	133	120	109	100	92	85	80	75
160	T	1505	2330	5155	2142	1607	1285	1071	918	803	714	643	584	536	494	459	428	402
	S	281	435	600	400	300	240	200	171	150	133	120	109	100	92	85	80	75
180	T	1505	2330	5155	2142	1607	1285	1071	918	803	714	643	584	536	494	459	428	402
	S	281	435	600	400	300	240	200	171	150	133	120	109	100	92	85	80	75
200	T	1505	2330	5155	2142	1607	1285	1071	918	803	714	643	584	536	494	459	428	402
	S	281	435	600	400	300	240	200	171	150	133	120	109	100	92	85	80	75
220	T	1505	2330	5155	2142	1607	1285	1071	918	803	714	643	584	536	494	459	428	402
	S	281	435	600	400	300	240	200	171	150	133	120	109	100	92	85	80	75
240	T	1505	2330	5155	2142	1607	1285	1071	918	803	714	643	584	536	494	459	428	402
	S	281	435	600	400	300	240	200	171	150	133	120	109	100	92	85	80	75
$k_t \times b$ (-)	0,0	15,2	30,5	45,7	61,0	76,2	91,4	106,7	121,9	137,1	152,4	167,6	182,9	198,1	213,3	228,6	243,8	

Characteristic load-carrying capacity $F_{4/5,Rk}$ (N) for two angle brackets																		
b / e (mm)	0	20	40	60	80	100	120	140	160	180	200	220	240	260	280	300	320	
0	T	15120	15120	15120	15120	15120	15120	15120	15120	15120	15120	15120	15120	15120	15120	15120	15120	
	S	-	-	-	-	-	-	-	-	-	-	-	-	-	-	-	-	
20	T	15120	8012	4006	2671	2003	1602	1335	1145	1002	890	801	728	668	616	572	534	501
	S	-	21	10	7	5	4	3	3	2	2	2	1	1	1	1	1	1
40	T	15120	15120	8012	5341	4006	3205	2671	2289	2003	1780	1602	1457	1335	1233	1145	1068	1002
	S	-	43	21	14	10	8	7	6	5	4	4	3	3	3	3	2	2
60	T	15120	15120	12018	8012	6009	4807	4006	3434	3005	2671	2404	2185	2003	1849	1717	1602	1502
	S	-	65	32	21	16	13	10	9	8	7	6	5	5	5	4	4	4
80	T	15120	15120	15120	10683	8012	6410	5341	4578	4006	3561	3205	2913	2671	2465	2289	2137	2003
	S	-	87	43	29	21	17	14	12	10	9	8	7	7	6	6	5	5
100	T	15120	15120	15120	13353	10015	8012	6677	5723	5008	4451	4006	3642	3338	3082	2861	2671	2504
	S	-	109	54	36	27	21	18	15	13	12	10	9	9	8	7	7	6
120	T	15120	15120	15120	15120	12018	9614	8012	6867	6009	5341	4807	4370	4006	3698	3434	3205	3005
	S	-	131	65	43	32	26	21	18	16	14	13	11	10	10	9	8	8
140	T	15120	15120	15120	15120	14021	11217	9347	8012	7011	6232	5608	5099	4674	4314	4006	3739	3505
	S	-	153	76	51	38	30	25	21	19	17	15	13	12	11	10	10	9
160	T	15120	15120	15120	15120	15120	12819	10683	9157	8012	7122	6410	5827	5341	4930	4578	4273	4006
	S	-	174	87	58	43	34	29	24	21	19	17	15	14	13	12	11	10
180	T	15120	15120	15120	15120	15120	14422	12018	10301	9014	8012	7211	6555	6009	5547	5151	4807	4507
	S	-	196	98	65	49	39	32	28	24	21	19	17	16	15	14	13	12
200	T	15120	15120	15120	15120	15120	15120	13353	11446	10015	8902	8012	7284	6677	6163	5723	5341	5008
	S	-	218	109	72	54	43	36	31	27	24	21	19	18	16	15	14	13
220	T	15120	15120	15120	15120	15120	15120	14689	12590	11017	9792	8813	8012	7344	6779	6295	5875	5508
	S	-	240	120	80	60	48	40	34	30	26	24	21	20	18	17	16	15
240	T	15120	15120	15120	15120	15120	15120	15120	13735	12018	10683	9614	8740	8012	7396	6867	6410	6009
	S	-	262	131	87	65	52	43	37	32	29	26	23	21	20	18	17	16
$k_t \times b$ (-)	0,0	292,7	585,5	878,2	1170,9	1463,6	1756,4	2049,1	2341,8	2634,5	2927,3	3220,0	3512,7	3805,5	4098,2	4390,9	4683,6	

TTM: Timber-Timber-Maximum | TTP: Timber-Timber-Partial | TCM: Timber-Concrete-Maximum | TCP: Timber-Concrete-Partial

T: $F_{1,T,Rk}$ load-carrying capacity of timber | S: $F_{1,S,Rk}$ load-carrying capacity of steel

Table B. 41 Angle bracket type 6503S, Variant TCP, Fastener GH Screw 5x60, Density 350 kg/m³Characteristic load-carrying capacity $F_{1,Rk}$ (N) for one / two angle brackets

angle bracket	1													2	
f (mm)	0	10	20	30	40	50	60	70	80	90	100	110	120	0	
$F_{1,Rk}$	T	9060	9060	6615	4410	3308	2646	2205	1890	1654	1470	1323	1203	1103	18120
	S	21	19	17	15	14	13	12	11	10	9	9	8	8	42
k_t (-)	14,6	16,5	18,3	20,1	21,9	23,7	25,5	27,4	29,2	31,0	32,8	34,6	36,5	7,3	

Characteristic load-carrying capacity $F_{2/3,Rk}$ (N) for one / two angle brackets

angle bracket	1	2	
$F_{2/3,Rk}$	T	2270	4540
	S	-	-

Characteristic load-carrying capacity $F_{4,Rk}$ (N) for one angle bracket

e (mm)	0	20	40	60	80	100	120	140	160	180	200	220	240	260	280	300	320	
$F_{4,Rk}$	T	-	-	-	37800	5630	3041	2083	1584	1278	1071	922	809	721	650	592	543	502
	S	-	88	44	29	22	17	14	12	11	9	8	8	7	6	6	5	5
k_t (-)	0,0	3,6	7,3	10,9	14,5	18,2	21,8	25,5	29,1	32,7	36,4	40,0	43,6	47,3	50,9	54,5	58,2	

Characteristic load-carrying capacity $F_{5,Rk}$ (N) for one angle bracket

b / e (mm)	0	20	40	60	80	100	120	140	160	180	200	220	240	260	280	300	320	
0	T	2342	3625	8018	3332	2499	1999	1666	1428	1250	1111	1000	909	833	769	714	666	625
	S	281	435	600	400	300	240	200	171	150	133	120	109	100	92	85	80	75
20	T	2342	3625	8018	3020	2265	1812	1510	1294	1133	1007	906	824	755	697	647	604	566
	S	281	435	600	400	300	240	200	171	150	133	120	109	100	92	85	80	75
40	T	2342	3625	8018	3332	2499	1999	1666	1428	1250	1111	1000	909	833	769	714	666	625
	S	281	435	600	400	300	240	200	171	150	133	120	109	100	92	85	80	75
60	T	2342	3625	8018	3332	2499	1999	1666	1428	1250	1111	1000	909	833	769	714	666	625
	S	281	435	600	400	300	240	200	171	150	133	120	109	100	92	85	80	75
80	T	2342	3625	8018	3332	2499	1999	1666	1428	1250	1111	1000	909	833	769	714	666	625
	S	281	435	600	400	300	240	200	171	150	133	120	109	100	92	85	80	75
100	T	2342	3625	8018	3332	2499	1999	1666	1428	1250	1111	1000	909	833	769	714	666	625
	S	281	435	600	400	300	240	200	171	150	133	120	109	100	92	85	80	75
120	T	2342	3625	8018	3332	2499	1999	1666	1428	1250	1111	1000	909	833	769	714	666	625
	S	281	435	600	400	300	240	200	171	150	133	120	109	100	92	85	80	75
140	T	2342	3625	8018	3332	2499	1999	1666	1428	1250	1111	1000	909	833	769	714	666	625
	S	281	435	600	400	300	240	200	171	150	133	120	109	100	92	85	80	75
160	T	2342	3625	8018	3332	2499	1999	1666	1428	1250	1111	1000	909	833	769	714	666	625
	S	281	435	600	400	300	240	200	171	150	133	120	109	100	92	85	80	75
180	T	2342	3625	8018	3332	2499	1999	1666	1428	1250	1111	1000	909	833	769	714	666	625
	S	281	435	600	400	300	240	200	171	150	133	120	109	100	92	85	80	75
200	T	2342	3625	8018	3332	2499	1999	1666	1428	1250	1111	1000	909	833	769	714	666	625
	S	281	435	600	400	300	240	200	171	150	133	120	109	100	92	85	80	75
220	T	2342	3625	8018	3332	2499	1999	1666	1428	1250	1111	1000	909	833	769	714	666	625
	S	281	435	600	400	300	240	200	171	150	133	120	109	100	92	85	80	75
240	T	2342	3625	8018	3332	2499	1999	1666	1428	1250	1111	1000	909	833	769	714	666	625
	S	281	435	600	400	300	240	200	171	150	133	120	109	100	92	85	80	75
$k_x \times b$ (-)	0,0	15,2	30,5	45,7	61,0	76,2	91,4	106,7	121,9	137,1	152,4	167,6	182,9	198,1	213,3	228,6	243,8	

Characteristic load-carrying capacity $F_{4/5,Rk}$ (N) for two angle brackets

b / e (mm)	0	20	40	60	80	100	120	140	160	180	200	220	240	260	280	300	320	
0	T	23519	23519	23519	23519	23519	23519	23519	23519	23519	23519	23519	23519	23519	23519	23519	23519	
	S	-	-	-	-	-	-	-	-	-	-	-	-	-	-	-	-	
20	T	23519	9060	4530	3020	2265	1812	1510	1294	1133	1007	906	824	755	697	647	604	566
	S	-	21	10	7	5	4	3	3	2	2	2	1	1	1	1	1	1
40	T	23519	18120	9060	6040	4530	3624	3020	2589	2265	2013	1812	1647	1510	1394	1294	1208	1133
	S	-	43	21	14	10	8	7	6	5	4	4	3	3	3	2	2	2
60	T	23519	23520	13590	9060	6795	5436	4530	3883	3398	3020	2718	2471	2265	2091	1941	1812	1699
	S	-	65	32	21	16	13	10	9	8	7	6	5	5	4	4	4	4
80	T	23519	23520	18120	12080	9060	7248	6040	5177	4530	4027	3624	3295	3020	2788	2589	2416	2265
	S	-	87	43	29	21	17	14	12	10	9	8	7	7	6	6	5	5
100	T	23519	23520	22650	15100	11325	9060	7550	6471	5663	5033	4530	4118	3775	3485	3236	3020	2831
	S	-	109	54	36	27	21	18	15	13	12	10	9	9	8	7	7	6
120	T	23519	23520	23520	18120	13590	10872	9060	7766	6795	6040	5436	4942	4530	4182	3883	3624	3398
	S	-	131	65	43	32	26	21	18	16	14	13	11	10	10	9	8	8
140	T	23519	23520	23520	21140	15855	12684	10570	9060	7928	7047	6342	5765	5285	4878	4530	4228	3964
	S	-	153	76	51	38	30	25	21	19	17	15	13	12	11	10	10	9
160	T	23519	23520	23520	23520	18120	14496	12080	10354	9060	8053	7248	6589	6040	5575	5177	4832	4530
	S	-	174	87	58	43	34	29	24	21	19	17	15	14	13	12	11	10
180	T	23519	23520	23520	23520	20385	16308	13590	11649	10193	9060	8154	7413	6795	6272	5824	5436	5096
	S	-	196	98	65	49	39	32	28	24	21	19	17	16	15	14	13	12
200	T	23519	23520	23520	23520	22650	18120	15100	12943	11325	10067	9060	8236	7550	6969	6471	6040	5663
	S	-	218	109	72	54	43	36	31	27	24	21	19	18	16	15	14	13
220	T	23519	23520	23520	23520	23520	19932	16610	14237	12458	11073	9966	9060	8305	7666	7119	6644	6229
	S	-	240	120	80	60	48	40	34	30	26	24	21	20	18	17	16	15
240	T	23519	23520	23520	23520	21744	18120	15531	13590	12080	10872	9884	9060	8363	7766	7248	6795	
	S	-	262	131	87	65	52	43	37	32	29	26	23	21	20	18	17	16
$k_x \times b$ (-)	0,0	292,7	585,5	878,2	1170,9	1463,6	1756,4	2049,1	2341,8	2634,5	2927,3	3220,0	3512,7	3805,5	4098,2	4390,9	4683,6	

TTM: Timber-Timber-Maximum | TTP: Timber-Timber-Partial | TCM: Timber-Concrete-Maximum | TCP: Timber-Concrete-Partial

T: $F_{T,Rk}$ load-carrying capacity of timber | S: $F_{S,Rk}$ load-carrying capacity of steel

Table B. 42 Angle bracket type 6503S, Variant TTM, Fastener GH Nail 4x40, Density 350 kg/m³Characteristic load-carrying capacity $F_{T,Rk}$ (N) for one / two angle brackets

angle bracket		1													2
f (mm)		0	10	20	30	40	50	60	70	80	90	100	110	120	0
$F_{T,Rk}$	T	1945	1652	1436	1270	1139	977	814	698	611	543	489	444	407	3889
	S	377	320	278	246	220	186	155	133	116	103	93	84	77	754

Characteristic load-carrying capacity $F_{2/3,Rk}$ (N) for one / two angle brackets

angle bracket		1	2
$F_{2/3,Rk}$	T	5460	10920
	S	-	-

Characteristic load-carrying capacity $F_{4,Rk}$ (N) for one angle bracket

e (mm)		0	20	40	60	80	100	120	140	160	180	200	220	240	260	280	300	320
$F_{4,Rk}$	T	18899	5494	2747	1831	1373	1099	769	585	472	396	340	299	266	240	219	201	185
	S	-	1065	532	355	266	213	147	111	90	75	65	57	50	45	41	38	35

Characteristic load-carrying capacity $F_{5,Rk}$ (N) for one angle bracket

b / e (mm)		0	20	40	60	80	100	120	140	160	180	200	220	240	260	280	300	320
0	T	865	1339	2961	2194	1645	1316	1097	940	823	731	658	598	548	506	470	439	411
	S	165	256	566	400	300	240	200	171	150	133	120	109	100	92	85	80	75
20	T	865	1339	2961	2194	1645	1316	1097	940	823	731	658	598	548	506	470	439	411
	S	165	256	566	400	300	240	200	171	150	133	120	109	100	92	85	80	75
40	T	865	1339	2961	2194	1645	1316	1097	940	823	731	658	598	548	506	470	439	411
	S	165	256	566	400	300	240	200	171	150	133	120	109	100	92	85	80	75
60	T	865	1339	2961	2194	1645	1316	1097	940	823	731	658	598	548	506	470	439	411
	S	165	256	566	400	300	240	200	171	150	133	120	109	100	92	85	80	75
80	T	865	1339	2961	2194	1645	1316	1097	940	823	731	658	598	548	506	470	439	411
	S	165	256	566	400	300	240	200	171	150	133	120	109	100	92	85	80	75
100	T	865	1339	2961	2194	1645	1316	1097	940	823	731	658	598	548	506	470	439	411
	S	165	256	566	400	300	240	200	171	150	133	120	109	100	92	85	80	75
120	T	865	1339	2961	2194	1645	1316	1097	940	823	731	658	598	548	506	470	439	411
	S	165	256	566	400	300	240	200	171	150	133	120	109	100	92	85	80	75
140	T	865	1339	2961	2194	1645	1316	1097	940	823	731	658	598	548	506	470	439	411
	S	165	256	566	400	300	240	200	171	150	133	120	109	100	92	85	80	75
160	T	865	1339	2961	2194	1645	1316	1097	940	823	731	658	598	548	506	470	439	411
	S	165	256	566	400	300	240	200	171	150	133	120	109	100	92	85	80	75
180	T	865	1339	2961	2194	1645	1316	1097	940	823	731	658	598	548	506	470	439	411
	S	165	256	566	400	300	240	200	171	150	133	120	109	100	92	85	80	75
200	T	865	1339	2961	2194	1645	1316	1097	940	823	731	658	598	548	506	470	439	411
	S	165	256	566	400	300	240	200	171	150	133	120	109	100	92	85	80	75
220	T	865	1339	2961	2194	1645	1316	1097	940	823	731	658	598	548	506	470	439	411
	S	165	256	566	400	300	240	200	171	150	133	120	109	100	92	85	80	75
240	T	865	1339	2961	2194	1645	1316	1097	940	823	731	658	598	548	506	470	439	411
	S	165	256	566	400	300	240	200	171	150	133	120	109	100	92	85	80	75

Characteristic load-carrying capacity $F_{4/5,Rk}$ (N) for two angle brackets

b / e (mm)		0	20	40	60	80	100	120	140	160	180	200	220	240	260	280	300	320
0	T	14400	14400	14400	14400	14400	14400	14400	14400	14400	14400	14400	14400	14400	14400	14400	14400	14400
	S	-	-	-	-	-	-	-	-	-	-	-	-	-	-	-	-	-
20	T	14400	1945	972	648	486	389	324	278	243	216	194	177	162	150	139	130	122
	S	-	377	188	125	94	75	62	53	47	41	37	34	31	29	26	25	23
40	T	14400	3889	1945	1296	972	778	648	556	486	432	389	354	324	299	278	259	243
	S	-	754	377	251	188	150	125	107	94	83	75	68	62	58	53	50	47
60	T	14400	5834	2917	1945	1458	1167	972	833	729	648	583	530	486	449	417	389	365
	S	-	1131	565	377	282	226	188	161	141	125	113	102	94	87	80	75	70
80	T	14400	7779	3889	2593	1945	1556	1296	1111	972	864	778	707	648	598	556	519	486
	S	-	1508	754	502	377	301	251	215	188	167	150	137	125	116	107	100	94
100	T	14400	9723	4862	3241	2431	1945	1621	1389	1215	1080	972	884	810	748	695	648	608
	S	-	1886	943	628	471	377	314	269	235	209	188	171	157	145	134	125	117
120	T	14400	11668	5834	3889	2917	2334	1945	1667	1458	1296	1167	1061	972	898	833	778	729
	S	-	2263	1131	754	565	452	377	323	282	251	226	205	188	174	161	150	141
140	T	14400	13613	6806	4538	3403	2723	2269	1945	1702	1513	1361	1238	1134	1047	972	908	851
	S	-	2640	1320	880	660	528	440	377	330	293	264	240	220	203	188	176	165
160	T	14400	14400	7779	5186	3889	3111	2593	2222	1945	1729	1556	1414	1296	1197	1111	1037	972
	S	-	3017	1508	1005	754	603	502	431	377	335	301	274	251	232	215	201	188
180	T	14400	14400	8751	5834	4375	3500	2917	2500	2188	1945	1750	1591	1458	1346	1250	1167	1094
	S	-	3395	1697	1131	848	679	565	485	424	377	339	308	282	261	242	226	212
200	T	14400	14400	9723	6482	4862	3889	3241	2778	2431	2161	1945	1768	1621	1496	1389	1296	1215
	S	-	3772	1886	1257	943	754	628	538	471	419	377	342	314	290	269	251	235
220	T	14400	14400	10696	7130	5348	4278	3565	3056	2674	2377	2139	1945	1783	1645	1528	1426	1337
	S	-	4149	2074	1383	1037	829	691	592	518	461	414	377	345	319	296	276	259
240	T	14400	14400	11668	7779	5834	4667	3889	3334	2917	2593	2334	2121	1945	1795	1667	1556	1458
	S	-	4526	2263	1508	1131	905	754	646	565	502	452	411	377	348	323	301	282

TTM: Timber-Timber-Maximum | TTP: Timber-Timber-Partial | TCM: Timber-Concrete-Maximum | TCP: Timber-Concrete-Partial

T: $F_{T,Rk}$ load-carrying capacity of timber | S: $F_{S,Rk}$ load-carrying capacity of steel

Table B. 43 Angle bracket type 6503S, Variant TTM, Fastener GH Nail 4x60, Density 350 kg/m³Characteristic load-carrying capacity $F_{T,Rk}$ (N) for one / two angle brackets

angle bracket		1													2
f (mm)		0	10	20	30	40	50	60	70	80	90	100	110	120	0
$F_{T,Rk}$	T	3241	2754	2394	2117	1898	1629	1357	1163	1018	905	814	740	679	6482
	S	377	320	278	246	220	186	155	133	116	103	93	84	77	754

Characteristic load-carrying capacity $F_{2/3,Rk}$ (N) for one / two angle brackets

angle bracket		1	2
$F_{2/3,Rk}$	T	7090	14180
	S	-	-

Characteristic load-carrying capacity $F_{4,Rk}$ (N) for one angle bracket

e (mm)		0	20	40	60	80	100	120	140	160	180	200	220	240	260	280	300	320
$F_{4,Rk}$	T	23639	9156	4578	3052	2289	1831	1282	975	787	659	567	498	444	400	364	334	309
	S	-	1065	532	355	266	213	147	111	90	75	65	57	50	45	41	38	35

Characteristic load-carrying capacity $F_{5,Rk}$ (N) for one angle bracket

b / e (mm)		0	20	40	60	80	100	120	140	160	180	200	220	240	260	280	300	320
0	T	1441	2231	4935	3656	2742	2194	1828	1567	1371	1219	1097	997	914	844	783	731	686
	S	165	256	566	400	300	240	200	171	150	133	120	109	100	92	85	80	75
20	T	1441	2231	4935	3656	2742	2194	1828	1567	1371	1219	1097	997	914	844	783	731	686
	S	165	256	566	400	300	240	200	171	150	133	120	109	100	92	85	80	75
40	T	1441	2231	4935	3656	2742	2194	1828	1567	1371	1219	1097	997	914	844	783	731	686
	S	165	256	566	400	300	240	200	171	150	133	120	109	100	92	85	80	75
60	T	1441	2231	4935	3656	2742	2194	1828	1567	1371	1219	1097	997	914	844	783	731	686
	S	165	256	566	400	300	240	200	171	150	133	120	109	100	92	85	80	75
80	T	1441	2231	4935	3656	2742	2194	1828	1567	1371	1219	1097	997	914	844	783	731	686
	S	165	256	566	400	300	240	200	171	150	133	120	109	100	92	85	80	75
100	T	1441	2231	4935	3656	2742	2194	1828	1567	1371	1219	1097	997	914	844	783	731	686
	S	165	256	566	400	300	240	200	171	150	133	120	109	100	92	85	80	75
120	T	1441	2231	4935	3656	2742	2194	1828	1567	1371	1219	1097	997	914	844	783	731	686
	S	165	256	566	400	300	240	200	171	150	133	120	109	100	92	85	80	75
140	T	1441	2231	4935	3656	2742	2194	1828	1567	1371	1219	1097	997	914	844	783	731	686
	S	165	256	566	400	300	240	200	171	150	133	120	109	100	92	85	80	75
160	T	1441	2231	4935	3656	2742	2194	1828	1567	1371	1219	1097	997	914	844	783	731	686
	S	165	256	566	400	300	240	200	171	150	133	120	109	100	92	85	80	75
180	T	1441	2231	4935	3656	2742	2194	1828	1567	1371	1219	1097	997	914	844	783	731	686
	S	165	256	566	400	300	240	200	171	150	133	120	109	100	92	85	80	75
200	T	1441	2231	4935	3656	2742	2194	1828	1567	1371	1219	1097	997	914	844	783	731	686
	S	165	256	566	400	300	240	200	171	150	133	120	109	100	92	85	80	75
220	T	1441	2231	4935	3656	2742	2194	1828	1567	1371	1219	1097	997	914	844	783	731	686
	S	165	256	566	400	300	240	200	171	150	133	120	109	100	92	85	80	75
240	T	1441	2231	4935	3656	2742	2194	1828	1567	1371	1219	1097	997	914	844	783	731	686
	S	165	256	566	400	300	240	200	171	150	133	120	109	100	92	85	80	75

Characteristic load-carrying capacity $F_{4/5,Rk}$ (N) for two angle brackets

b / e (mm)		0	20	40	60	80	100	120	140	160	180	200	220	240	260	280	300	320
0	T	23999	23999	23999	23999	23999	23999	23999	23999	23999	23999	23999	23999	23999	23999	23999	23999	23999
	S	-	-	-	-	-	-	-	-	-	-	-	-	-	-	-	-	-
20	T	23999	3241	1621	1080	810	648	540	463	405	360	324	295	270	249	232	216	203
	S	-	377	188	125	94	75	62	53	47	41	37	34	31	29	26	25	23
40	T	23999	6482	3241	2161	1621	1296	1080	926	810	720	648	589	540	499	463	432	405
	S	-	754	377	251	188	150	125	107	94	83	75	68	62	58	53	50	47
60	T	23999	9723	4862	3241	2431	1945	1621	1389	1215	1080	972	884	810	748	695	648	608
	S	-	1131	565	377	282	226	188	161	141	125	113	102	94	87	80	75	70
80	T	23999	12964	6482	4321	3241	2593	2161	1852	1621	1440	1296	1179	1080	997	926	864	810
	S	-	1508	754	502	377	301	251	215	188	167	150	137	125	116	107	100	94
100	T	23999	16205	8103	5402	4051	3241	2701	2315	2026	1801	1621	1473	1350	1247	1158	1080	1013
	S	-	1886	943	628	471	377	314	269	235	209	188	171	157	145	134	125	117
120	T	23999	19447	9723	6482	4862	3889	3241	2778	2431	2161	1945	1768	1621	1496	1389	1296	1215
	S	-	2263	1131	754	565	452	377	323	282	251	226	205	188	174	161	150	141
140	T	23999	22688	11344	7563	5672	4538	3781	3241	2836	2521	2269	2063	1891	1745	1621	1513	1418
	S	-	2640	1320	880	660	528	440	377	330	293	264	240	220	203	188	176	165
160	T	23999	24000	12964	8643	6482	5186	4321	3704	3241	2881	2593	2357	2161	1995	1852	1729	1621
	S	-	3017	1508	1005	754	603	502	431	377	335	301	274	251	232	215	201	188
180	T	23999	24000	14585	9723	7292	5834	4862	4167	3646	3241	2917	2652	2431	2244	2084	1945	1823
	S	-	3395	1697	1131	848	679	565	485	424	377	339	308	282	261	242	226	212
200	T	23999	24000	16205	10804	8103	6482	5402	4630	4051	3601	3241	2946	2701	2493	2315	2161	2026
	S	-	3772	1886	1257	943	754	628	538	471	419	377	342	314	290	269	251	235
220	T	23999	24000	17826	11884	8913	7130	5942	5093	4456	3961	3565	3241	2971	2742	2547	2377	2228
	S	-	4149	2074	1383	1037	829	691	592	518	461	414	377	345	319	296	276	259
240	T	23999	24000	19447	12964	9723	7779	6482	5556	4862	4321	3889	3536	3241	2992	2778	2593	2431
	S	-	4526	2263	1508	1131	905	754	646	565	502	452	411	377	348	323	301	282

TTM: Timber-Timber-Maximum | TTP: Timber-Timber-Partial | TCM: Timber-Concrete-Maximum | TCP: Timber-Concrete-Partial

T: $F_{T,Rk}$ load-carrying capacity of timber | S: $F_{S,Rk}$ load-carrying capacity of steel

Table B. 44 Angle bracket type 6503S, Variant TTM, Fastener GH Screw 5x40, Density 350 kg/m³Characteristic load-carrying capacity $F_{1,Rk}$ (N) for one / two angle brackets

angle bracket		1													2
f (mm)		0	10	20	30	40	50	60	70	80	90	100	110	120	0
$F_{1,Rk}$	T	4084	3470	3016	2667	2391	2052	1710	1466	1283	1140	1026	933	855	8168
	S	377	320	278	246	220	186	155	133	116	103	93	84	77	754

Characteristic load-carrying capacity $F_{2/3,Rk}$ (N) for one / two angle brackets

angle bracket		1	2
$F_{2/3,Rk}$	T	6270	12540
	S	-	-

Characteristic load-carrying capacity $F_{4,Rk}$ (N) for one angle bracket

e (mm)		0	20	40	60	80	100	120	140	160	180	200	240	260	280	300	320	
$F_{4,Rk}$	T	20029	11537	5768	3846	2884	2307	1616	1229	991	831	715	628	559	504	459	421	389
	S	-	1065	532	355	266	213	147	111	90	75	65	57	50	45	41	38	35

Characteristic load-carrying capacity $F_{5,Rk}$ (N) for one angle bracket

b / e (mm)		0	20	40	60	80	100	120	140	160	180	200	220	240	260	280	300	320
0	T	1816	2811	6218	4607	3455	2764	2303	1974	1727	1536	1382	1256	1152	1063	987	921	864
	S	165	256	566	400	300	240	200	171	150	133	120	109	100	92	85	80	75
20	T	1816	2811	6218	4607	3455	2764	2303	1974	1727	1536	1382	1256	1152	1063	987	921	864
	S	165	256	566	400	300	240	200	171	150	133	120	109	100	92	85	80	75
40	T	1816	2811	6218	4607	3455	2764	2303	1974	1727	1536	1382	1256	1152	1063	987	921	864
	S	165	256	566	400	300	240	200	171	150	133	120	109	100	92	85	80	75
60	T	1816	2811	6218	4607	3455	2764	2303	1974	1727	1536	1382	1256	1152	1063	987	921	864
	S	165	256	566	400	300	240	200	171	150	133	120	109	100	92	85	80	75
80	T	1816	2811	6218	4607	3455	2764	2303	1974	1727	1536	1382	1256	1152	1063	987	921	864
	S	165	256	566	400	300	240	200	171	150	133	120	109	100	92	85	80	75
100	T	1816	2811	6218	4607	3455	2764	2303	1974	1727	1536	1382	1256	1152	1063	987	921	864
	S	165	256	566	400	300	240	200	171	150	133	120	109	100	92	85	80	75
120	T	1816	2811	6218	4607	3455	2764	2303	1974	1727	1536	1382	1256	1152	1063	987	921	864
	S	165	256	566	400	300	240	200	171	150	133	120	109	100	92	85	80	75
140	T	1816	2811	6218	4607	3455	2764	2303	1974	1727	1536	1382	1256	1152	1063	987	921	864
	S	165	256	566	400	300	240	200	171	150	133	120	109	100	92	85	80	75
160	T	1816	2811	6218	4607	3455	2764	2303	1974	1727	1536	1382	1256	1152	1063	987	921	864
	S	165	256	566	400	300	240	200	171	150	133	120	109	100	92	85	80	75
180	T	1816	2811	6218	4607	3455	2764	2303	1974	1727	1536	1382	1256	1152	1063	987	921	864
	S	165	256	566	400	300	240	200	171	150	133	120	109	100	92	85	80	75
200	T	1816	2811	6218	4607	3455	2764	2303	1974	1727	1536	1382	1256	1152	1063	987	921	864
	S	165	256	566	400	300	240	200	171	150	133	120	109	100	92	85	80	75
220	T	1816	2811	6218	4607	3455	2764	2303	1974	1727	1536	1382	1256	1152	1063	987	921	864
	S	165	256	566	400	300	240	200	171	150	133	120	109	100	92	85	80	75
240	T	1816	2811	6218	4607	3455	2764	2303	1974	1727	1536	1382	1256	1152	1063	987	921	864
	S	165	256	566	400	300	240	200	171	150	133	120	109	100	92	85	80	75

Characteristic load-carrying capacity $F_{4/5,Rk}$ (N) for two angle brackets

b / e (mm)		0	20	40	60	80	100	120	140	160	180	200	220	240	260	280	300	320
0	T	30239	30239	30239	30239	30239	30239	30239	30239	30239	30239	30239	30239	30239	30239	30239	30239	30239
	S	-	-	-	-	-	-	-	-	-	-	-	-	-	-	-	-	-
20	T	30239	4084	2042	1361	1021	817	681	583	510	454	408	371	340	314	292	272	255
	S	-	377	188	125	94	75	62	53	47	41	37	34	31	29	26	25	23
40	T	30239	8168	4084	2723	2042	1634	1361	1167	1021	908	817	743	681	628	583	545	510
	S	-	754	377	251	188	150	125	107	94	83	75	68	62	58	53	50	47
60	T	30239	12251	6126	4084	3063	2450	2042	1750	1531	1361	1225	1114	1021	942	875	817	766
	S	-	1131	565	377	282	226	188	161	141	125	113	102	94	87	80	75	70
80	T	30239	16335	8168	5445	4084	3267	2723	2334	2042	1815	1634	1485	1361	1257	1167	1089	1021
	S	-	1508	754	502	377	301	251	215	188	167	150	137	125	116	107	100	94
100	T	30239	20419	10209	6806	5105	4084	3403	2917	2552	2269	2042	1856	1702	1571	1458	1361	1276
	S	-	1886	943	628	471	377	314	269	235	209	188	171	157	145	134	125	117
120	T	30239	24503	12251	8168	6126	4901	4084	3500	3063	2723	2450	2228	2042	1885	1750	1634	1531
	S	-	2263	1131	754	565	452	377	323	282	251	226	205	188	174	161	150	141
140	T	30239	28586	14293	9529	7147	5717	4764	4084	3573	3176	2859	2599	2382	2199	2042	1906	1787
	S	-	2640	1320	880	660	528	440	377	330	293	264	240	220	203	188	176	165
160	T	30239	30240	16335	10890	8168	6534	5445	4667	4084	3630	3267	2970	2723	2513	2334	2178	2042
	S	-	3017	1508	1005	754	603	502	431	377	335	301	274	251	232	215	201	188
180	T	30239	30240	18377	12251	9188	7351	6126	5251	4594	4084	3675	3341	3063	2827	2625	2450	2297
	S	-	3395	1697	1131	848	679	565	485	424	377	339	308	282	261	242	226	212
200	T	30239	30240	20419	13613	10209	8168	6806	5834	5105	4538	4084	3713	3403	3141	2917	2723	2552
	S	-	3772	1886	1257	943	754	628	538	471	419	377	342	314	290	269	251	235
220	T	30239	30240	22461	14974	11230	8984	7487	6417	5615	4991	4492	4084	3743	3456	3209	2995	2808
	S	-	4149	2074	1383	1037	829	691	592	518	461	414	377	345	319	296	276	259
240	T	30239	30240	24503	16335	12251	9801	8168	7001	6126	5445	4901	4455	4084	3770	3500	3267	3063
	S	-	4526	2263	1508	1131	905	754	646	565	502	452	411	377	348	323	301	282

TTM: Timber-Timber-Maximum | TTP: Timber-Timber-Partial | TCM: Timber-Concrete-Maximum | TCP: Timber-Concrete-Partial

T: $F_{1,T,Rk}$ load-carrying capacity of timber | S: $F_{1,S,Rk}$ load-carrying capacity of steel

Table B. 45 Angle bracket type 6503S, Variant TTM, Fastener GH Screw 5x60, Density 350 kg/m³Characteristic load-carrying capacity $F_{T,Rk}$ (N) for one / two angle brackets

angle bracket		1													2
f (mm)		0	10	20	30	40	50	60	70	80	90	100	110	120	0
$F_{T,Rk}$	T	6353	5397	4692	4149	3719	3192	2660	2280	1995	1773	1596	1451	1330	12705
	S	377	320	278	246	220	186	155	133	116	103	93	84	77	754

Characteristic load-carrying capacity $F_{2/3,Rk}$ (N) for one / two angle brackets

angle bracket		1	2
$F_{2/3,Rk}$	T	7280	14560
	S	-	-

Characteristic load-carrying capacity $F_{4,Rk}$ (N) for one angle bracket

e (mm)		0	20	40	60	80	100	120	140	160	180	200	220	240	260	280	300	320
$F_{4,Rk}$	T	22649	17946	8973	5982	4486	3589	2513	1911	1542	1292	1112	976	870	784	714	655	606
	S	-	1065	532	355	266	213	147	111	90	75	65	57	50	45	41	38	35

Characteristic load-carrying capacity $F_{5,Rk}$ (N) for one angle bracket

b / e (mm)		0	20	40	60	80	100	120	140	160	180	200	220	240	260	280	300	320
0	T	2825	4373	9673	7166	5374	4299	3583	3071	2687	2389	2150	1954	1791	1654	1536	1433	1344
	S	165	256	566	400	300	240	200	171	150	133	120	109	100	92	85	80	75
20	T	2825	4373	9673	6040	4530	3624	3020	2589	2265	2013	1812	1647	1510	1394	1294	1208	1133
	S	165	256	566	400	300	240	200	171	150	133	120	109	100	92	85	80	75
40	T	2825	4373	9673	7166	5374	4299	3583	3071	2687	2389	2150	1954	1791	1654	1536	1433	1344
	S	165	256	566	400	300	240	200	171	150	133	120	109	100	92	85	80	75
60	T	2825	4373	9673	7166	5374	4299	3583	3071	2687	2389	2150	1954	1791	1654	1536	1433	1344
	S	165	256	566	400	300	240	200	171	150	133	120	109	100	92	85	80	75
80	T	2825	4373	9673	7166	5374	4299	3583	3071	2687	2389	2150	1954	1791	1654	1536	1433	1344
	S	165	256	566	400	300	240	200	171	150	133	120	109	100	92	85	80	75
100	T	2825	4373	9673	7166	5374	4299	3583	3071	2687	2389	2150	1954	1791	1654	1536	1433	1344
	S	165	256	566	400	300	240	200	171	150	133	120	109	100	92	85	80	75
120	T	2825	4373	9673	7166	5374	4299	3583	3071	2687	2389	2150	1954	1791	1654	1536	1433	1344
	S	165	256	566	400	300	240	200	171	150	133	120	109	100	92	85	80	75
140	T	2825	4373	9673	7166	5374	4299	3583	3071	2687	2389	2150	1954	1791	1654	1536	1433	1344
	S	165	256	566	400	300	240	200	171	150	133	120	109	100	92	85	80	75
160	T	2825	4373	9673	7166	5374	4299	3583	3071	2687	2389	2150	1954	1791	1654	1536	1433	1344
	S	165	256	566	400	300	240	200	171	150	133	120	109	100	92	85	80	75
180	T	2825	4373	9673	7166	5374	4299	3583	3071	2687	2389	2150	1954	1791	1654	1536	1433	1344
	S	165	256	566	400	300	240	200	171	150	133	120	109	100	92	85	80	75
200	T	2825	4373	9673	7166	5374	4299	3583	3071	2687	2389	2150	1954	1791	1654	1536	1433	1344
	S	165	256	566	400	300	240	200	171	150	133	120	109	100	92	85	80	75
220	T	2825	4373	9673	7166	5374	4299	3583	3071	2687	2389	2150	1954	1791	1654	1536	1433	1344
	S	165	256	566	400	300	240	200	171	150	133	120	109	100	92	85	80	75
240	T	2825	4373	9673	7166	5374	4299	3583	3071	2687	2389	2150	1954	1791	1654	1536	1433	1344
	S	165	256	566	400	300	240	200	171	150	133	120	109	100	92	85	80	75

Characteristic load-carrying capacity $F_{4/5,Rk}$ (N) for two angle brackets

b / e (mm)		0	20	40	60	80	100	120	140	160	180	200	220	240	260	280	300	320
0	T	45300	45300	45300	45300	45300	45300	45300	45300	45300	45300	45300	45300	45300	45300	45300	45300	45300
	S	-	-	-	-	-	-	-	-	-	-	-	-	-	-	-	-	-
20	T	45300	6353	3176	2118	1588	1271	1059	908	794	706	635	578	529	489	454	424	397
	S	-	377	188	125	94	75	62	53	47	41	37	34	31	29	26	25	23
40	T	45300	12705	6353	4235	3176	2541	2118	1815	1588	1412	1271	1155	1059	977	908	847	794
	S	-	754	377	251	188	150	125	107	94	83	75	68	62	58	53	50	47
60	T	45300	19058	9529	6353	4764	3812	3176	2723	2382	2118	1906	1733	1588	1466	1361	1271	1191
	S	-	1131	565	377	282	226	188	161	141	125	113	102	94	87	80	75	70
80	T	45300	25410	12705	8470	6353	5082	4235	3630	3176	2823	2541	2310	2118	1955	1815	1694	1588
	S	-	1508	754	502	377	301	251	215	188	167	150	137	125	116	107	100	94
100	T	45300	31763	15881	10588	7941	6353	5294	4538	3970	3529	3176	2888	2647	2443	2269	2118	1985
	S	-	1886	943	628	471	377	314	269	235	209	188	171	157	145	134	125	117
120	T	45300	38115	19058	12705	9529	7623	6353	5445	4764	4235	3812	3465	3176	2932	2723	2541	2382
	S	-	2263	1131	754	565	452	377	323	282	251	226	205	188	174	161	150	141
140	T	45300	44468	22234	14823	11117	8894	7411	6353	5558	4941	4447	4043	3706	3421	3176	2965	2779
	S	-	2640	1320	880	660	528	440	377	330	293	264	240	220	203	188	176	165
160	T	45300	45300	25410	16940	12705	10164	8470	7260	6353	5647	5082	4620	4235	3909	3630	3388	3176
	S	-	3017	1508	1005	754	603	502	431	377	335	301	274	251	232	215	201	188
180	T	45300	45300	28586	19058	14293	11435	9529	8168	7147	6353	5717	5198	4764	4398	4084	3812	3573
	S	-	3395	1697	1131	848	679	565	485	424	377	339	308	282	261	242	226	212
200	T	45300	45300	31763	21175	15881	12705	10588	9075	7941	7058	6353	5775	5294	4887	4538	4235	3970
	S	-	3772	1886	1257	943	754	628	538	471	419	377	342	314	290	269	251	235
220	T	45300	45300	34939	23293	17469	13976	11646	9983	8735	7764	6988	6353	5823	5375	4991	4659	4367
	S	-	4149	2074	1383	1037	829	691	592	518	461	414	377	345	319	296	276	259
240	T	45300	45300	38115	25410	19058	15246	12705	10890	9529	8470	7623	6930	6353	5864	5445	5082	4764
	S	-	4526	2263	1508	1131	905	754	646	565	502	452	411	377	348	323	301	282

TTM: Timber-Timber-Maximum | TTP: Timber-Timber-Partial | TCM: Timber-Concrete-Maximum | TCP: Timber-Concrete-Partial

T: $F_{T,Rk}$ load-carrying capacity of timber | S: $F_{S,Rk}$ load-carrying capacity of steel

Table B. 46 Angle bracket type 6503S, Variant TTP, Fastener GH Nail 4x40, Density 350 kg/m³Characteristic load-carrying capacity $F_{T,Rk}$ (N) for one / two angle brackets

angle bracket		1													2
f (mm)		0	10	20	30	40	50	60	70	80	90	100	110	120	0
$F_{T,Rk}$	T	1833	1557	1354	1197	1013	810	675	579	506	450	405	368	338	3665
	S	585	497	432	382	342	310	264	226	198	176	158	144	132	1170

Characteristic load-carrying capacity $F_{2/3,Rk}$ (N) for one / two angle brackets

angle bracket		1	2
$F_{2/3,Rk}$	T	3530	7060
	S	-	-

Characteristic load-carrying capacity $F_{4,Rk}$ (N) for one angle bracket

e (mm)		0	20	40	60	80	100	120	140	160	180	200	220	240	260	280	300	320
$F_{4,Rk}$	T	11340	5177	2589	1726	1294	931	638	485	391	328	282	248	221	199	181	166	154
	S	-	1200	600	400	300	240	200	171	150	128	110	97	86	78	71	65	60

Characteristic load-carrying capacity $F_{5,Rk}$ (N) for one angle bracket

b / e (mm)		0	20	40	60	80	100	120	140	160	180	200	220	240	260	280	300	320
0	T	717	1110	1869	1020	765	612	510	437	383	340	306	278	255	235	219	204	191
	S	281	435	600	400	300	240	200	171	150	133	120	109	100	92	85	80	75
20	T	717	1110	2455	1020	765	612	510	437	383	340	306	278	255	235	219	204	191
	S	281	435	600	400	300	240	200	171	150	133	120	109	100	92	85	80	75
40	T	717	1110	2455	1020	765	612	510	437	383	340	306	278	255	235	219	204	191
	S	281	435	600	400	300	240	200	171	150	133	120	109	100	92	85	80	75
60	T	717	1110	2455	1020	765	612	510	437	383	340	306	278	255	235	219	204	191
	S	281	435	600	400	300	240	200	171	150	133	120	109	100	92	85	80	75
80	T	717	1110	2455	1020	765	612	510	437	383	340	306	278	255	235	219	204	191
	S	281	435	600	400	300	240	200	171	150	133	120	109	100	92	85	80	75
100	T	717	1110	2455	1020	765	612	510	437	383	340	306	278	255	235	219	204	191
	S	281	435	600	400	300	240	200	171	150	133	120	109	100	92	85	80	75
120	T	717	1110	2455	1020	765	612	510	437	383	340	306	278	255	235	219	204	191
	S	281	435	600	400	300	240	200	171	150	133	120	109	100	92	85	80	75
140	T	717	1110	2455	1020	765	612	510	437	383	340	306	278	255	235	219	204	191
	S	281	435	600	400	300	240	200	171	150	133	120	109	100	92	85	80	75
160	T	717	1110	2455	1020	765	612	510	437	383	340	306	278	255	235	219	204	191
	S	281	435	600	400	300	240	200	171	150	133	120	109	100	92	85	80	75
180	T	717	1110	2455	1020	765	612	510	437	383	340	306	278	255	235	219	204	191
	S	281	435	600	400	300	240	200	171	150	133	120	109	100	92	85	80	75
200	T	717	1110	2455	1020	765	612	510	437	383	340	306	278	255	235	219	204	191
	S	281	435	600	400	300	240	200	171	150	133	120	109	100	92	85	80	75
220	T	717	1110	2455	1020	765	612	510	437	383	340	306	278	255	235	219	204	191
	S	281	435	600	400	300	240	200	171	150	133	120	109	100	92	85	80	75
240	T	717	1110	2455	1020	765	612	510	437	383	340	306	278	255	235	219	204	191
	S	281	435	600	400	300	240	200	171	150	133	120	109	100	92	85	80	75

Characteristic load-carrying capacity $F_{4/5,Rk}$ (N) for two angle brackets

b / e (mm)		0	20	40	60	80	100	120	140	160	180	200	220	240	260	280	300	320
0	T	7199	7199	7199	7199	7199	7199	7199	7199	7199	7199	7199	7199	7199	7199	7199	7199	7199
	S	-	-	-	-	-	-	-	-	-	-	-	-	-	-	-	-	-
20	T	7199	1833	916	611	458	367	305	262	229	204	183	167	153	141	131	122	115
	S	-	585	292	195	146	117	97	83	73	65	58	53	48	45	41	39	36
40	T	7199	3665	1833	1222	916	733	611	524	458	407	367	333	305	282	262	244	229
	S	-	1171	585	390	292	234	195	167	146	130	117	106	97	90	83	78	73
60	T	7199	5498	2749	1833	1375	1100	916	785	687	611	550	500	458	423	393	367	344
	S	-	1757	878	585	439	351	292	251	219	195	175	159	146	135	125	117	109
80	T	7199	7200	3665	2444	1833	1466	1222	1047	916	815	733	666	611	564	524	489	458
	S	-	2343	1171	781	585	468	390	334	292	260	234	213	195	180	167	156	146
100	T	7199	7200	4582	3055	2291	1833	1527	1309	1145	1018	916	833	764	705	655	611	573
	S	-	2928	1464	976	732	585	488	418	366	325	292	266	244	225	209	195	183
120	T	7199	7200	5498	3665	2749	2199	1833	1571	1375	1222	1100	1000	916	846	785	733	687
	S	-	3514	1757	1171	878	702	585	502	439	390	351	319	292	270	251	234	219
140	T	7199	7200	6415	4276	3207	2566	2138	1833	1604	1425	1283	1166	1069	987	916	855	802
	S	-	4100	2050	1366	1025	820	683	585	512	455	410	372	341	315	292	273	256
160	T	7199	7200	7200	4887	3665	2932	2444	2095	1833	1629	1466	1333	1222	1128	1047	977	916
	S	-	4686	2343	1562	1171	937	781	669	585	520	468	426	390	360	334	312	292
180	T	7199	7200	7200	5498	4124	3299	2749	2356	2062	1833	1649	1499	1375	1269	1178	1100	1031
	S	-	5271	2635	1757	1317	1054	878	753	658	585	527	479	439	405	376	351	329
200	T	7199	7200	7200	6109	4582	3665	3055	2618	2291	2036	1833	1666	1527	1410	1309	1222	1145
	S	-	5857	2928	1952	1464	1171	976	836	732	650	585	532	488	450	418	390	366
220	T	7199	7200	7200	6720	5040	4032	3360	2880	2520	2240	2016	1833	1680	1551	1440	1344	1260
	S	-	6443	3221	2147	1610	1288	1073	920	805	715	644	585	536	495	460	429	402
240	T	7199	7200	7200	7200	5498	4399	3665	3142	2749	2444	2199	1999	1833	1692	1571	1466	1375
	S	-	7029	3514	2343	1757	1405	1171	1004	878	781	702	639	585	540	502	468	439

TTM: Timber-Timber-Maximum | TTP: Timber-Timber-Partial | TCM: Timber-Concrete-Maximum | TCP: Timber-Concrete-Partial

T: $F_{T,Rk}$ load-carrying capacity of timber | S: $F_{S,Rk}$ load-carrying capacity of steel

Table B. 47 Angle bracket type 6503S, Variant TTP, Fastener GH Nail 4x60, Density 350 kg/m³Characteristic load-carrying capacity $F_{T,Rk}$ (N) for one / two angle brackets

angle bracket		1													2
f (mm)		0	10	20	30	40	50	60	70	80	90	100	110	120	0
$F_{T,Rk}$	T	3055	2595	2256	1995	1688	1350	1125	964	844	750	675	614	563	6109
	S	585	497	432	382	342	310	264	226	198	176	158	144	132	1170

Characteristic load-carrying capacity $F_{2/3,Rk}$ (N) for one / two angle brackets

angle bracket		1	2
$F_{2/3,Rk}$	T	4650	9300
	S	-	-

Characteristic load-carrying capacity $F_{4,Rk}$ (N) for one angle bracket

e (mm)		0	20	40	60	80	100	120	140	160	180	200	220	240	260	280	300	320
$F_{4,Rk}$	T	14184	8629	4315	2876	2157	1552	1063	808	652	547	470	413	368	332	302	277	256
	S	-	1200	600	400	300	240	200	171	150	128	110	97	86	78	71	65	60

Characteristic load-carrying capacity $F_{5,Rk}$ (N) for one angle bracket

b / e (mm)		0	20	40	60	80	100	120	140	160	180	200	220	240	260	280	300	320
0	T	1195	1849	3115	1700	1275	1020	850	729	638	567	510	464	425	392	364	340	319
	S	281	435	600	400	300	240	200	171	150	133	120	109	100	92	85	80	75
20	T	1195	1849	4091	1700	1275	1020	850	729	638	567	510	464	425	392	364	340	319
	S	281	435	600	400	300	240	200	171	150	133	120	109	100	92	85	80	75
40	T	1195	1849	4091	1700	1275	1020	850	729	638	567	510	464	425	392	364	340	319
	S	281	435	600	400	300	240	200	171	150	133	120	109	100	92	85	80	75
60	T	1195	1849	4091	1700	1275	1020	850	729	638	567	510	464	425	392	364	340	319
	S	281	435	600	400	300	240	200	171	150	133	120	109	100	92	85	80	75
80	T	1195	1849	4091	1700	1275	1020	850	729	638	567	510	464	425	392	364	340	319
	S	281	435	600	400	300	240	200	171	150	133	120	109	100	92	85	80	75
100	T	1195	1849	4091	1700	1275	1020	850	729	638	567	510	464	425	392	364	340	319
	S	281	435	600	400	300	240	200	171	150	133	120	109	100	92	85	80	75
120	T	1195	1849	4091	1700	1275	1020	850	729	638	567	510	464	425	392	364	340	319
	S	281	435	600	400	300	240	200	171	150	133	120	109	100	92	85	80	75
140	T	1195	1849	4091	1700	1275	1020	850	729	638	567	510	464	425	392	364	340	319
	S	281	435	600	400	300	240	200	171	150	133	120	109	100	92	85	80	75
160	T	1195	1849	4091	1700	1275	1020	850	729	638	567	510	464	425	392	364	340	319
	S	281	435	600	400	300	240	200	171	150	133	120	109	100	92	85	80	75
180	T	1195	1849	4091	1700	1275	1020	850	729	638	567	510	464	425	392	364	340	319
	S	281	435	600	400	300	240	200	171	150	133	120	109	100	92	85	80	75
200	T	1195	1849	4091	1700	1275	1020	850	729	638	567	510	464	425	392	364	340	319
	S	281	435	600	400	300	240	200	171	150	133	120	109	100	92	85	80	75
220	T	1195	1849	4091	1700	1275	1020	850	729	638	567	510	464	425	392	364	340	319
	S	281	435	600	400	300	240	200	171	150	133	120	109	100	92	85	80	75
240	T	1195	1849	4091	1700	1275	1020	850	729	638	567	510	464	425	392	364	340	319
	S	281	435	600	400	300	240	200	171	150	133	120	109	100	92	85	80	75

Characteristic load-carrying capacity $F_{4/5,Rk}$ (N) for two angle brackets

b / e (mm)		0	20	40	60	80	100	120	140	160	180	200	220	240	260	280	300	320
0	T	12000	12000	12000	12000	12000	12000	12000	12000	12000	12000	12000	12000	12000	12000	12000	12000	12000
	S	-	-	-	-	-	-	-	-	-	-	-	-	-	-	-	-	-
20	T	12000	3055	1527	1018	764	611	509	436	382	339	305	278	255	235	218	204	191
	S	-	585	292	195	146	117	97	83	73	65	58	53	48	45	41	39	36
40	T	12000	6109	3055	2036	1527	1222	1018	873	764	679	611	555	509	470	436	407	382
	S	-	1171	585	390	292	234	195	167	146	130	117	106	97	90	83	78	73
60	T	12000	9164	4582	3055	2291	1833	1527	1309	1145	1018	916	833	764	705	655	611	573
	S	-	1757	878	585	439	351	292	251	219	195	175	159	146	135	125	117	109
80	T	12000	12000	6109	4073	3055	2444	2036	1745	1527	1358	1222	1111	1018	940	873	815	764
	S	-	2343	1171	781	585	468	390	334	292	260	234	213	195	180	167	156	146
100	T	12000	12000	7636	5091	3818	3055	2545	2182	1909	1697	1527	1388	1273	1175	1091	1018	955
	S	-	2928	1464	976	732	585	488	418	366	325	292	266	244	225	209	195	183
120	T	12000	12000	9164	6109	4582	3665	3055	2618	2291	2036	1833	1666	1527	1410	1309	1222	1145
	S	-	3514	1757	1171	878	702	585	502	439	390	351	319	292	270	251	234	219
140	T	12000	12000	10691	7127	5345	4276	3564	3055	2673	2376	2138	1944	1782	1645	1527	1425	1336
	S	-	4100	2050	1366	1025	820	683	585	512	455	410	372	341	315	292	273	256
160	T	12000	12000	12000	8145	6109	4887	4073	3491	3055	2715	2444	2221	2036	1880	1745	1629	1527
	S	-	4686	2343	1562	1171	937	781	669	585	520	468	426	390	360	334	312	292
180	T	12000	12000	12000	9164	6873	5498	4582	3927	3436	3055	2749	2499	2291	2115	1964	1833	1718
	S	-	5271	2635	1757	1317	1054	878	753	658	585	527	479	439	405	376	351	329
200	T	12000	12000	12000	10182	7636	6109	5091	4364	3818	3394	3055	2777	2545	2350	2182	2036	1909
	S	-	5857	2928	1952	1464	1171	976	836	732	650	585	532	488	450	418	390	366
220	T	12000	12000	12000	11200	8400	6720	5600	4800	4200	3733	3360	3055	2800	2585	2400	2240	2100
	S	-	6443	3221	2147	1610	1288	1073	920	805	715	644	585	536	495	460	429	402
240	T	12000	12000	12000	12000	9164	7331	6109	5236	4582	4073	3665	3332	3055	2820	2618	2444	2291
	S	-	7029	3514	2343	1757	1405	1171	1004	878	781	702	639	585	540	502	468	439

TTM: Timber-Timber-Maximum | TTP: Timber-Timber-Partial | TCM: Timber-Concrete-Maximum | TCP: Timber-Concrete-Partial

T: $F_{T,Rk}$ load-carrying capacity of timber | S: $F_{S,Rk}$ load-carrying capacity of steel

Table B. 48 Angle bracket type 6503S, Variant TTP, Fastener GH Screw 5x40, Density 350 kg/m³Characteristic load-carrying capacity $F_{T,Rk}$ (N) for one / two angle brackets

angle bracket		1													2
f (mm)		0	10	20	30	40	50	60	70	80	90	100	110	120	0
$F_{T,Rk}$	T	3849	3270	2843	2514	2126	1701	1418	1215	1063	945	851	773	709	7697
	S	585	497	432	382	342	310	264	226	198	176	158	144	132	1170

Characteristic load-carrying capacity $F_{2/3,Rk}$ (N) for one / two angle brackets

angle bracket		1	2
$F_{2/3,Rk}$	T	4220	8440
	S	-	-

Characteristic load-carrying capacity $F_{4,Rk}$ (N) for one angle bracket

e (mm)		0	20	40	60	80	100	120	140	160	180	200	220	240	260	280	300	320
$F_{4,Rk}$	T	12018	10873	5436	3624	2718	1955	1339	1019	822	689	593	520	463	418	381	349	323
	S	-	1200	600	400	300	240	200	171	150	128	110	97	86	78	71	65	60

Characteristic load-carrying capacity $F_{5,Rk}$ (N) for one angle bracket

b / e (mm)		0	20	40	60	80	100	120	140	160	180	200	220	240	260	280	300	320
0	T	1505	2330	3925	2142	1607	1285	1071	918	803	714	643	584	536	494	459	428	402
	S	281	435	600	400	300	240	200	171	150	133	120	109	100	92	85	80	75
20	T	1505	2330	5155	2142	1607	1285	1071	918	803	714	643	584	536	494	459	428	402
	S	281	435	600	400	300	240	200	171	150	133	120	109	100	92	85	80	75
40	T	1505	2330	5155	2142	1607	1285	1071	918	803	714	643	584	536	494	459	428	402
	S	281	435	600	400	300	240	200	171	150	133	120	109	100	92	85	80	75
60	T	1505	2330	5155	2142	1607	1285	1071	918	803	714	643	584	536	494	459	428	402
	S	281	435	600	400	300	240	200	171	150	133	120	109	100	92	85	80	75
80	T	1505	2330	5155	2142	1607	1285	1071	918	803	714	643	584	536	494	459	428	402
	S	281	435	600	400	300	240	200	171	150	133	120	109	100	92	85	80	75
100	T	1505	2330	5155	2142	1607	1285	1071	918	803	714	643	584	536	494	459	428	402
	S	281	435	600	400	300	240	200	171	150	133	120	109	100	92	85	80	75
120	T	1505	2330	5155	2142	1607	1285	1071	918	803	714	643	584	536	494	459	428	402
	S	281	435	600	400	300	240	200	171	150	133	120	109	100	92	85	80	75
140	T	1505	2330	5155	2142	1607	1285	1071	918	803	714	643	584	536	494	459	428	402
	S	281	435	600	400	300	240	200	171	150	133	120	109	100	92	85	80	75
160	T	1505	2330	5155	2142	1607	1285	1071	918	803	714	643	584	536	494	459	428	402
	S	281	435	600	400	300	240	200	171	150	133	120	109	100	92	85	80	75
180	T	1505	2330	5155	2142	1607	1285	1071	918	803	714	643	584	536	494	459	428	402
	S	281	435	600	400	300	240	200	171	150	133	120	109	100	92	85	80	75
200	T	1505	2330	5155	2142	1607	1285	1071	918	803	714	643	584	536	494	459	428	402
	S	281	435	600	400	300	240	200	171	150	133	120	109	100	92	85	80	75
220	T	1505	2330	5155	2142	1607	1285	1071	918	803	714	643	584	536	494	459	428	402
	S	281	435	600	400	300	240	200	171	150	133	120	109	100	92	85	80	75
240	T	1505	2330	5155	2142	1607	1285	1071	918	803	714	643	584	536	494	459	428	402
	S	281	435	600	400	300	240	200	171	150	133	120	109	100	92	85	80	75

Characteristic load-carrying capacity $F_{4/5,Rk}$ (N) for two angle brackets

b / e (mm)		0	20	40	60	80	100	120	140	160	180	200	220	240	260	280	300	320
0	T	15120	15120	15120	15120	15120	15120	15120	15120	15120	15120	15120	15120	15120	15120	15120	15120	15120
	S	-	-	-	-	-	-	-	-	-	-	-	-	-	-	-	-	-
20	T	15120	3849	1924	1283	962	770	641	550	481	428	385	350	321	296	275	257	241
	S	-	585	292	195	146	117	97	83	73	65	58	53	48	45	41	39	36
40	T	15120	7697	3849	2566	1924	1539	1283	1100	962	855	770	700	641	592	550	513	481
	S	-	1171	585	390	292	234	195	167	146	130	117	106	97	90	83	78	73
60	T	15120	11546	5773	3849	2887	2309	1924	1649	1443	1283	1155	1050	962	888	825	770	722
	S	-	1757	878	585	439	351	292	251	219	195	175	159	146	135	125	117	109
80	T	15120	15120	7697	5132	3849	3079	2566	2199	1924	1711	1539	1400	1283	1184	1100	1026	962
	S	-	2343	1171	781	585	468	390	334	292	260	234	213	195	180	167	156	146
100	T	15120	15120	9622	6415	4811	3849	3207	2749	2405	2138	1924	1749	1604	1480	1375	1283	1203
	S	-	2928	1464	976	732	585	488	418	366	325	292	266	244	225	209	195	183
120	T	15120	15120	11546	7697	5773	4618	3849	3299	2887	2566	2309	2099	1924	1776	1649	1539	1443
	S	-	3514	1757	1171	878	702	585	502	439	390	351	319	292	270	251	234	219
140	T	15120	15120	13470	8980	6735	5388	4490	3849	3368	2993	2694	2449	2245	2072	1924	1796	1684
	S	-	4100	2050	1366	1025	820	683	585	512	455	410	372	341	315	292	273	256
160	T	15120	15120	15120	10263	7697	6158	5132	4399	3849	3421	3079	2799	2566	2368	2199	2053	1924
	S	-	4686	2343	1562	1171	937	781	669	585	520	468	426	390	360	334	312	292
180	T	15120	15120	15120	11546	8660	6928	5773	4948	4330	3849	3464	3149	2887	2664	2474	2309	2165
	S	-	5271	2635	1757	1317	1054	878	753	658	585	527	479	439	405	376	351	329
200	T	15120	15120	15120	12829	9622	7697	6415	5498	4811	4276	3849	3499	3207	2961	2749	2566	2405
	S	-	5857	2928	1952	1464	1171	976	836	732	650	585	532	488	450	418	390	366
220	T	15120	15120	15120	14112	10584	8467	7056	6048	5292	4704	4234	3849	3528	3257	3024	2822	2646
	S	-	6443	3221	2147	1610	1288	1073	920	805	715	644	585	536	495	460	429	402
240	T	15120	15120	15120	15120	11546	9237	7697	6598	5773	5132	4618	4199	3849	3553	3299	3079	2887
	S	-	7029	3514	2343	1757	1405	1171	1004	878	781	702	639	585	540	502	468	439

TTM: Timber-Timber-Maximum | TTP: Timber-Timber-Partial | TCM: Timber-Concrete-Maximum | TCP: Timber-Concrete-Partial

T: $F_{T,Rk}$ load-carrying capacity of timber | S: $F_{S,Rk}$ load-carrying capacity of steel

Table B. 49 Angle bracket type 6503S, Variant TTP, Fastener GH Screw 5x60, Density 350 kg/m³Characteristic load-carrying capacity $F_{1,Rk}$ (N) for one / two angle brackets

angle bracket		1													2
f (mm)		0	10	20	30	40	50	60	70	80	90	100	110	120	0
$F_{1,Rk}$	T	5987	5087	4422	3911	3308	2646	2205	1890	1654	1470	1323	1203	1103	11974
	S	585	497	432	382	342	310	264	226	198	176	158	144	132	1170

Characteristic load-carrying capacity $F_{2/3,Rk}$ (N) for one / two angle brackets

angle bracket		1	2
$F_{2/3,Rk}$	T	4990	9980
	S	-	-

Characteristic load-carrying capacity $F_{4,Rk}$ (N) for one angle bracket

e (mm)		0	20	40	60	80	100	120	140	160	180	200	220	240	260	280	300	320
$F_{4,Rk}$	T	13590	13590	8456	5638	4228	3041	2083	1584	1278	1071	922	809	721	650	592	543	502
	S	-	1200	600	400	300	240	200	171	150	128	110	97	86	78	71	65	60

Characteristic load-carrying capacity $F_{5,Rk}$ (N) for one angle bracket

b / e (mm)		0	20	40	60	80	100	120	140	160	180	200	220	240	260	280	300	320
0	T	2342	3625	6105	3332	2499	1999	1666	1428	1250	1111	1000	909	833	769	714	666	625
	S	281	435	600	400	300	240	200	171	150	133	120	109	100	92	85	80	75
20	T	2342	3625	8018	3020	2265	1812	1510	1294	1133	1007	906	824	755	697	647	604	566
	S	281	435	600	400	300	240	200	171	150	133	120	109	100	92	85	80	75
40	T	2342	3625	8018	3332	2499	1999	1666	1428	1250	1111	1000	909	833	769	714	666	625
	S	281	435	600	400	300	240	200	171	150	133	120	109	100	92	85	80	75
60	T	2342	3625	8018	3332	2499	1999	1666	1428	1250	1111	1000	909	833	769	714	666	625
	S	281	435	600	400	300	240	200	171	150	133	120	109	100	92	85	80	75
80	T	2342	3625	8018	3332	2499	1999	1666	1428	1250	1111	1000	909	833	769	714	666	625
	S	281	435	600	400	300	240	200	171	150	133	120	109	100	92	85	80	75
100	T	2342	3625	8018	3332	2499	1999	1666	1428	1250	1111	1000	909	833	769	714	666	625
	S	281	435	600	400	300	240	200	171	150	133	120	109	100	92	85	80	75
120	T	2342	3625	8018	3332	2499	1999	1666	1428	1250	1111	1000	909	833	769	714	666	625
	S	281	435	600	400	300	240	200	171	150	133	120	109	100	92	85	80	75
140	T	2342	3625	8018	3332	2499	1999	1666	1428	1250	1111	1000	909	833	769	714	666	625
	S	281	435	600	400	300	240	200	171	150	133	120	109	100	92	85	80	75
160	T	2342	3625	8018	3332	2499	1999	1666	1428	1250	1111	1000	909	833	769	714	666	625
	S	281	435	600	400	300	240	200	171	150	133	120	109	100	92	85	80	75
180	T	2342	3625	8018	3332	2499	1999	1666	1428	1250	1111	1000	909	833	769	714	666	625
	S	281	435	600	400	300	240	200	171	150	133	120	109	100	92	85	80	75
200	T	2342	3625	8018	3332	2499	1999	1666	1428	1250	1111	1000	909	833	769	714	666	625
	S	281	435	600	400	300	240	200	171	150	133	120	109	100	92	85	80	75
220	T	2342	3625	8018	3332	2499	1999	1666	1428	1250	1111	1000	909	833	769	714	666	625
	S	281	435	600	400	300	240	200	171	150	133	120	109	100	92	85	80	75
240	T	2342	3625	8018	3332	2499	1999	1666	1428	1250	1111	1000	909	833	769	714	666	625
	S	281	435	600	400	300	240	200	171	150	133	120	109	100	92	85	80	75

Characteristic load-carrying capacity $F_{4/5,Rk}$ (N) for two angle brackets

b / e (mm)		0	20	40	60	80	100	120	140	160	180	200	220	240	260	280	300	320
0	T	23519	23519	23519	23519	23519	23519	23519	23519	23519	23519	23519	23519	23519	23519	23519	23519	23519
	S	-	-	-	-	-	-	-	-	-	-	-	-	-	-	-	-	-
20	T	23519	5987	2993	1996	1497	1197	998	855	748	665	599	544	499	461	428	399	374
	S	-	585	292	195	146	117	97	83	73	65	58	53	48	45	41	39	36
40	T	23519	11974	5987	3991	2993	2395	1996	1711	1497	1330	1197	1089	998	921	855	798	748
	S	-	1171	585	390	292	234	195	167	146	130	117	106	97	90	83	78	73
60	T	23519	17961	8980	5987	4490	3592	2993	2566	2245	1996	1796	1633	1497	1382	1283	1197	1123
	S	-	1757	878	585	439	351	292	251	219	195	175	159	146	135	125	117	109
80	T	23519	23520	11974	7983	5987	4790	3991	3421	2993	2661	2395	2177	1996	1842	1711	1597	1497
	S	-	2343	1171	781	585	468	390	334	292	260	234	213	195	180	167	156	146
100	T	23519	23520	14967	9978	7484	5987	4989	4276	3742	3326	2993	2721	2495	2303	2138	1996	1871
	S	-	2928	1464	976	732	585	488	418	366	325	292	266	244	225	209	195	183
120	T	23519	23520	17961	11974	8980	7184	5987	5132	4490	3991	3592	3266	2993	2763	2566	2395	2245
	S	-	3514	1757	1171	878	702	585	502	439	390	351	319	292	270	251	234	219
140	T	23519	23520	20954	13969	10477	8382	6985	5987	5239	4656	4191	3810	3492	3224	2993	2794	2619
	S	-	4100	2050	1366	1025	820	683	585	512	455	410	372	341	315	292	273	256
160	T	23519	23520	23520	15965	11974	9579	7983	6842	5987	5322	4790	4354	3991	3684	3421	3193	2993
	S	-	4686	2343	1562	1171	937	781	669	585	520	468	426	390	360	334	312	292
180	T	23519	23520	23520	17961	13470	10776	8980	7697	6735	5987	5388	4898	4490	4145	3849	3592	3368
	S	-	5271	2635	1757	1317	1054	878	753	658	585	527	479	439	405	376	351	329
200	T	23519	23520	23520	19956	14967	11974	9978	8553	7484	6652	5987	5443	4989	4605	4276	3991	3742
	S	-	5857	2928	1952	1464	1171	976	836	732	650	585	532	488	450	418	390	366
220	T	23519	23520	23520	21952	16464	13171	10976	9408	8232	7317	6586	5987	5488	5066	4704	4390	4116
	S	-	6443	3221	2147	1610	1288	1073	920	805	715	644	585	536	495	460	429	402
240	T	23519	23520	23520	23520	17961	14369	11974	10263	8980	7983	7184	6531	5987	5526	5132	4790	4490
	S	-	7029	3514	2343	1757	1405	1171	1004	878	781	702	639	585	540	502	468	439

TTM: Timber-Timber-Maximum | TTP: Timber-Timber-Partial | TCM: Timber-Concrete-Maximum | TCP: Timber-Concrete-Partial

T: $F_{1,T,Rk}$ load-carrying capacity of timber | S: $F_{1,S,Rk}$ load-carrying capacity of steel

Table B. 50 Angle bracket type 6503S13, Variant TCM, Fastener GH Nail 4x40, Density 350 kg/m³Characteristic load-carrying capacity $F_{1,Rk}$ (N) for one / two angle brackets

angle bracket		1													2
f (mm)		0	10	20	30	40	50	60	70	80	90	100	110	120	0
$F_{1,Rk}$	T	15120	4886	2443	1629	1221	977	814	698	611	543	489	444	407	30240
	S	25	22	20	18	17	15	14	13	12	12	11	10	10	50
$k_t (-)$		12,5	14,1	15,6	17,2	18,7	20,2	21,8	23,3	24,8	26,4	27,9	29,5	31,0	6,3

Characteristic load-carrying capacity $F_{2/3,Rk}$ (N) for one / two angle brackets

angle bracket		1	2
$F_{2/3,Rk}$	T	1760	3520
	S	-	-

Characteristic load-carrying capacity $F_{4,Rk}$ (N) for one angle bracket

e (mm)		0	20	40	60	80	100	120	140	160	180	200	220	240	260	280	300	320
$F_{4,Rk}$	T	-	-	-	13959	2079	1123	769	585	472	396	340	299	266	240	219	201	185
	S	-	104	52	34	26	20	17	14	13	11	10	9	8	8	7	6	6
$k_t (-)$		0,0	3,1	6,2	9,2	12,3	15,4	18,5	21,5	24,6	27,7	30,8	33,8	36,9	40,0	43,1	46,2	49,2

Characteristic load-carrying capacity $F_{5,Rk}$ (N) for one angle bracket

b / e (mm)		0	20	40	60	80	100	120	140	160	180	200	220	240	260	280	300	320
0	T	865	1339	2961	2194	1645	1316	1097	940	823	731	658	598	548	506	470	439	411
	S	165	256	566	400	300	240	200	171	150	133	120	109	100	92	85	80	75
20	T	865	1339	2961	2194	1645	1316	1097	940	823	731	658	598	548	506	470	439	411
	S	165	256	566	400	300	240	200	171	150	133	120	109	100	92	85	80	75
40	T	865	1339	2961	2194	1645	1316	1097	940	823	731	658	598	548	506	470	439	411
	S	165	256	566	400	300	240	200	171	150	133	120	109	100	92	85	80	75
60	T	865	1339	2961	2194	1645	1316	1097	940	823	731	658	598	548	506	470	439	411
	S	165	256	566	400	300	240	200	171	150	133	120	109	100	92	85	80	75
80	T	865	1339	2961	2194	1645	1316	1097	940	823	731	658	598	548	506	470	439	411
	S	165	256	566	400	300	240	200	171	150	133	120	109	100	92	85	80	75
100	T	865	1339	2961	2194	1645	1316	1097	940	823	731	658	598	548	506	470	439	411
	S	165	256	566	400	300	240	200	171	150	133	120	109	100	92	85	80	75
120	T	865	1339	2961	2194	1645	1316	1097	940	823	731	658	598	548	506	470	439	411
	S	165	256	566	400	300	240	200	171	150	133	120	109	100	92	85	80	75
140	T	865	1339	2961	2194	1645	1316	1097	940	823	731	658	598	548	506	470	439	411
	S	165	256	566	400	300	240	200	171	150	133	120	109	100	92	85	80	75
160	T	865	1339	2961	2194	1645	1316	1097	940	823	731	658	598	548	506	470	439	411
	S	165	256	566	400	300	240	200	171	150	133	120	109	100	92	85	80	75
180	T	865	1339	2961	2194	1645	1316	1097	940	823	731	658	598	548	506	470	439	411
	S	165	256	566	400	300	240	200	171	150	133	120	109	100	92	85	80	75
200	T	865	1339	2961	2194	1645	1316	1097	940	823	731	658	598	548	506	470	439	411
	S	165	256	566	400	300	240	200	171	150	133	120	109	100	92	85	80	75
220	T	865	1339	2961	2194	1645	1316	1097	940	823	731	658	598	548	506	470	439	411
	S	165	256	566	400	300	240	200	171	150	133	120	109	100	92	85	80	75
240	T	865	1339	2961	2194	1645	1316	1097	940	823	731	658	598	548	506	470	439	411
	S	165	256	566	400	300	240	200	171	150	133	120	109	100	92	85	80	75
$k_t \times b (-)$		0,0	15,2	30,5	45,7	61,0	76,2	91,4	106,7	121,9	137,1	152,4	167,6	182,9	198,1	213,3	228,6	243,8

Characteristic load-carrying capacity $F_{4/5,Rk}$ (N) for two angle brackets

b / e (mm)		0	20	40	60	80	100	120	140	160	180	200	220	240	260	280	300	320
0	T	14400	14400	14400	14400	14400	14400	14400	14400	14400	14400	14400	14400	14400	14400	14400	14400	14400
	S	-	-	-	-	-	-	-	-	-	-	-	-	-	-	-	-	-
20	T	14400	14400	7560	5040	3780	3024	2520	2160	1890	1680	1512	1375	1260	1163	1080	1008	945
	S	-	25	12	8	6	5	4	3	3	2	2	2	2	1	1	1	1
40	T	14400	14400	14400	10080	7560	6048	5040	4320	3780	3360	3024	2749	2520	2326	2160	2016	1890
	S	-	51	25	17	12	10	8	7	6	5	5	4	4	3	3	3	3
60	T	14400	14400	14400	14400	11340	9072	7560	6480	5670	5040	4536	4124	3780	3489	3240	3024	2835
	S	-	76	38	25	19	15	12	10	9	8	7	6	6	5	5	5	4
80	T	14400	14400	14400	14400	14400	12096	10080	8640	7560	6720	6048	5498	5040	4652	4320	4032	3780
	S	-	102	51	34	25	20	17	14	12	11	10	9	8	7	7	6	6
100	T	14400	14400	14400	14400	14400	12600	10800	9450	8400	7560	6873	6300	5815	5400	5040	4725	4455
	S	-	127	63	42	31	25	21	18	15	14	12	11	10	9	9	8	7
120	T	14400	14400	14400	14400	14400	14400	12960	11340	10080	9072	8247	7560	6978	6480	6048	5670	5310
	S	-	153	76	51	38	30	25	21	19	17	15	13	12	11	10	10	9
140	T	14400	14400	14400	14400	14400	14400	14400	13230	11760	10584	9622	8820	8142	7560	7056	6615	6225
	S	-	178	89	59	44	35	29	25	22	19	17	16	14	13	12	11	11
160	T	14400	14400	14400	14400	14400	14400	14400	14400	13440	12096	10996	10080	9305	8640	8064	7560	7125
	S	-	204	102	68	51	40	34	29	25	22	20	18	17	15	14	13	12
180	T	14400	14400	14400	14400	14400	14400	14400	14400	14400	14400	13608	12371	11340	10468	9720	9072	8505
	S	-	229	114	76	57	45	38	32	28	25	22	20	19	17	16	15	14
200	T	14400	14400	14400	14400	14400	14400	14400	14400	14400	14400	14400	13745	12600	11631	10800	10080	9450
	S	-	255	127	85	63	51	42	36	31	28	25	23	21	19	18	17	15
220	T	14400	14400	14400	14400	14400	14400	14400	14400	14400	14400	14400	14400	13860	12794	11880	11088	10395
	S	-	280	140	93	70	56	46	40	35	31	28	25	23	21	20	18	17
240	T	14400	14400	14400	14400	14400	14400	14400	14400	14400	14400	14400	14400	14400	13957	12960	12096	11340
	S	-	306	153	102	76	61	51	43	38	34	30	27	25	23	21	20	19
$k_t \times b (-)$		0,0	250,8	501,5	752,3	1003,1	1253,8	1504,6	1755,4	2006,2	2256,9	2507,7	2758,5	3009,2	3260,0	3510,8	3761,5	4012,3

TTM: Timber-Timber-Maximum | TTP: Timber-Timber-Partial | TCM: Timber-Concrete-Maximum | TCP: Timber-Concrete-Partial

T: $F_{1,T,Rk}$ load-carrying capacity of timber | S: $F_{1,S,Rk}$ load-carrying capacity of steel

Table B. 51 Angle bracket type 6503S13, Variant TCM, Fastener GH Nail 4x60, Density 350 kg/m³Characteristic load-carrying capacity $F_{T,Rk}$ (N) for one / two angle brackets

angle bracket		1												2	
f (mm)		0	10	20	30	40	50	60	70	80	90	100	110	120	0
$F_{T,Rk}$	T	18912	8143	4071	2714	2036	1629	1357	1163	1018	905	814	740	679	37824
	S	25	22	20	18	17	15	14	13	12	12	11	10	10	50
$k_t (-)$		12,5	14,1	15,6	17,2	18,7	20,2	21,8	23,3	24,8	26,4	27,9	29,5	31,0	6,3

Characteristic load-carrying capacity $F_{2/3,Rk}$ (N) for one / two angle brackets

angle bracket		1	2
$F_{2/3,Rk}$	T	2760	5520
	S	-	-

Characteristic load-carrying capacity $F_{4,Rk}$ (N) for one angle bracket

e (mm)		0	20	40	60	80	100	120	140	160	180	200	220	240	260	280	300	320
$F_{4,Rk}$	T	-	-	-	23265	3465	1872	1282	975	787	659	567	498	444	400	364	334	309
	S	-	104	52	34	26	20	17	14	13	11	10	9	8	8	7	6	6
$k_t (-)$		0,0	3,1	6,2	9,2	12,3	15,4	18,5	21,5	24,6	27,7	30,8	33,8	36,9	40,0	43,1	46,2	49,2

Characteristic load-carrying capacity $F_{5,Rk}$ (N) for one angle bracket

b / e (mm)		0	20	40	60	80	100	120	140	160	180	200	220	240	260	280	300	320
0	T	1441	2231	4935	3656	2742	2194	1828	1567	1371	1219	1097	997	914	844	783	731	686
	S	165	256	566	400	300	240	200	171	150	133	120	109	100	92	85	80	75
20	T	1441	2231	4935	3656	2742	2194	1828	1567	1371	1219	1097	997	914	844	783	731	686
	S	165	256	566	400	300	240	200	171	150	133	120	109	100	92	85	80	75
40	T	1441	2231	4935	3656	2742	2194	1828	1567	1371	1219	1097	997	914	844	783	731	686
	S	165	256	566	400	300	240	200	171	150	133	120	109	100	92	85	80	75
60	T	1441	2231	4935	3656	2742	2194	1828	1567	1371	1219	1097	997	914	844	783	731	686
	S	165	256	566	400	300	240	200	171	150	133	120	109	100	92	85	80	75
80	T	1441	2231	4935	3656	2742	2194	1828	1567	1371	1219	1097	997	914	844	783	731	686
	S	165	256	566	400	300	240	200	171	150	133	120	109	100	92	85	80	75
100	T	1441	2231	4935	3656	2742	2194	1828	1567	1371	1219	1097	997	914	844	783	731	686
	S	165	256	566	400	300	240	200	171	150	133	120	109	100	92	85	80	75
120	T	1441	2231	4935	3656	2742	2194	1828	1567	1371	1219	1097	997	914	844	783	731	686
	S	165	256	566	400	300	240	200	171	150	133	120	109	100	92	85	80	75
140	T	1441	2231	4935	3656	2742	2194	1828	1567	1371	1219	1097	997	914	844	783	731	686
	S	165	256	566	400	300	240	200	171	150	133	120	109	100	92	85	80	75
160	T	1441	2231	4935	3656	2742	2194	1828	1567	1371	1219	1097	997	914	844	783	731	686
	S	165	256	566	400	300	240	200	171	150	133	120	109	100	92	85	80	75
180	T	1441	2231	4935	3656	2742	2194	1828	1567	1371	1219	1097	997	914	844	783	731	686
	S	165	256	566	400	300	240	200	171	150	133	120	109	100	92	85	80	75
200	T	1441	2231	4935	3656	2742	2194	1828	1567	1371	1219	1097	997	914	844	783	731	686
	S	165	256	566	400	300	240	200	171	150	133	120	109	100	92	85	80	75
220	T	1441	2231	4935	3656	2742	2194	1828	1567	1371	1219	1097	997	914	844	783	731	686
	S	165	256	566	400	300	240	200	171	150	133	120	109	100	92	85	80	75
240	T	1441	2231	4935	3656	2742	2194	1828	1567	1371	1219	1097	997	914	844	783	731	686
	S	165	256	566	400	300	240	200	171	150	133	120	109	100	92	85	80	75
$k_t \times b (-)$		0,0	15,2	30,5	45,7	61,0	76,2	91,4	106,7	121,9	137,1	152,4	167,6	182,9	198,1	213,3	228,6	243,8

Characteristic load-carrying capacity $F_{4/5,Rk}$ (N) for two angle brackets

b / e (mm)		0	20	40	60	80	100	120	140	160	180	200	220	240	260	280	300	320
0	T	23999	23999	23999	23999	23999	23999	23999	23999	23999	23999	23999	23999	23999	23999	23999	23999	23999
	S	-	-	-	-	-	-	-	-	-	-	-	-	-	-	-	-	-
20	T	23999	18912	9456	6304	4728	3782	3152	2702	2364	2101	1891	1719	1576	1455	1351	1261	1182
	S	-	25	12	8	6	5	4	3	3	2	2	2	2	1	1	1	1
40	T	23999	24000	18912	12608	9456	7565	6304	5403	4728	4203	3782	3439	3152	2910	2702	2522	2364
	S	-	51	25	17	12	10	8	7	6	5	5	4	4	3	3	3	3
60	T	23999	24000	24000	18912	14184	11347	9456	8105	7092	6304	5674	5158	4728	4364	4053	3782	3546
	S	-	76	38	25	19	15	12	10	9	8	7	6	6	5	5	5	4
80	T	23999	24000	24000	24000	18912	15130	12608	10807	9456	8405	7565	6877	6304	5819	5403	5043	4728
	S	-	102	51	34	25	20	17	14	12	11	10	9	8	7	7	6	6
100	T	23999	24000	24000	24000	23640	18912	15760	13509	11820	10507	9456	8596	7880	7274	6754	6304	5910
	S	-	127	63	42	31	25	21	18	15	14	12	11	10	9	9	8	7
120	T	23999	24000	24000	24000	24000	22694	18912	16210	14184	12608	11347	10316	9456	8729	8105	7565	7092
	S	-	153	76	51	38	30	25	21	19	17	15	13	12	11	10	10	9
140	T	23999	24000	24000	24000	24000	22064	18912	16548	14709	13238	12035	11032	10183	9456	8826	8274	
	S	-	178	89	59	44	35	29	25	22	19	17	16	14	13	12	11	11
160	T	23999	24000	24000	24000	24000	24000	21614	18912	16811	15130	13754	12608	11638	10807	10086	9456	
	S	-	204	102	68	51	40	34	29	25	22	20	18	17	15	14	13	12
180	T	23999	24000	24000	24000	24000	24000	24000	21276	18912	17021	15473	14184	13093	12158	11347	10638	
	S	-	229	114	76	57	45	38	32	28	25	22	20	19	17	16	15	14
200	T	23999	24000	24000	24000	24000	24000	24000	23640	21013	18912	17193	15760	14548	13509	12608	11820	
	S	-	255	127	85	63	51	42	36	31	28	25	23	21	19	18	17	15
220	T	23999	24000	24000	24000	24000	24000	24000	24000	23115	20803	18912	17336	16002	14859	13869	13002	
	S	-	280	140	93	70	56	46	40	35	31	28	25	23	21	20	18	17
240	T	23999	24000	24000	24000	24000	24000	24000	24000	24000	24000	22694	20631	18912	17457	16210	15130	14184
	S	-	306	153	102	76	61	51	43	38	34	30	27	25	23	21	20	19
$k_t \times b (-)$		0,0	250,8	501,5	752,3	1003,1	1253,8	1504,6	1755,4	2006,2	2256,9	2507,7	2758,5	3009,2	3260,0	3510,8	3761,5	4012,3

TTM: Timber-Timber-Maximum | TTP: Timber-Timber-Partial | TCM: Timber-Concrete-Maximum | TCP: Timber-Concrete-Partial

T: $F_{T,Rk}$ load-carrying capacity of timber | S: $F_{S,Rk}$ load-carrying capacity of steel

Table B. 52 Angle bracket type 6503S13, Variant TCM, Fastener GH Screw 5x40, Density 350 kg/m³Characteristic load-carrying capacity $F_{1,Rk}$ (N) for one / two angle brackets

angle bracket		1													2
f (mm)		0	10	20	30	40	50	60	70	80	90	100	110	120	0
$F_{1,Rk}$	T	16024	10260	5130	3420	2565	2052	1710	1466	1283	1140	1026	933	855	32048
	S	25	22	20	18	17	15	14	13	12	12	11	10	10	50
k_t (-)		12,5	14,1	15,6	17,2	18,7	20,2	21,8	23,3	24,8	26,4	27,9	29,5	31,0	6,3

Characteristic load-carrying capacity $F_{2/3,Rk}$ (N) for one / two angle brackets

angle bracket		1	2
$F_{2/3,Rk}$	T	3020	6040
	S	-	-

Characteristic load-carrying capacity $F_{4,Rk}$ (N) for one angle bracket

e (mm)		0	20	40	60	80	100	120	140	160	180	200	220	240	260	280	300	320
$F_{4,Rk}$	T	-	-	-	29314	4366	2359	1616	1229	991	831	715	628	559	504	459	421	389
	S	-	104	52	34	26	20	17	14	13	11	10	9	8	8	7	6	6
k_t (-)		0,0	3,1	6,2	9,2	12,3	15,4	18,5	21,5	24,6	27,7	30,8	33,8	36,9	40,0	43,1	46,2	49,2

Characteristic load-carrying capacity $F_{5,Rk}$ (N) for one angle bracket

b / e (mm)		0	20	40	60	80	100	120	140	160	180	200	220	240	260	280	300	320
0	T	1816	2811	6218	4607	3455	2764	2303	1974	1727	1536	1382	1256	1152	1063	987	921	864
	S	165	256	566	400	300	240	200	171	150	133	120	109	100	92	85	80	75
20	T	1816	2811	6218	4607	3455	2764	2303	1974	1727	1536	1382	1256	1152	1063	987	921	864
	S	165	256	566	400	300	240	200	171	150	133	120	109	100	92	85	80	75
40	T	1816	2811	6218	4607	3455	2764	2303	1974	1727	1536	1382	1256	1152	1063	987	921	864
	S	165	256	566	400	300	240	200	171	150	133	120	109	100	92	85	80	75
60	T	1816	2811	6218	4607	3455	2764	2303	1974	1727	1536	1382	1256	1152	1063	987	921	864
	S	165	256	566	400	300	240	200	171	150	133	120	109	100	92	85	80	75
80	T	1816	2811	6218	4607	3455	2764	2303	1974	1727	1536	1382	1256	1152	1063	987	921	864
	S	165	256	566	400	300	240	200	171	150	133	120	109	100	92	85	80	75
100	T	1816	2811	6218	4607	3455	2764	2303	1974	1727	1536	1382	1256	1152	1063	987	921	864
	S	165	256	566	400	300	240	200	171	150	133	120	109	100	92	85	80	75
120	T	1816	2811	6218	4607	3455	2764	2303	1974	1727	1536	1382	1256	1152	1063	987	921	864
	S	165	256	566	400	300	240	200	171	150	133	120	109	100	92	85	80	75
140	T	1816	2811	6218	4607	3455	2764	2303	1974	1727	1536	1382	1256	1152	1063	987	921	864
	S	165	256	566	400	300	240	200	171	150	133	120	109	100	92	85	80	75
160	T	1816	2811	6218	4607	3455	2764	2303	1974	1727	1536	1382	1256	1152	1063	987	921	864
	S	165	256	566	400	300	240	200	171	150	133	120	109	100	92	85	80	75
180	T	1816	2811	6218	4607	3455	2764	2303	1974	1727	1536	1382	1256	1152	1063	987	921	864
	S	165	256	566	400	300	240	200	171	150	133	120	109	100	92	85	80	75
200	T	1816	2811	6218	4607	3455	2764	2303	1974	1727	1536	1382	1256	1152	1063	987	921	864
	S	165	256	566	400	300	240	200	171	150	133	120	109	100	92	85	80	75
220	T	1816	2811	6218	4607	3455	2764	2303	1974	1727	1536	1382	1256	1152	1063	987	921	864
	S	165	256	566	400	300	240	200	171	150	133	120	109	100	92	85	80	75
240	T	1816	2811	6218	4607	3455	2764	2303	1974	1727	1536	1382	1256	1152	1063	987	921	864
	S	165	256	566	400	300	240	200	171	150	133	120	109	100	92	85	80	75
$k_t \times b$ (-)		0,0	15,2	30,5	45,7	61,0	76,2	91,4	106,7	121,9	137,1	152,4	167,6	182,9	198,1	213,3	228,6	243,8

Characteristic load-carrying capacity $F_{4/5,Rk}$ (N) for two angle brackets

b / e (mm)		0	20	40	60	80	100	120	140	160	180	200	220	240	260	280	300	320
0	T	30239	30239	30239	30239	30239	30239	30239	30239	30239	30239	30239	30239	30239	30239	30239	30239	30239
	S	-	-	-	-	-	-	-	-	-	-	-	-	-	-	-	-	-
20	T	30239	16024	8012	5341	4006	3205	2671	2289	2003	1780	1602	1457	1335	1233	1145	1068	1002
	S	-	25	12	8	6	5	4	3	3	2	2	2	2	1	1	1	1
40	T	30239	30240	16024	10683	8012	6410	5341	4578	4006	3561	3205	2913	2671	2465	2289	2137	2003
	S	-	51	25	17	12	10	8	7	6	5	5	4	4	3	3	3	3
60	T	30239	30240	24036	16024	12018	9614	8012	6867	6009	5341	4807	4370	4006	3698	3434	3205	3005
	S	-	76	38	25	19	15	12	10	9	8	7	6	6	5	5	5	4
80	T	30239	30240	30240	21365	16024	12819	10683	9157	8012	7122	6410	5827	5341	4930	4578	4273	4006
	S	-	102	51	34	25	20	17	14	12	11	10	9	8	7	7	6	6
100	T	30239	30240	30240	26707	20030	16024	13353	11446	10015	8902	8012	7284	6677	6163	5723	5341	5008
	S	-	127	63	42	31	25	21	18	15	14	12	11	10	9	9	8	7
120	T	30239	30240	30240	30240	24036	19229	16024	13735	12018	10683	9614	8740	8012	7396	6867	6410	6009
	S	-	153	76	51	38	30	25	21	19	17	15	13	12	11	10	10	9
140	T	30239	30240	30240	30240	28042	22434	18695	16024	14021	12463	11217	10197	9347	8628	8012	7478	7011
	S	-	178	89	59	44	35	29	25	22	19	17	16	14	13	12	11	11
160	T	30239	30240	30240	30240	30240	25638	21365	18313	16024	14244	12819	11654	10683	9861	9157	8546	8012
	S	-	204	102	68	51	40	34	29	25	22	20	18	17	15	14	13	12
180	T	30239	30240	30240	30240	30240	28843	24036	20602	18027	16024	14422	13111	12018	11094	10301	9614	9014
	S	-	229	114	76	57	45	38	32	28	25	22	20	19	17	16	15	14
200	T	30239	30240	30240	30240	30240	26707	22891	20030	17804	16024	14567	13353	12326	11446	10683	10015	10015
	S	-	255	127	85	63	51	42	36	31	28	25	23	21	19	18	17	15
220	T	30239	30240	30240	30240	30240	29377	25181	22033	19585	17626	16024	14689	13559	12590	11751	11017	11017
	S	-	280	140	93	70	56	46	40	35	31	28	25	23	21	20	18	17
240	T	30239	30240	30240	30240	30240	30240	27470	24036	21365	19229	17481	16024	14791	13735	12819	12018	12018
	S	-	306	153	102	76	61	51	43	38	34	30	27	25	23	21	20	19
$k_t \times b$ (-)		0,0	250,8	501,5	752,3	1003,1	1253,8	1504,6	1755,4	2006,2	2256,9	2507,7	2758,5	3009,2	3260,0	3510,8	3761,5	4012,3

TTM: Timber-Timber-Maximum | TTP: Timber-Timber-Partial | TCM: Timber-Concrete-Maximum | TCP: Timber-Concrete-Partial

T: $F_{T,Rk}$ load-carrying capacity of timber | S: $F_{S,Rk}$ load-carrying capacity of steel

Table B. 53 Angle bracket type 6503S13, Variant TCM, Fastener GH Screw 5x60, Density 350 kg/m³Characteristic load-carrying capacity $F_{T,Rk}$ (N) for one / two angle brackets

angle bracket		1												2	
f (mm)		0	10	20	30	40	50	60	70	80	90	100	110	120	0
$F_{T,Rk}$	T	18120	15960	7980	5320	3990	3192	2660	2280	1995	1773	1596	1451	1330	36240
	S	25	22	20	18	17	15	14	13	12	12	11	10	10	50
$k_t (-)$		12,5	14,1	15,6	17,2	18,7	20,2	21,8	23,3	24,8	26,4	27,9	29,5	31,0	6,3

Characteristic load-carrying capacity $F_{2/3,Rk}$ (N) for one / two angle brackets

angle bracket		1	2
$F_{2/3,Rk}$	T	3960	7920
	S	-	-

Characteristic load-carrying capacity $F_{4,Rk}$ (N) for one angle bracket

e (mm)		0	20	40	60	80	100	120	140	160	180	200	220	240	260	280	300	320
$F_{4,Rk}$	T	-	-	-	45600	6791	3669	2513	1911	1542	1292	1112	976	870	784	714	655	606
	S	-	104	52	34	26	20	17	14	13	11	10	9	8	8	7	6	6
$k_t (-)$		0,0	3,1	6,2	9,2	12,3	15,4	18,5	21,5	24,6	27,7	30,8	33,8	36,9	40,0	43,1	46,2	49,2

Characteristic load-carrying capacity $F_{5,Rk}$ (N) for one angle bracket

b / e (mm)		0	20	40	60	80	100	120	140	160	180	200	220	240	260	280	300	320
0	T	2825	4373	9673	7166	5374	4299	3583	3071	2687	2389	2150	1954	1791	1654	1536	1433	1344
	S	165	256	566	400	300	240	200	171	150	133	120	109	100	92	85	80	75
20	T	2825	4373	9673	6040	4530	3624	3020	2589	2265	2013	1812	1647	1510	1394	1294	1208	1133
	S	165	256	566	400	300	240	200	171	150	133	120	109	100	92	85	80	75
40	T	2825	4373	9673	7166	5374	4299	3583	3071	2687	2389	2150	1954	1791	1654	1536	1433	1344
	S	165	256	566	400	300	240	200	171	150	133	120	109	100	92	85	80	75
60	T	2825	4373	9673	7166	5374	4299	3583	3071	2687	2389	2150	1954	1791	1654	1536	1433	1344
	S	165	256	566	400	300	240	200	171	150	133	120	109	100	92	85	80	75
80	T	2825	4373	9673	7166	5374	4299	3583	3071	2687	2389	2150	1954	1791	1654	1536	1433	1344
	S	165	256	566	400	300	240	200	171	150	133	120	109	100	92	85	80	75
100	T	2825	4373	9673	7166	5374	4299	3583	3071	2687	2389	2150	1954	1791	1654	1536	1433	1344
	S	165	256	566	400	300	240	200	171	150	133	120	109	100	92	85	80	75
120	T	2825	4373	9673	7166	5374	4299	3583	3071	2687	2389	2150	1954	1791	1654	1536	1433	1344
	S	165	256	566	400	300	240	200	171	150	133	120	109	100	92	85	80	75
140	T	2825	4373	9673	7166	5374	4299	3583	3071	2687	2389	2150	1954	1791	1654	1536	1433	1344
	S	165	256	566	400	300	240	200	171	150	133	120	109	100	92	85	80	75
160	T	2825	4373	9673	7166	5374	4299	3583	3071	2687	2389	2150	1954	1791	1654	1536	1433	1344
	S	165	256	566	400	300	240	200	171	150	133	120	109	100	92	85	80	75
180	T	2825	4373	9673	7166	5374	4299	3583	3071	2687	2389	2150	1954	1791	1654	1536	1433	1344
	S	165	256	566	400	300	240	200	171	150	133	120	109	100	92	85	80	75
200	T	2825	4373	9673	7166	5374	4299	3583	3071	2687	2389	2150	1954	1791	1654	1536	1433	1344
	S	165	256	566	400	300	240	200	171	150	133	120	109	100	92	85	80	75
220	T	2825	4373	9673	7166	5374	4299	3583	3071	2687	2389	2150	1954	1791	1654	1536	1433	1344
	S	165	256	566	400	300	240	200	171	150	133	120	109	100	92	85	80	75
240	T	2825	4373	9673	7166	5374	4299	3583	3071	2687	2389	2150	1954	1791	1654	1536	1433	1344
	S	165	256	566	400	300	240	200	171	150	133	120	109	100	92	85	80	75
$k_t \times b (-)$		0,0	15,2	30,5	45,7	61,0	76,2	91,4	106,7	121,9	137,1	152,4	167,6	182,9	198,1	213,3	228,6	243,8

Characteristic load-carrying capacity $F_{4/5,Rk}$ (N) for two angle brackets

b / e (mm)		0	20	40	60	80	100	120	140	160	180	200	220	240	260	280	300	320
0	T	47040	47040	47040	47040	47040	47040	47040	47040	47040	47040	47040	47040	47040	47040	47040	47040	47040
	S	-	-	-	-	-	-	-	-	-	-	-	-	-	-	-	-	-
20	T	47040	18120	9060	6040	4530	3624	3020	2589	2265	2013	1812	1647	1510	1394	1294	1208	1133
	S	-	25	12	8	6	5	4	3	3	2	2	2	2	1	1	1	1
40	T	47040	36240	18120	12080	9060	7248	6040	5177	4530	4027	3624	3295	3020	2788	2589	2416	2265
	S	-	51	25	17	12	10	8	7	6	5	5	4	4	3	3	3	3
60	T	47040	47040	27180	18120	13590	10872	9060	7766	6795	6040	5436	4942	4530	4182	3883	3624	3398
	S	-	76	38	25	19	15	12	10	9	8	7	6	6	5	5	5	4
80	T	47040	47040	36240	24160	18120	14496	12080	10354	9060	8053	7248	6589	6040	5575	5177	4832	4530
	S	-	102	51	34	25	20	17	14	12	11	10	9	8	7	7	6	6
100	T	47040	47040	45300	30200	22650	18120	15100	12943	11325	10067	9060	8236	7550	6969	6471	6040	5663
	S	-	127	63	42	31	25	21	18	15	14	12	11	10	9	9	8	7
120	T	47040	47040	47040	36240	27180	21744	18120	15531	13590	12080	10872	9884	9060	8363	7766	7248	6795
	S	-	153	76	51	38	30	25	21	19	17	15	13	12	11	10	10	9
140	T	47040	47040	47040	42280	31710	25368	21140	18120	15855	14093	12684	11531	10570	9757	9060	8456	7928
	S	-	178	89	59	44	35	29	25	22	19	17	16	14	13	12	11	11
160	T	47040	47040	47040	47040	36240	28992	24160	20709	18120	16107	14496	13178	12080	11151	10354	9664	9060
	S	-	204	102	68	51	40	34	29	25	22	20	18	17	15	14	13	12
180	T	47040	47040	47040	47040	40770	32616	27180	23297	20385	18120	16308	14825	13590	12545	11649	10872	10193
	S	-	229	114	76	57	45	38	32	28	25	22	20	19	17	16	15	14
200	T	47040	47040	47040	47040	45300	36240	30200	25886	22650	20133	18120	16473	15100	13938	12943	12080	11325
	S	-	255	127	85	63	51	42	36	31	28	25	23	21	19	18	17	15
220	T	47040	47040	47040	47040	47040	39864	33220	28474	24915	22147	19932	18120	16610	15332	14237	13288	12458
	S	-	280	140	93	70	56	46	40	35	31	28	25	23	21	20	18	17
240	T	47040	47040	47040	47040	47040	43488	36240	31063	27180	24160	21744	19767	18120	16726	15531	14496	13590
	S	-	306	153	102	76	61	51	43	38	34	30	27	25	23	21	20	19
$k_t \times b (-)$		0,0	250,8	501,5	752,3	1003,1	1253,8	1504,6	1755,4	2006,2	2256,9	2507,7	2758,5	3009,2	3260,0	3510,8	3761,5	4012,3

TTM: Timber-Timber-Maximum | TTP: Timber-Timber-Partial | TCM: Timber-Concrete-Maximum | TCP: Timber-Concrete-Partial

T: $F_{T,Rk}$ load-carrying capacity of timber | S: $F_{S,Rk}$ load-carrying capacity of steel

Table B. 54 Angle bracket type 6503S13, Variant TCP, Fastener GH Nail 4x40, Density 350 kg/m³

Characteristic load-carrying capacity $F_{1,Rk}$ (N) for one / two angle brackets															
angle bracket	1													2	
f (mm)	0	10	20	30	40	50	60	70	80	90	100	110	120	0	
$F_{1,Rk}$	T	7560	4050	2025	1350	1013	810	675	579	506	450	405	368	338	15120
	S	25	22	20	18	17	15	14	13	12	11	10	10	10	50
k_t (-)	12,5	14,1	15,6	17,2	18,7	20,2	21,8	23,3	24,8	26,4	27,9	29,5	31,0	6,3	

Characteristic load-carrying capacity $F_{2/3,Rk}$ (N) for one / two angle brackets			
angle bracket	1	2	
$F_{2/3,Rk}$	T	920	1840
	S	-	-

Characteristic load-carrying capacity $F_{4,Rk}$ (N) for one angle bracket																		
e (mm)	0	20	40	60	80	100	120	140	160	180	200	220	240	260	280	300	320	
$F_{4,Rk}$	T	-	-	-	11571	1723	931	638	485	391	328	282	248	221	199	181	166	154
	S	-	104	52	34	26	20	17	14	13	11	10	9	8	8	7	6	6
k_t (-)	0,0	3,1	6,2	9,2	12,3	15,4	18,5	21,5	24,6	27,7	30,8	33,8	36,9	40,0	43,1	46,2	49,2	

Characteristic load-carrying capacity $F_{5,Rk}$ (N) for one angle bracket																		
b / e (mm)	0	20	40	60	80	100	120	140	160	180	200	220	240	260	280	300	320	
0	T	717	1110	2455	1020	765	612	510	437	383	340	306	278	255	235	219	204	191
	S	281	435	600	400	300	240	200	171	150	133	120	109	100	92	85	80	75
20	T	717	1110	2455	1020	765	612	510	437	383	340	306	278	255	235	219	204	191
	S	281	435	600	400	300	240	200	171	150	133	120	109	100	92	85	80	75
40	T	717	1110	2455	1020	765	612	510	437	383	340	306	278	255	235	219	204	191
	S	281	435	600	400	300	240	200	171	150	133	120	109	100	92	85	80	75
60	T	717	1110	2455	1020	765	612	510	437	383	340	306	278	255	235	219	204	191
	S	281	435	600	400	300	240	200	171	150	133	120	109	100	92	85	80	75
80	T	717	1110	2455	1020	765	612	510	437	383	340	306	278	255	235	219	204	191
	S	281	435	600	400	300	240	200	171	150	133	120	109	100	92	85	80	75
100	T	717	1110	2455	1020	765	612	510	437	383	340	306	278	255	235	219	204	191
	S	281	435	600	400	300	240	200	171	150	133	120	109	100	92	85	80	75
120	T	717	1110	2455	1020	765	612	510	437	383	340	306	278	255	235	219	204	191
	S	281	435	600	400	300	240	200	171	150	133	120	109	100	92	85	80	75
140	T	717	1110	2455	1020	765	612	510	437	383	340	306	278	255	235	219	204	191
	S	281	435	600	400	300	240	200	171	150	133	120	109	100	92	85	80	75
160	T	717	1110	2455	1020	765	612	510	437	383	340	306	278	255	235	219	204	191
	S	281	435	600	400	300	240	200	171	150	133	120	109	100	92	85	80	75
180	T	717	1110	2455	1020	765	612	510	437	383	340	306	278	255	235	219	204	191
	S	281	435	600	400	300	240	200	171	150	133	120	109	100	92	85	80	75
200	T	717	1110	2455	1020	765	612	510	437	383	340	306	278	255	235	219	204	191
	S	281	435	600	400	300	240	200	171	150	133	120	109	100	92	85	80	75
220	T	717	1110	2455	1020	765	612	510	437	383	340	306	278	255	235	219	204	191
	S	281	435	600	400	300	240	200	171	150	133	120	109	100	92	85	80	75
240	T	717	1110	2455	1020	765	612	510	437	383	340	306	278	255	235	219	204	191
	S	281	435	600	400	300	240	200	171	150	133	120	109	100	92	85	80	75
$k_t \times b$ (-)	0,0	15,2	30,5	45,7	61,0	76,2	91,4	106,7	121,9	137,1	152,4	167,6	182,9	198,1	213,3	228,6	243,8	

Characteristic load-carrying capacity $F_{4/5,Rk}$ (N) for two angle brackets																		
b / e (mm)	0	20	40	60	80	100	120	140	160	180	200	220	240	260	280	300	320	
0	T	7199	7199	7199	7199	7199	7199	7199	7199	7199	7199	7199	7199	7199	7199	7199	7199	
	S	-	-	-	-	-	-	-	-	-	-	-	-	-	-	-	-	
20	T	7199	7200	3780	2520	1890	1512	1260	1080	945	840	756	687	630	582	540	504	473
	S	-	25	12	8	6	5	4	3	3	2	2	2	2	1	1	1	1
40	T	7199	7200	7200	5040	3780	3024	2520	2160	1890	1680	1512	1375	1260	1163	1080	1008	945
	S	-	51	25	17	12	10	8	7	6	5	5	4	4	3	3	3	3
60	T	7199	7200	7200	7200	5670	4536	3780	3240	2835	2520	2268	2062	1890	1745	1620	1512	1418
	S	-	76	38	25	19	15	12	10	9	8	7	6	6	5	5	5	4
80	T	7199	7200	7200	7200	7200	6048	5040	4320	3780	3360	3024	2749	2520	2326	2160	2016	1890
	S	-	102	51	34	25	20	17	14	12	11	10	9	8	7	7	6	6
100	T	7199	7200	7200	7200	7200	6300	5400	4725	4200	3780	3436	3150	2908	2700	2520	2363	2363
	S	-	127	63	42	31	25	21	18	15	14	12	11	10	9	9	8	7
120	T	7199	7200	7200	7200	7200	7200	6480	5670	5040	4536	4124	3780	3489	3240	3024	2835	2835
	S	-	153	76	51	38	30	25	21	19	17	15	13	12	11	10	10	9
140	T	7199	7200	7200	7200	7200	7200	7200	6615	5880	5292	4811	4410	4071	3780	3528	3308	3308
	S	-	178	89	59	44	35	29	25	22	19	17	16	14	13	12	11	11
160	T	7199	7200	7200	7200	7200	7200	7200	7200	6720	6048	5498	5040	4652	4320	4032	3780	3780
	S	-	204	102	68	51	40	34	29	25	22	20	18	17	15	14	13	12
180	T	7199	7200	7200	7200	7200	7200	7200	7200	7200	7200	6804	6185	5670	5234	4860	4536	4253
	S	-	229	114	76	57	45	38	32	28	25	22	20	19	17	16	15	14
200	T	7199	7200	7200	7200	7200	7200	7200	7200	7200	7200	7200	6873	6300	5815	5400	5040	4725
	S	-	255	127	85	63	51	42	36	31	28	25	23	21	19	18	17	15
220	T	7199	7200	7200	7200	7200	7200	7200	7200	7200	7200	7200	7200	6930	6397	5940	5544	5198
	S	-	280	140	93	70	56	46	40	35	31	28	25	23	21	20	18	17
240	T	7199	7200	7200	7200	7200	7200	7200	7200	7200	7200	7200	7200	7200	6978	6480	6048	5670
	S	-	306	153	102	76	61	51	43	38	34	30	27	25	23	21	20	19
$k_t \times b$ (-)	0,0	250,8	501,5	752,3	1003,1	1253,8	1504,6	1755,4	2006,2	2256,9	2507,7	2758,5	3009,2	3260,0	3510,8	3761,5	4012,3	

TTM: Timber-Timber-Maximum | TTP: Timber-Timber-Partial | TCM: Timber-Concrete-Maximum | TCP: Timber-Concrete-Partial

T: $F_{1,T,Rk}$ load-carrying capacity of timber | S: $F_{1,S,Rk}$ load-carrying capacity of steel

Table B. 55 Angle bracket type 6503S13, Variant TCP, Fastener GH Nail 4x60, Density 350 kg/m³Characteristic load-carrying capacity $F_{1,Rk}$ (N) for one / two angle brackets

angle bracket		1												2	
f (mm)		0	10	20	30	40	50	60	70	80	90	100	110	120	0
$F_{1,Rk}$	T	9456	6750	3375	2250	1688	1350	1125	964	844	750	675	614	563	18912
	S	25	22	20	18	17	15	14	13	12	12	11	10	10	50
$k_t (-)$		12,5	14,1	15,6	17,2	18,7	20,2	21,8	23,3	24,8	26,4	27,9	29,5	31,0	6,3

Characteristic load-carrying capacity $F_{2/3,Rk}$ (N) for one / two angle brackets

angle bracket		1	2
$F_{2/3,Rk}$	T	1470	2940
	S	-	-

Characteristic load-carrying capacity $F_{4,Rk}$ (N) for one angle bracket

e (mm)		0	20	40	60	80	100	120	140	160	180	200	220	240	260	280	300	320
$F_{4,Rk}$	T	-	-	-	19286	2872	1552	1063	808	652	547	470	413	368	332	302	277	256
	S	-	104	52	34	26	20	17	14	13	11	10	9	8	8	7	6	6
$k_t (-)$		0,0	3,1	6,2	9,2	12,3	15,4	18,5	21,5	24,6	27,7	30,8	33,8	36,9	40,0	43,1	46,2	49,2

Characteristic load-carrying capacity $F_{5,Rk}$ (N) for one angle bracket

b / e (mm)		0	20	40	60	80	100	120	140	160	180	200	220	240	260	280	300	320
0	T	1195	1849	4091	1700	1275	1020	850	729	638	567	510	464	425	392	364	340	319
	S	281	435	600	400	300	240	200	171	150	133	120	109	100	92	85	80	75
20	T	1195	1849	4091	1700	1275	1020	850	729	638	567	510	464	425	392	364	340	319
	S	281	435	600	400	300	240	200	171	150	133	120	109	100	92	85	80	75
40	T	1195	1849	4091	1700	1275	1020	850	729	638	567	510	464	425	392	364	340	319
	S	281	435	600	400	300	240	200	171	150	133	120	109	100	92	85	80	75
60	T	1195	1849	4091	1700	1275	1020	850	729	638	567	510	464	425	392	364	340	319
	S	281	435	600	400	300	240	200	171	150	133	120	109	100	92	85	80	75
80	T	1195	1849	4091	1700	1275	1020	850	729	638	567	510	464	425	392	364	340	319
	S	281	435	600	400	300	240	200	171	150	133	120	109	100	92	85	80	75
100	T	1195	1849	4091	1700	1275	1020	850	729	638	567	510	464	425	392	364	340	319
	S	281	435	600	400	300	240	200	171	150	133	120	109	100	92	85	80	75
120	T	1195	1849	4091	1700	1275	1020	850	729	638	567	510	464	425	392	364	340	319
	S	281	435	600	400	300	240	200	171	150	133	120	109	100	92	85	80	75
140	T	1195	1849	4091	1700	1275	1020	850	729	638	567	510	464	425	392	364	340	319
	S	281	435	600	400	300	240	200	171	150	133	120	109	100	92	85	80	75
160	T	1195	1849	4091	1700	1275	1020	850	729	638	567	510	464	425	392	364	340	319
	S	281	435	600	400	300	240	200	171	150	133	120	109	100	92	85	80	75
180	T	1195	1849	4091	1700	1275	1020	850	729	638	567	510	464	425	392	364	340	319
	S	281	435	600	400	300	240	200	171	150	133	120	109	100	92	85	80	75
200	T	1195	1849	4091	1700	1275	1020	850	729	638	567	510	464	425	392	364	340	319
	S	281	435	600	400	300	240	200	171	150	133	120	109	100	92	85	80	75
220	T	1195	1849	4091	1700	1275	1020	850	729	638	567	510	464	425	392	364	340	319
	S	281	435	600	400	300	240	200	171	150	133	120	109	100	92	85	80	75
240	T	1195	1849	4091	1700	1275	1020	850	729	638	567	510	464	425	392	364	340	319
	S	281	435	600	400	300	240	200	171	150	133	120	109	100	92	85	80	75
$k_t \times b (-)$		0,0	15,2	30,5	45,7	61,0	76,2	91,4	106,7	121,9	137,1	152,4	167,6	182,9	198,1	213,3	228,6	243,8

Characteristic load-carrying capacity $F_{4/5,Rk}$ (N) for two angle brackets

b / e (mm)		0	20	40	60	80	100	120	140	160	180	200	220	240	260	280	300	320
0	T	12000	12000	12000	12000	12000	12000	12000	12000	12000	12000	12000	12000	12000	12000	12000	12000	12000
	S	-	-	-	-	-	-	-	-	-	-	-	-	-	-	-	-	-
20	T	12000	9456	4728	3152	2364	1891	1576	1351	1182	1051	946	860	788	727	675	630	591
	S	-	25	12	8	6	5	4	3	3	2	2	2	2	1	1	1	1
40	T	12000	12000	9456	6304	4728	3782	3152	2702	2364	2101	1891	1719	1576	1455	1351	1261	1182
	S	-	51	25	17	12	10	8	7	6	5	5	4	4	3	3	3	3
60	T	12000	12000	12000	9456	7092	5674	4728	4053	3546	3152	2837	2579	2364	2182	2026	1891	1773
	S	-	76	38	25	19	15	12	10	9	8	7	6	6	5	5	5	4
80	T	12000	12000	12000	12000	9456	7565	6304	5403	4728	4203	3782	3439	3152	2910	2702	2522	2364
	S	-	102	51	34	25	20	17	14	12	11	10	9	8	7	7	6	6
100	T	12000	12000	12000	12000	11820	9456	7880	6754	5910	5253	4728	4298	3940	3637	3377	3152	2955
	S	-	127	63	42	31	25	21	18	15	14	12	11	10	9	9	8	7
120	T	12000	12000	12000	12000	11347	9456	8105	7092	6304	5674	5158	4728	4364	4053	3782	3546	3346
	S	-	153	76	51	38	30	25	21	19	17	15	13	12	11	10	10	9
140	T	12000	12000	12000	12000	12000	11032	9456	8274	7355	6619	6017	5516	5092	4728	4413	4137	3937
	S	-	178	89	59	44	35	29	25	22	19	17	16	14	13	12	11	11
160	T	12000	12000	12000	12000	12000	12000	10807	9456	8405	7565	6877	6304	5819	5403	5043	4728	4478
	S	-	204	102	68	51	40	34	29	25	22	20	18	17	15	14	13	12
180	T	12000	12000	12000	12000	12000	12000	12000	10638	9456	8510	7737	7092	6546	6079	5674	5319	5019
	S	-	229	114	76	57	45	38	32	28	25	22	20	19	17	16	15	14
200	T	12000	12000	12000	12000	12000	12000	12000	11820	10507	9456	8596	7880	7274	6754	6304	5910	5510
	S	-	255	127	85	63	51	42	36	31	28	25	23	21	19	18	17	15
220	T	12000	12000	12000	12000	12000	12000	12000	12000	11557	10402	9456	8668	8001	7430	6934	6501	6101
	S	-	280	140	93	70	56	46	40	35	31	28	25	23	21	20	18	17
240	T	12000	12000	12000	12000	12000	12000	12000	12000	12000	12000	11347	10316	9456	8729	8105	7565	7092
	S	-	306	153	102	76	61	51	43	38	34	30	27	25	23	21	20	19
$k_t \times b (-)$		0,0	250,8	501,5	752,3	1003,1	1253,8	1504,6	1755,4	2006,2	2256,9	2507,7	2758,5	3009,2	3260,0	3510,8	3761,5	4012,3

TTM: Timber-Timber-Maximum | TTP: Timber-Timber-Partial | TCM: Timber-Concrete-Maximum | TCP: Timber-Concrete-Partial

T: $F_{1,T,Rk}$ load-carrying capacity of timber | S: $F_{1,S,Rk}$ load-carrying capacity of steel

Table B. 56 Angle bracket type 6503S13, Variant TCP, Fastener GH Screw 5x40, Density 350 kg/m³Characteristic load-carrying capacity $F_{1,Rk}$ (N) for one / two angle brackets

angle bracket		1													2
f (mm)		0	10	20	30	40	50	60	70	80	90	100	110	120	0
$F_{1,Rk}$	T	8012	8012	4253	2835	2126	1701	1418	1215	1063	945	851	773	709	16024
	S	25	22	20	18	17	15	14	13	12	12	11	10	10	50
k_t (-)		12,5	14,1	15,6	17,2	18,7	20,2	21,8	23,3	24,8	26,4	27,9	29,5	31,0	6,3

Characteristic load-carrying capacity $F_{2/3,Rk}$ (N) for one / two angle brackets

angle bracket		1	2
$F_{2/3,Rk}$	T	1670	3340
	S	-	-

Characteristic load-carrying capacity $F_{4,Rk}$ (N) for one angle bracket

e (mm)		0	20	40	60	80	100	120	140	160	180	200	220	240	260	280	300	320
$F_{4,Rk}$	T	-	-	-	24300	3619	1955	1339	1019	822	689	593	520	463	418	381	349	323
	S	-	104	52	34	26	20	17	14	13	11	10	9	8	8	7	6	6
k_t (-)		0,0	3,1	6,2	9,2	12,3	15,4	18,5	21,5	24,6	27,7	30,8	33,8	36,9	40,0	43,1	46,2	49,2

Characteristic load-carrying capacity $F_{5,Rk}$ (N) for one angle bracket

b / e (mm)		0	20	40	60	80	100	120	140	160	180	200	220	240	260	280	300	320
0	T	1505	2330	5155	2142	1607	1285	1071	918	803	714	643	584	536	494	459	428	402
	S	281	435	600	400	300	240	200	171	150	133	120	109	100	92	85	80	75
20	T	1505	2330	5155	2142	1607	1285	1071	918	803	714	643	584	536	494	459	428	402
	S	281	435	600	400	300	240	200	171	150	133	120	109	100	92	85	80	75
40	T	1505	2330	5155	2142	1607	1285	1071	918	803	714	643	584	536	494	459	428	402
	S	281	435	600	400	300	240	200	171	150	133	120	109	100	92	85	80	75
60	T	1505	2330	5155	2142	1607	1285	1071	918	803	714	643	584	536	494	459	428	402
	S	281	435	600	400	300	240	200	171	150	133	120	109	100	92	85	80	75
80	T	1505	2330	5155	2142	1607	1285	1071	918	803	714	643	584	536	494	459	428	402
	S	281	435	600	400	300	240	200	171	150	133	120	109	100	92	85	80	75
100	T	1505	2330	5155	2142	1607	1285	1071	918	803	714	643	584	536	494	459	428	402
	S	281	435	600	400	300	240	200	171	150	133	120	109	100	92	85	80	75
120	T	1505	2330	5155	2142	1607	1285	1071	918	803	714	643	584	536	494	459	428	402
	S	281	435	600	400	300	240	200	171	150	133	120	109	100	92	85	80	75
140	T	1505	2330	5155	2142	1607	1285	1071	918	803	714	643	584	536	494	459	428	402
	S	281	435	600	400	300	240	200	171	150	133	120	109	100	92	85	80	75
160	T	1505	2330	5155	2142	1607	1285	1071	918	803	714	643	584	536	494	459	428	402
	S	281	435	600	400	300	240	200	171	150	133	120	109	100	92	85	80	75
180	T	1505	2330	5155	2142	1607	1285	1071	918	803	714	643	584	536	494	459	428	402
	S	281	435	600	400	300	240	200	171	150	133	120	109	100	92	85	80	75
200	T	1505	2330	5155	2142	1607	1285	1071	918	803	714	643	584	536	494	459	428	402
	S	281	435	600	400	300	240	200	171	150	133	120	109	100	92	85	80	75
220	T	1505	2330	5155	2142	1607	1285	1071	918	803	714	643	584	536	494	459	428	402
	S	281	435	600	400	300	240	200	171	150	133	120	109	100	92	85	80	75
240	T	1505	2330	5155	2142	1607	1285	1071	918	803	714	643	584	536	494	459	428	402
	S	281	435	600	400	300	240	200	171	150	133	120	109	100	92	85	80	75
$k_t \times b$ (-)		0,0	15,2	30,5	45,7	61,0	76,2	91,4	106,7	121,9	137,1	152,4	167,6	182,9	198,1	213,3	228,6	243,8

Characteristic load-carrying capacity $F_{4/5,Rk}$ (N) for two angle brackets

b / e (mm)		0	20	40	60	80	100	120	140	160	180	200	220	240	260	280	300	320
0	T	15120	15120	15120	15120	15120	15120	15120	15120	15120	15120	15120	15120	15120	15120	15120	15120	15120
	S	-	-	-	-	-	-	-	-	-	-	-	-	-	-	-	-	-
20	T	15120	8012	4006	2671	2003	1602	1335	1145	1002	890	801	728	668	616	572	534	501
	S	-	25	12	8	6	5	4	3	3	2	2	2	2	1	1	1	1
40	T	15120	15120	8012	5341	4006	3205	2671	2289	2003	1780	1602	1457	1335	1233	1145	1068	1002
	S	-	51	25	17	12	10	8	7	6	5	5	4	4	3	3	3	3
60	T	15120	15120	12018	8012	6009	4807	4006	3434	3005	2671	2404	2185	2003	1849	1717	1602	1502
	S	-	76	38	25	19	15	12	10	9	8	7	6	6	5	5	5	4
80	T	15120	15120	15120	10683	8012	6410	5341	4578	4006	3561	3205	2913	2671	2465	2289	2137	2003
	S	-	102	51	34	25	20	17	14	12	11	10	9	8	7	7	6	6
100	T	15120	15120	15120	13353	10015	8012	6677	5723	5008	4451	4006	3642	3338	3082	2861	2671	2504
	S	-	127	63	42	31	25	21	18	15	14	12	11	10	9	9	8	7
120	T	15120	15120	15120	15120	12018	9614	8012	6867	6009	5341	4807	4370	4006	3698	3434	3205	3005
	S	-	153	76	51	38	30	25	21	19	17	15	13	12	11	10	10	9
140	T	15120	15120	15120	15120	14021	11217	9347	8012	7011	6232	5608	5099	4674	4314	4006	3739	3505
	S	-	178	89	59	44	35	29	25	22	19	17	16	14	13	12	11	11
160	T	15120	15120	15120	15120	15120	12819	10683	9157	8012	7122	6410	5827	5341	4930	4578	4273	4006
	S	-	204	102	68	51	40	34	29	25	22	20	18	17	15	14	13	12
180	T	15120	15120	15120	15120	15120	14422	12018	10301	9014	8012	7211	6555	6009	5547	5151	4807	4507
	S	-	229	114	76	57	45	38	32	28	25	22	20	19	17	16	15	14
200	T	15120	15120	15120	15120	15120	15120	13353	11446	10015	8902	8012	7284	6677	6163	5723	5341	5008
	S	-	255	127	85	63	51	42	36	31	28	25	23	21	19	18	17	15
220	T	15120	15120	15120	15120	15120	15120	14689	12590	11017	9792	8813	8012	7344	6779	6295	5875	5508
	S	-	280	140	93	70	56	46	40	35	31	28	25	23	21	20	18	17
240	T	15120	15120	15120	15120	15120	15120	15120	13735	12018	10683	9614	8740	8012	7396	6867	6410	6009
	S	-	306	153	102	76	61	51	43	38	34	30	27	25	23	21	20	19
$k_t \times b$ (-)		0,0	250,8	501,5	752,3	1003,1	1253,8	1504,6	1755,4	2006,2	2256,9	2507,7	2758,5	3009,2	3260,0	3510,8	3761,5	4012,3

TTM: Timber-Timber-Maximum | TTP: Timber-Timber-Partial | TCM: Timber-Concrete-Maximum | TCP: Timber-Concrete-Partial

T: $F_{1,T,Rk}$ load-carrying capacity of timber | S: $F_{1,S,Rk}$ load-carrying capacity of steel

Table B. 57 Angle bracket type 6503S13, Variant TCP, Fastener GH Screw 5x60, Density 350 kg/m³

Characteristic load-carrying capacity $F_{1,Rk}$ (N) for one / two angle brackets																		
angle bracket	1													2				
f (mm)	0	10	20	30	40	50	60	70	80	90	100	110	120	0				
$F_{1,Rk}$	T	9060	9060	6615	4410	3308	2646	2205	1890	1654	1470	1323	1203	1103	18120			
	S	25	22	20	18	17	15	14	13	12	12	11	10	10	50			
k_t (-)	12,5 14,1 15,6 17,2 18,7 20,2 21,8 23,3 24,8 26,4 27,9 29,5 31,0 6,3																	
Characteristic load-carrying capacity $F_{2/3,Rk}$ (N) for one / two angle brackets																		
angle bracket	1		2															
$F_{2/3,Rk}$	T	2270		4540														
	S	-		-														
Characteristic load-carrying capacity $F_{4,Rk}$ (N) for one angle bracket																		
e (mm)	0	20	40	60	80	100	120	140	160	180	200	220	240	260	280	300	320	
$F_{4,Rk}$	T	-	-	-	37800	5630	3041	2083	1584	1278	1071	922	809	721	650	592	543	502
	S	-	104	52	34	26	20	17	14	13	11	10	9	8	8	7	6	6
k_t (-)	0,0 3,1 6,2 9,2 12,3 15,4 18,5 21,5 24,6 27,7 30,8 33,8 36,9 40,0 43,1 46,2 49,2																	
Characteristic load-carrying capacity $F_{5,Rk}$ (N) for one angle bracket																		
b / e (mm)	0	20	40	60	80	100	120	140	160	180	200	220	240	260	280	300	320	
0	T	2342	3625	8018	3332	2499	1999	1666	1428	1250	1111	1000	909	833	769	714	666	625
	S	281	435	600	400	300	240	200	171	150	133	120	109	100	92	85	80	75
20	T	2342	3625	8018	3020	2265	1812	1510	1294	1133	1007	906	824	755	697	647	604	566
	S	281	435	600	400	300	240	200	171	150	133	120	109	100	92	85	80	75
40	T	2342	3625	8018	3332	2499	1999	1666	1428	1250	1111	1000	909	833	769	714	666	625
	S	281	435	600	400	300	240	200	171	150	133	120	109	100	92	85	80	75
60	T	2342	3625	8018	3332	2499	1999	1666	1428	1250	1111	1000	909	833	769	714	666	625
	S	281	435	600	400	300	240	200	171	150	133	120	109	100	92	85	80	75
80	T	2342	3625	8018	3332	2499	1999	1666	1428	1250	1111	1000	909	833	769	714	666	625
	S	281	435	600	400	300	240	200	171	150	133	120	109	100	92	85	80	75
100	T	2342	3625	8018	3332	2499	1999	1666	1428	1250	1111	1000	909	833	769	714	666	625
	S	281	435	600	400	300	240	200	171	150	133	120	109	100	92	85	80	75
120	T	2342	3625	8018	3332	2499	1999	1666	1428	1250	1111	1000	909	833	769	714	666	625
	S	281	435	600	400	300	240	200	171	150	133	120	109	100	92	85	80	75
140	T	2342	3625	8018	3332	2499	1999	1666	1428	1250	1111	1000	909	833	769	714	666	625
	S	281	435	600	400	300	240	200	171	150	133	120	109	100	92	85	80	75
160	T	2342	3625	8018	3332	2499	1999	1666	1428	1250	1111	1000	909	833	769	714	666	625
	S	281	435	600	400	300	240	200	171	150	133	120	109	100	92	85	80	75
180	T	2342	3625	8018	3332	2499	1999	1666	1428	1250	1111	1000	909	833	769	714	666	625
	S	281	435	600	400	300	240	200	171	150	133	120	109	100	92	85	80	75
200	T	2342	3625	8018	3332	2499	1999	1666	1428	1250	1111	1000	909	833	769	714	666	625
	S	281	435	600	400	300	240	200	171	150	133	120	109	100	92	85	80	75
220	T	2342	3625	8018	3332	2499	1999	1666	1428	1250	1111	1000	909	833	769	714	666	625
	S	281	435	600	400	300	240	200	171	150	133	120	109	100	92	85	80	75
240	T	2342	3625	8018	3332	2499	1999	1666	1428	1250	1111	1000	909	833	769	714	666	625
	S	281	435	600	400	300	240	200	171	150	133	120	109	100	92	85	80	75
$k_x \times b$ (-)	0,0 15,2 30,5 45,7 61,0 76,2 91,4 106,7 121,9 137,1 152,4 167,6 182,9 198,1 213,3 228,6 243,8																	
Characteristic load-carrying capacity $F_{4/5,Rk}$ (N) for two angle brackets																		
b / e (mm)	0	20	40	60	80	100	120	140	160	180	200	220	240	260	280	300	320	
0	T	23519	23519	23519	23519	23519	23519	23519	23519	23519	23519	23519	23519	23519	23519	23519	23519	
	S	-	-	-	-	-	-	-	-	-	-	-	-	-	-	-	-	
20	T	23519	9060	4530	3020	2265	1812	1510	1294	1133	1007	906	824	755	697	647	604	566
	S	-	25	12	8	6	5	4	3	3	2	2	2	2	1	1	1	1
40	T	23519	18120	9060	6040	4530	3624	3020	2589	2265	2013	1812	1647	1510	1394	1294	1208	1133
	S	-	51	25	17	12	10	8	7	6	5	5	4	4	3	3	3	3
60	T	23519	23520	13590	9060	6795	5436	4530	3883	3398	3020	2718	2471	2265	2091	1941	1812	1699
	S	-	76	38	25	19	15	12	10	9	8	7	6	6	5	5	5	4
80	T	23519	23520	18120	12080	9060	7248	6040	5177	4530	4027	3624	3295	3020	2788	2589	2416	2265
	S	-	102	51	34	25	20	17	14	12	11	10	9	8	7	7	6	6
100	T	23519	23520	22650	15100	11325	9060	7550	6471	5663	5033	4530	4118	3775	3485	3236	3020	2831
	S	-	127	63	42	31	25	21	18	15	14	12	11	10	9	9	8	7
120	T	23519	23520	23520	18120	13590	10872	9060	7766	6795	6040	5436	4942	4530	4182	3883	3624	3398
	S	-	153	76	51	38	30	25	21	19	17	15	13	12	11	10	10	9
140	T	23519	23520	23520	21140	15855	12684	10570	9060	7928	7047	6342	5765	5285	4878	4530	4228	3964
	S	-	178	89	59	44	35	29	25	22	19	17	16	14	13	12	11	11
160	T	23519	23520	23520	23520	18120	14496	12080	10354	9060	8053	7248	6589	6040	5575	5177	4832	4530
	S	-	204	102	68	51	40	34	29	25	22	20	18	17	15	14	13	12
180	T	23519	23520	23520	23520	20385	16308	13590	11649	10193	9060	8154	7413	6795	6272	5824	5436	5096
	S	-	229	114	76	57	45	38	32	28	25	22	20	19	17	16	15	14
200	T	23519	23520	23520	23520	22650	18120	15100	12943	11325	10067	9060	8236	7550	6969	6471	6040	5663
	S	-	255	127	85	63	51	42	36	31	28	25	23	21	19	18	17	15
220	T	23519	23520	23520	23520	23520	19932	16610	14237	12458	11073	9966	9060	8305	7666	7119	6644	6229
	S	-	280	140	93	70	56	46	40	35	31	28	25	23	21	20	18	17
240	T	23519	23520	23520	23520	23520	21744	18120	15531	13590	12080	10872	9884	9060	8363	7766	7248	6795
	S	-	306	153	102	76	61	51	43	38	34	30	27	25	23	21	20	19
$k_x \times b$ (-)	0,0 250,8 501,5 752,3 1003,1 1253,8 1504,6 1755,4 2006,2 2256,9 2507,7 2758,5 3009,2 3260,0 3510,8 3761,5 4012,3																	

TTM: Timber-Timber-Maximum | TTP: Timber-Timber-Partial | TCM: Timber-Concrete-Maximum | TCP: Timber-Concrete-Partial

T: $F_{1,T,Rk}$ load-carrying capacity of timber | S: $F_{1,S,Rk}$ load-carrying capacity of steel

Table B. 58 Angle bracket type 6503S13, Variant TTM, Fastener GH Nail 4x40, Density 350 kg/m³Characteristic load-carrying capacity $F_{T,Rk}$ (N) for one / two angle brackets

angle bracket		1													2
f (mm)		0	10	20	30	40	50	60	70	80	90	100	110	120	0
$F_{T,Rk}$	T	1945	1652	1436	1270	1139	977	814	698	611	543	489	444	407	3889
	S	377	320	278	246	220	186	155	133	116	103	93	84	77	754

Characteristic load-carrying capacity $F_{2/3,Rk}$ (N) for one / two angle brackets

angle bracket		1	2
$F_{2/3,Rk}$	T	5460	10920
	S	-	-

Characteristic load-carrying capacity $F_{4,Rk}$ (N) for one angle bracket

e (mm)		0	20	40	60	80	100	120	140	160	180	200	220	240	260	280	300	320
$F_{4,Rk}$	T	18899	5494	2747	1831	1373	1099	769	585	472	396	340	299	266	240	219	201	185
	S	-	1065	532	355	266	213	147	111	90	75	65	57	50	45	41	38	35

Characteristic load-carrying capacity $F_{5,Rk}$ (N) for one angle bracket

b / e (mm)		0	20	40	60	80	100	120	140	160	180	200	220	240	260	280	300	320
0	T	865	1339	2961	2194	1645	1316	1097	940	823	731	658	598	548	506	470	439	411
	S	165	256	566	400	300	240	200	171	150	133	120	109	100	92	85	80	75
20	T	865	1339	2961	2194	1645	1316	1097	940	823	731	658	598	548	506	470	439	411
	S	165	256	566	400	300	240	200	171	150	133	120	109	100	92	85	80	75
40	T	865	1339	2961	2194	1645	1316	1097	940	823	731	658	598	548	506	470	439	411
	S	165	256	566	400	300	240	200	171	150	133	120	109	100	92	85	80	75
60	T	865	1339	2961	2194	1645	1316	1097	940	823	731	658	598	548	506	470	439	411
	S	165	256	566	400	300	240	200	171	150	133	120	109	100	92	85	80	75
80	T	865	1339	2961	2194	1645	1316	1097	940	823	731	658	598	548	506	470	439	411
	S	165	256	566	400	300	240	200	171	150	133	120	109	100	92	85	80	75
100	T	865	1339	2961	2194	1645	1316	1097	940	823	731	658	598	548	506	470	439	411
	S	165	256	566	400	300	240	200	171	150	133	120	109	100	92	85	80	75
120	T	865	1339	2961	2194	1645	1316	1097	940	823	731	658	598	548	506	470	439	411
	S	165	256	566	400	300	240	200	171	150	133	120	109	100	92	85	80	75
140	T	865	1339	2961	2194	1645	1316	1097	940	823	731	658	598	548	506	470	439	411
	S	165	256	566	400	300	240	200	171	150	133	120	109	100	92	85	80	75
160	T	865	1339	2961	2194	1645	1316	1097	940	823	731	658	598	548	506	470	439	411
	S	165	256	566	400	300	240	200	171	150	133	120	109	100	92	85	80	75
180	T	865	1339	2961	2194	1645	1316	1097	940	823	731	658	598	548	506	470	439	411
	S	165	256	566	400	300	240	200	171	150	133	120	109	100	92	85	80	75
200	T	865	1339	2961	2194	1645	1316	1097	940	823	731	658	598	548	506	470	439	411
	S	165	256	566	400	300	240	200	171	150	133	120	109	100	92	85	80	75
220	T	865	1339	2961	2194	1645	1316	1097	940	823	731	658	598	548	506	470	439	411
	S	165	256	566	400	300	240	200	171	150	133	120	109	100	92	85	80	75
240	T	865	1339	2961	2194	1645	1316	1097	940	823	731	658	598	548	506	470	439	411
	S	165	256	566	400	300	240	200	171	150	133	120	109	100	92	85	80	75

Characteristic load-carrying capacity $F_{4/5,Rk}$ (N) for two angle brackets

b / e (mm)		0	20	40	60	80	100	120	140	160	180	200	220	240	260	280	300	320
0	T	14400	14400	14400	14400	14400	14400	14400	14400	14400	14400	14400	14400	14400	14400	14400	14400	14400
	S	-	-	-	-	-	-	-	-	-	-	-	-	-	-	-	-	-
20	T	14400	1945	972	648	486	389	324	278	243	216	194	177	162	150	139	130	122
	S	-	377	188	125	94	75	62	53	47	41	37	34	31	29	26	25	23
40	T	14400	3889	1945	1296	972	778	648	556	486	432	389	354	324	299	278	259	243
	S	-	754	377	251	188	150	125	107	94	83	75	68	62	58	53	50	47
60	T	14400	5834	2917	1945	1458	1167	972	833	729	648	583	530	486	449	417	389	365
	S	-	1131	565	377	282	226	188	161	141	125	113	102	94	87	80	75	70
80	T	14400	7779	3889	2593	1945	1556	1296	1111	972	864	778	707	648	598	556	519	486
	S	-	1508	754	502	377	301	251	215	188	167	150	137	125	116	107	100	94
100	T	14400	9723	4862	3241	2431	1945	1621	1389	1215	1080	972	884	810	748	695	648	608
	S	-	1886	943	628	471	377	314	269	235	209	188	171	157	145	134	125	117
120	T	14400	11668	5834	3889	2917	2334	1945	1667	1458	1296	1167	1061	972	898	833	778	729
	S	-	2263	1131	754	565	452	377	323	282	251	226	205	188	174	161	150	141
140	T	14400	13613	6806	4538	3403	2723	2269	1945	1702	1513	1361	1238	1134	1047	972	908	851
	S	-	2640	1320	880	660	528	440	377	330	293	264	240	220	203	188	176	165
160	T	14400	14400	7779	5186	3889	3111	2593	2222	1945	1729	1556	1414	1296	1197	1111	1037	972
	S	-	3017	1508	1005	754	603	502	431	377	335	301	274	251	232	215	201	188
180	T	14400	14400	8751	5834	4375	3500	2917	2500	2188	1945	1750	1591	1458	1346	1250	1167	1094
	S	-	3395	1697	1131	848	679	565	485	424	377	339	308	282	261	242	226	212
200	T	14400	14400	9723	6482	4862	3889	3241	2778	2431	2161	1945	1768	1621	1496	1389	1296	1215
	S	-	3772	1886	1257	943	754	628	538	471	419	377	342	314	290	269	251	235
220	T	14400	14400	10696	7130	5348	4278	3565	3056	2674	2377	2139	1945	1783	1645	1528	1426	1337
	S	-	4149	2074	1383	1037	829	691	592	518	461	414	377	345	319	296	276	259
240	T	14400	14400	11668	7779	5834	4667	3889	3334	2917	2593	2334	2121	1945	1795	1667	1556	1458
	S	-	4526	2263	1508	1131	905	754	646	565	502	452	411	377	348	323	301	282

TTM: Timber-Timber-Maximum | TTP: Timber-Timber-Partial | TCM: Timber-Concrete-Maximum | TCP: Timber-Concrete-Partial

T: $F_{T,Rk}$ load-carrying capacity of timber | S: $F_{S,Rk}$ load-carrying capacity of steel

Table B. 59 Angle bracket type 6503S13, Variant TTM, Fastener GH Nail 4x60, Density 350 kg/m³Characteristic load-carrying capacity $F_{1,Rk}$ (N) for one / two angle brackets

angle bracket		1													2
f (mm)		0	10	20	30	40	50	60	70	80	90	100	110	120	0
$F_{1,Rk}$	T	3241	2754	2394	2117	1898	1629	1357	1163	1018	905	814	740	679	6482
	S	377	320	278	246	220	186	155	133	116	103	93	84	77	754

Characteristic load-carrying capacity $F_{2/3,Rk}$ (N) for one / two angle brackets

angle bracket		1	2
$F_{2/3,Rk}$	T	7090	14180
	S	-	-

Characteristic load-carrying capacity $F_{4,Rk}$ (N) for one angle bracket

e (mm)		0	20	40	60	80	100	120	140	160	180	200	220	240	260	280	300	320
$F_{4,Rk}$	T	23639	9156	4578	3052	2289	1831	1282	975	787	659	567	498	444	400	364	334	309
	S	-	1065	532	355	266	213	147	111	90	75	65	57	50	45	41	38	35

Characteristic load-carrying capacity $F_{5,Rk}$ (N) for one angle bracket

b / e (mm)		0	20	40	60	80	100	120	140	160	180	200	220	240	260	280	300	320
0	T	1441	2231	4935	3656	2742	2194	1828	1567	1371	1219	1097	997	914	844	783	731	686
	S	165	256	566	400	300	240	200	171	150	133	120	109	100	92	85	80	75
20	T	1441	2231	4935	3656	2742	2194	1828	1567	1371	1219	1097	997	914	844	783	731	686
	S	165	256	566	400	300	240	200	171	150	133	120	109	100	92	85	80	75
40	T	1441	2231	4935	3656	2742	2194	1828	1567	1371	1219	1097	997	914	844	783	731	686
	S	165	256	566	400	300	240	200	171	150	133	120	109	100	92	85	80	75
60	T	1441	2231	4935	3656	2742	2194	1828	1567	1371	1219	1097	997	914	844	783	731	686
	S	165	256	566	400	300	240	200	171	150	133	120	109	100	92	85	80	75
80	T	1441	2231	4935	3656	2742	2194	1828	1567	1371	1219	1097	997	914	844	783	731	686
	S	165	256	566	400	300	240	200	171	150	133	120	109	100	92	85	80	75
100	T	1441	2231	4935	3656	2742	2194	1828	1567	1371	1219	1097	997	914	844	783	731	686
	S	165	256	566	400	300	240	200	171	150	133	120	109	100	92	85	80	75
120	T	1441	2231	4935	3656	2742	2194	1828	1567	1371	1219	1097	997	914	844	783	731	686
	S	165	256	566	400	300	240	200	171	150	133	120	109	100	92	85	80	75
140	T	1441	2231	4935	3656	2742	2194	1828	1567	1371	1219	1097	997	914	844	783	731	686
	S	165	256	566	400	300	240	200	171	150	133	120	109	100	92	85	80	75
160	T	1441	2231	4935	3656	2742	2194	1828	1567	1371	1219	1097	997	914	844	783	731	686
	S	165	256	566	400	300	240	200	171	150	133	120	109	100	92	85	80	75
180	T	1441	2231	4935	3656	2742	2194	1828	1567	1371	1219	1097	997	914	844	783	731	686
	S	165	256	566	400	300	240	200	171	150	133	120	109	100	92	85	80	75
200	T	1441	2231	4935	3656	2742	2194	1828	1567	1371	1219	1097	997	914	844	783	731	686
	S	165	256	566	400	300	240	200	171	150	133	120	109	100	92	85	80	75
220	T	1441	2231	4935	3656	2742	2194	1828	1567	1371	1219	1097	997	914	844	783	731	686
	S	165	256	566	400	300	240	200	171	150	133	120	109	100	92	85	80	75
240	T	1441	2231	4935	3656	2742	2194	1828	1567	1371	1219	1097	997	914	844	783	731	686
	S	165	256	566	400	300	240	200	171	150	133	120	109	100	92	85	80	75

Characteristic load-carrying capacity $F_{4/5,Rk}$ (N) for two angle brackets

b / e (mm)		0	20	40	60	80	100	120	140	160	180	200	220	240	260	280	300	320
0	T	23999	23999	23999	23999	23999	23999	23999	23999	23999	23999	23999	23999	23999	23999	23999	23999	23999
	S	-	-	-	-	-	-	-	-	-	-	-	-	-	-	-	-	-
20	T	23999	3241	1621	1080	810	648	540	463	405	360	324	295	270	249	232	216	203
	S	-	377	188	125	94	75	62	53	47	41	37	34	31	29	26	25	23
40	T	23999	6482	3241	2161	1621	1296	1080	926	810	720	648	589	540	499	463	432	405
	S	-	754	377	251	188	150	125	107	94	83	75	68	62	58	53	50	47
60	T	23999	9723	4862	3241	2431	1945	1621	1389	1215	1080	972	884	810	748	695	648	608
	S	-	1131	565	377	282	226	188	161	141	125	113	102	94	87	80	75	70
80	T	23999	12964	6482	4321	3241	2593	2161	1852	1621	1440	1296	1179	1080	997	926	864	810
	S	-	1508	754	502	377	301	251	215	188	167	150	137	125	116	107	100	94
100	T	23999	16205	8103	5402	4051	3241	2701	2315	2026	1801	1621	1473	1350	1247	1158	1080	1013
	S	-	1886	943	628	471	377	314	269	235	209	188	171	157	145	134	125	117
120	T	23999	19447	9723	6482	4862	3889	3241	2778	2431	2161	1945	1768	1621	1496	1389	1296	1215
	S	-	2263	1131	754	565	452	377	323	282	251	226	205	188	174	161	150	141
140	T	23999	22688	11344	7563	5672	4538	3781	3241	2836	2521	2269	2063	1891	1745	1621	1513	1418
	S	-	2640	1320	880	660	528	440	377	330	293	264	240	220	203	188	176	165
160	T	23999	24000	12964	8643	6482	5186	4321	3704	3241	2881	2593	2357	2161	1995	1852	1729	1621
	S	-	3017	1508	1005	754	603	502	431	377	335	301	274	251	232	215	201	188
180	T	23999	24000	14585	9723	7292	5834	4862	4167	3646	3241	2917	2652	2431	2244	2084	1945	1823
	S	-	3395	1697	1131	848	679	565	485	424	377	339	308	282	261	242	226	212
200	T	23999	24000	16205	10804	8103	6482	5402	4630	4051	3601	3241	2946	2701	2493	2315	2161	2026
	S	-	3772	1886	1257	943	754	628	538	471	419	377	342	314	290	269	251	235
220	T	23999	24000	17826	11884	8913	7130	5942	5093	4456	3961	3565	3241	2971	2742	2547	2377	2228
	S	-	4149	2074	1383	1037	829	691	592	518	461	414	377	345	319	296	276	259
240	T	23999	24000	19447	12964	9723	7779	6482	5556	4862	4321	3889	3536	3241	2992	2778	2593	2431
	S	-	4526	2263	1508	1131	905	754	646	565	502	452	411	377	348	323	301	282

TTM: Timber-Timber-Maximum | TTP: Timber-Timber-Partial | TCM: Timber-Concrete-Maximum | TCP: Timber-Concrete-Partial

T: $F_{1,T,Rk}$ load-carrying capacity of timber | S: $F_{1,S,Rk}$ load-carrying capacity of steel

Table B. 60 Angle bracket type 6503S13, Variant TTM, Fastener GH Screw 5x40, Density 350 kg/m³Characteristic load-carrying capacity $F_{1,Rk}$ (N) for one / two angle brackets

angle bracket		1													2
f (mm)		0	10	20	30	40	50	60	70	80	90	100	110	120	0
$F_{1,Rk}$	T	4084	3470	3016	2667	2391	2052	1710	1466	1283	1140	1026	933	855	8168
	S	377	320	278	246	220	186	155	133	116	103	93	84	77	754

Characteristic load-carrying capacity $F_{2/3,Rk}$ (N) for one / two angle brackets

angle bracket		1	2
$F_{2/3,Rk}$	T	6270	12540
	S	-	-

Characteristic load-carrying capacity $F_{4,Rk}$ (N) for one angle bracket

e (mm)		0	20	40	60	80	100	120	140	160	180	200	240	260	280	300	320	
$F_{4,Rk}$	T	20029	11537	5768	3846	2884	2307	1616	1229	991	831	715	628	559	504	459	421	389
	S	-	1065	532	355	266	213	147	111	90	75	65	57	50	45	41	38	35

Characteristic load-carrying capacity $F_{5,Rk}$ (N) for one angle bracket

b / e (mm)		0	20	40	60	80	100	120	140	160	180	200	220	240	260	280	300	320
0	T	1816	2811	6218	4607	3455	2764	2303	1974	1727	1536	1382	1256	1152	1063	987	921	864
	S	165	256	566	400	300	240	200	171	150	133	120	109	100	92	85	80	75
20	T	1816	2811	6218	4607	3455	2764	2303	1974	1727	1536	1382	1256	1152	1063	987	921	864
	S	165	256	566	400	300	240	200	171	150	133	120	109	100	92	85	80	75
40	T	1816	2811	6218	4607	3455	2764	2303	1974	1727	1536	1382	1256	1152	1063	987	921	864
	S	165	256	566	400	300	240	200	171	150	133	120	109	100	92	85	80	75
60	T	1816	2811	6218	4607	3455	2764	2303	1974	1727	1536	1382	1256	1152	1063	987	921	864
	S	165	256	566	400	300	240	200	171	150	133	120	109	100	92	85	80	75
80	T	1816	2811	6218	4607	3455	2764	2303	1974	1727	1536	1382	1256	1152	1063	987	921	864
	S	165	256	566	400	300	240	200	171	150	133	120	109	100	92	85	80	75
100	T	1816	2811	6218	4607	3455	2764	2303	1974	1727	1536	1382	1256	1152	1063	987	921	864
	S	165	256	566	400	300	240	200	171	150	133	120	109	100	92	85	80	75
120	T	1816	2811	6218	4607	3455	2764	2303	1974	1727	1536	1382	1256	1152	1063	987	921	864
	S	165	256	566	400	300	240	200	171	150	133	120	109	100	92	85	80	75
140	T	1816	2811	6218	4607	3455	2764	2303	1974	1727	1536	1382	1256	1152	1063	987	921	864
	S	165	256	566	400	300	240	200	171	150	133	120	109	100	92	85	80	75
160	T	1816	2811	6218	4607	3455	2764	2303	1974	1727	1536	1382	1256	1152	1063	987	921	864
	S	165	256	566	400	300	240	200	171	150	133	120	109	100	92	85	80	75
180	T	1816	2811	6218	4607	3455	2764	2303	1974	1727	1536	1382	1256	1152	1063	987	921	864
	S	165	256	566	400	300	240	200	171	150	133	120	109	100	92	85	80	75
200	T	1816	2811	6218	4607	3455	2764	2303	1974	1727	1536	1382	1256	1152	1063	987	921	864
	S	165	256	566	400	300	240	200	171	150	133	120	109	100	92	85	80	75
220	T	1816	2811	6218	4607	3455	2764	2303	1974	1727	1536	1382	1256	1152	1063	987	921	864
	S	165	256	566	400	300	240	200	171	150	133	120	109	100	92	85	80	75
240	T	1816	2811	6218	4607	3455	2764	2303	1974	1727	1536	1382	1256	1152	1063	987	921	864
	S	165	256	566	400	300	240	200	171	150	133	120	109	100	92	85	80	75

Characteristic load-carrying capacity $F_{4/5,Rk}$ (N) for two angle brackets

b / e (mm)		0	20	40	60	80	100	120	140	160	180	200	220	240	260	280	300	320
0	T	30239	30239	30239	30239	30239	30239	30239	30239	30239	30239	30239	30239	30239	30239	30239	30239	30239
	S	-	-	-	-	-	-	-	-	-	-	-	-	-	-	-	-	-
20	T	30239	4084	2042	1361	1021	817	681	583	510	454	408	371	340	314	292	272	255
	S	-	377	188	125	94	75	62	53	47	41	37	34	31	29	26	25	23
40	T	30239	8168	4084	2723	2042	1634	1361	1167	1021	908	817	743	681	628	583	545	510
	S	-	754	377	251	188	150	125	107	94	83	75	68	62	58	53	50	47
60	T	30239	12251	6126	4084	3063	2450	2042	1750	1531	1361	1225	1114	1021	942	875	817	766
	S	-	1131	565	377	282	226	188	161	141	125	113	102	94	87	80	75	70
80	T	30239	16335	8168	5445	4084	3267	2723	2334	2042	1815	1634	1485	1361	1257	1167	1089	1021
	S	-	1508	754	502	377	301	251	215	188	167	150	137	125	116	107	100	94
100	T	30239	20419	10209	6806	5105	4084	3403	2917	2552	2269	2042	1856	1702	1571	1458	1361	1276
	S	-	1886	943	628	471	377	314	269	235	209	188	171	157	145	134	125	117
120	T	30239	24503	12251	8168	6126	4901	4084	3500	3063	2723	2450	2228	2042	1885	1750	1634	1531
	S	-	2263	1131	754	565	452	377	323	282	251	226	205	188	174	161	150	141
140	T	30239	28586	14293	9529	7147	5717	4764	4084	3573	3176	2859	2599	2382	2199	2042	1906	1787
	S	-	2640	1320	880	660	528	440	377	330	293	264	240	220	203	188	176	165
160	T	30239	30240	16335	10890	8168	6534	5445	4667	4084	3630	3267	2970	2723	2513	2334	2178	2042
	S	-	3017	1508	1005	754	603	502	431	377	335	301	274	251	232	215	201	188
180	T	30239	30240	18377	12251	9188	7351	6126	5251	4594	4084	3675	3341	3063	2827	2625	2450	2297
	S	-	3395	1697	1131	848	679	565	485	424	377	339	308	282	261	242	226	212
200	T	30239	30240	20419	13613	10209	8168	6806	5834	5105	4538	4084	3713	3403	3141	2917	2723	2552
	S	-	3772	1886	1257	943	754	628	538	471	419	377	342	314	290	269	251	235
220	T	30239	30240	22461	14974	11230	8984	7487	6417	5615	4991	4492	4084	3743	3456	3209	2995	2808
	S	-	4149	2074	1383	1037	829	691	592	518	461	414	377	345	319	296	276	259
240	T	30239	30240	24503	16335	12251	9801	8168	7001	6126	5445	4901	4455	4084	3770	3500	3267	3063
	S	-	4526	2263	1508	1131	905	754	646	565	502	452	411	377	348	323	301	282

TTM: Timber-Timber-Maximum | TTP: Timber-Timber-Partial | TCM: Timber-Concrete-Maximum | TCP: Timber-Concrete-Partial

T: $F_{1,T,Rk}$ load-carrying capacity of timber | S: $F_{1,S,Rk}$ load-carrying capacity of steel

Table B. 61 Angle bracket type 6503S13, Variant TTM, Fastener GH Screw 5x60, Density 350 kg/m³Characteristic load-carrying capacity $F_{T,Rk}$ (N) for one / two angle brackets

angle bracket		1													2
f (mm)		0	10	20	30	40	50	60	70	80	90	100	110	120	0
$F_{T,Rk}$	T	6353	5397	4692	4149	3719	3192	2660	2280	1995	1773	1596	1451	1330	12705
	S	377	320	278	246	220	186	155	133	116	103	93	84	77	754

Characteristic load-carrying capacity $F_{2/3,Rk}$ (N) for one / two angle brackets

angle bracket		1	2
$F_{2/3,Rk}$	T	7280	14560
	S	-	-

Characteristic load-carrying capacity $F_{4,Rk}$ (N) for one angle bracket

e (mm)		0	20	40	60	80	100	120	140	160	180	200	220	240	260	280	300	320
$F_{4,Rk}$	T	22649	17946	8973	5982	4486	3589	2513	1911	1542	1292	1112	976	870	784	714	655	606
	S	-	1065	532	355	266	213	147	111	90	75	65	57	50	45	41	38	35

Characteristic load-carrying capacity $F_{5,Rk}$ (N) for one angle bracket

b / e (mm)		0	20	40	60	80	100	120	140	160	180	200	220	240	260	280	300	320
0	T	2825	4373	9673	7166	5374	4299	3583	3071	2687	2389	2150	1954	1791	1654	1536	1433	1344
	S	165	256	566	400	300	240	200	171	150	133	120	109	100	92	85	80	75
20	T	2825	4373	9673	6040	4530	3624	3020	2589	2265	2013	1812	1647	1510	1394	1294	1208	1133
	S	165	256	566	400	300	240	200	171	150	133	120	109	100	92	85	80	75
40	T	2825	4373	9673	7166	5374	4299	3583	3071	2687	2389	2150	1954	1791	1654	1536	1433	1344
	S	165	256	566	400	300	240	200	171	150	133	120	109	100	92	85	80	75
60	T	2825	4373	9673	7166	5374	4299	3583	3071	2687	2389	2150	1954	1791	1654	1536	1433	1344
	S	165	256	566	400	300	240	200	171	150	133	120	109	100	92	85	80	75
80	T	2825	4373	9673	7166	5374	4299	3583	3071	2687	2389	2150	1954	1791	1654	1536	1433	1344
	S	165	256	566	400	300	240	200	171	150	133	120	109	100	92	85	80	75
100	T	2825	4373	9673	7166	5374	4299	3583	3071	2687	2389	2150	1954	1791	1654	1536	1433	1344
	S	165	256	566	400	300	240	200	171	150	133	120	109	100	92	85	80	75
120	T	2825	4373	9673	7166	5374	4299	3583	3071	2687	2389	2150	1954	1791	1654	1536	1433	1344
	S	165	256	566	400	300	240	200	171	150	133	120	109	100	92	85	80	75
140	T	2825	4373	9673	7166	5374	4299	3583	3071	2687	2389	2150	1954	1791	1654	1536	1433	1344
	S	165	256	566	400	300	240	200	171	150	133	120	109	100	92	85	80	75
160	T	2825	4373	9673	7166	5374	4299	3583	3071	2687	2389	2150	1954	1791	1654	1536	1433	1344
	S	165	256	566	400	300	240	200	171	150	133	120	109	100	92	85	80	75
180	T	2825	4373	9673	7166	5374	4299	3583	3071	2687	2389	2150	1954	1791	1654	1536	1433	1344
	S	165	256	566	400	300	240	200	171	150	133	120	109	100	92	85	80	75
200	T	2825	4373	9673	7166	5374	4299	3583	3071	2687	2389	2150	1954	1791	1654	1536	1433	1344
	S	165	256	566	400	300	240	200	171	150	133	120	109	100	92	85	80	75
220	T	2825	4373	9673	7166	5374	4299	3583	3071	2687	2389	2150	1954	1791	1654	1536	1433	1344
	S	165	256	566	400	300	240	200	171	150	133	120	109	100	92	85	80	75
240	T	2825	4373	9673	7166	5374	4299	3583	3071	2687	2389	2150	1954	1791	1654	1536	1433	1344
	S	165	256	566	400	300	240	200	171	150	133	120	109	100	92	85	80	75

Characteristic load-carrying capacity $F_{4/5,Rk}$ (N) for two angle brackets

b / e (mm)		0	20	40	60	80	100	120	140	160	180	200	220	240	260	280	300	320
0	T	45300	45300	45300	45300	45300	45300	45300	45300	45300	45300	45300	45300	45300	45300	45300	45300	45300
	S	-	-	-	-	-	-	-	-	-	-	-	-	-	-	-	-	-
20	T	45300	6353	3176	2118	1588	1271	1059	908	794	706	635	578	529	489	454	424	397
	S	-	377	188	125	94	75	62	53	47	41	37	34	31	29	26	25	23
40	T	45300	12705	6353	4235	3176	2541	2118	1815	1588	1412	1271	1155	1059	977	908	847	794
	S	-	754	377	251	188	150	125	107	94	83	75	68	62	58	53	50	47
60	T	45300	19058	9529	6353	4764	3812	3176	2723	2382	2118	1906	1733	1588	1466	1361	1271	1191
	S	-	1131	565	377	282	226	188	161	141	125	113	102	94	87	80	75	70
80	T	45300	25410	12705	8470	6353	5082	4235	3630	3176	2823	2541	2310	2118	1955	1815	1694	1588
	S	-	1508	754	502	377	301	251	215	188	167	150	137	125	116	107	100	94
100	T	45300	31763	15881	10588	7941	6353	5294	4538	3970	3529	3176	2888	2647	2443	2269	2118	1985
	S	-	1886	943	628	471	377	314	269	235	209	188	171	157	145	134	125	117
120	T	45300	38115	19058	12705	9529	7623	6353	5445	4764	4235	3812	3465	3176	2932	2723	2541	2382
	S	-	2263	1131	754	565	452	377	323	282	251	226	205	188	174	161	150	141
140	T	45300	44468	22234	14823	11117	8894	7411	6353	5558	4941	4447	4043	3706	3421	3176	2965	2779
	S	-	2640	1320	880	660	528	440	377	330	293	264	240	220	203	188	176	165
160	T	45300	45300	25410	16940	12705	10164	8470	7260	6353	5647	5082	4620	4235	3909	3630	3388	3176
	S	-	3017	1508	1005	754	603	502	431	377	335	301	274	251	232	215	201	188
180	T	45300	45300	28586	19058	14293	11435	9529	8168	7147	6353	5717	5198	4764	4398	4084	3812	3573
	S	-	3395	1697	1131	848	679	565	485	424	377	339	308	282	261	242	226	212
200	T	45300	45300	31763	21175	15881	12705	10588	9075	7941	7058	6353	5775	5294	4887	4538	4235	3970
	S	-	3772	1886	1257	943	754	628	538	471	419	377	342	314	290	269	251	235
220	T	45300	45300	34939	23293	17469	13976	11646	9983	8735	7764	6988	6353	5823	5375	4991	4659	4367
	S	-	4149	2074	1383	1037	829	691	592	518	461	414	377	345	319	296	276	259
240	T	45300	45300	38115	25410	19058	15246	12705	10890	9529	8470	7623	6930	6353	5864	5445	5082	4764
	S	-	4526	2263	1508	1131	905	754	646	565	502	452	411	377	348	323	301	282

TTM: Timber-Timber-Maximum | TTP: Timber-Timber-Partial | TCM: Timber-Concrete-Maximum | TCP: Timber-Concrete-Partial

T: $F_{T,Rk}$ load-carrying capacity of timber | S: $F_{S,Rk}$ load-carrying capacity of steel

Table B. 62 Angle bracket type 6503S13, Variant TTP, Fastener GH Nail 4x40, Density 350 kg/m³Characteristic load-carrying capacity $F_{T,Rk}$ (N) for one / two angle brackets

angle bracket		1													2
f (mm)		0	10	20	30	40	50	60	70	80	90	100	110	120	0
$F_{T,Rk}$	T	1833	1557	1354	1197	1013	810	675	579	506	450	405	368	338	3665
	S	585	497	432	382	342	310	264	226	198	176	158	144	132	1170

Characteristic load-carrying capacity $F_{2/3,Rk}$ (N) for one / two angle brackets

angle bracket		1	2
$F_{2/3,Rk}$	T	3530	7060
	S	-	-

Characteristic load-carrying capacity $F_{4,Rk}$ (N) for one angle bracket

e (mm)		0	20	40	60	80	100	120	140	160	180	200	220	240	260	280	300	320
$F_{4,Rk}$	T	11340	5177	2589	1726	1294	931	638	485	391	328	282	248	221	199	181	166	154
	S	-	1200	600	400	300	240	200	171	150	128	110	97	86	78	71	65	60

Characteristic load-carrying capacity $F_{5,Rk}$ (N) for one angle bracket

b / e (mm)		0	20	40	60	80	100	120	140	160	180	200	220	240	260	280	300	320
0	T	717	1110	1869	1020	765	612	510	437	383	340	306	278	255	235	219	204	191
	S	281	435	600	400	300	240	200	171	150	133	120	109	100	92	85	80	75
20	T	717	1110	2455	1020	765	612	510	437	383	340	306	278	255	235	219	204	191
	S	281	435	600	400	300	240	200	171	150	133	120	109	100	92	85	80	75
40	T	717	1110	2455	1020	765	612	510	437	383	340	306	278	255	235	219	204	191
	S	281	435	600	400	300	240	200	171	150	133	120	109	100	92	85	80	75
60	T	717	1110	2455	1020	765	612	510	437	383	340	306	278	255	235	219	204	191
	S	281	435	600	400	300	240	200	171	150	133	120	109	100	92	85	80	75
80	T	717	1110	2455	1020	765	612	510	437	383	340	306	278	255	235	219	204	191
	S	281	435	600	400	300	240	200	171	150	133	120	109	100	92	85	80	75
100	T	717	1110	2455	1020	765	612	510	437	383	340	306	278	255	235	219	204	191
	S	281	435	600	400	300	240	200	171	150	133	120	109	100	92	85	80	75
120	T	717	1110	2455	1020	765	612	510	437	383	340	306	278	255	235	219	204	191
	S	281	435	600	400	300	240	200	171	150	133	120	109	100	92	85	80	75
140	T	717	1110	2455	1020	765	612	510	437	383	340	306	278	255	235	219	204	191
	S	281	435	600	400	300	240	200	171	150	133	120	109	100	92	85	80	75
160	T	717	1110	2455	1020	765	612	510	437	383	340	306	278	255	235	219	204	191
	S	281	435	600	400	300	240	200	171	150	133	120	109	100	92	85	80	75
180	T	717	1110	2455	1020	765	612	510	437	383	340	306	278	255	235	219	204	191
	S	281	435	600	400	300	240	200	171	150	133	120	109	100	92	85	80	75
200	T	717	1110	2455	1020	765	612	510	437	383	340	306	278	255	235	219	204	191
	S	281	435	600	400	300	240	200	171	150	133	120	109	100	92	85	80	75
220	T	717	1110	2455	1020	765	612	510	437	383	340	306	278	255	235	219	204	191
	S	281	435	600	400	300	240	200	171	150	133	120	109	100	92	85	80	75
240	T	717	1110	2455	1020	765	612	510	437	383	340	306	278	255	235	219	204	191
	S	281	435	600	400	300	240	200	171	150	133	120	109	100	92	85	80	75

Characteristic load-carrying capacity $F_{4/5,Rk}$ (N) for two angle brackets

b / e (mm)		0	20	40	60	80	100	120	140	160	180	200	220	240	260	280	300	320
0	T	7199	7199	7199	7199	7199	7199	7199	7199	7199	7199	7199	7199	7199	7199	7199	7199	7199
	S	-	-	-	-	-	-	-	-	-	-	-	-	-	-	-	-	-
20	T	7199	1833	916	611	458	367	305	262	229	204	183	167	153	141	131	122	115
	S	-	585	292	195	146	117	97	83	73	65	58	53	48	45	41	39	36
40	T	7199	3665	1833	1222	916	733	611	524	458	407	367	333	305	282	262	244	229
	S	-	1171	585	390	292	234	195	167	146	130	117	106	97	90	83	78	73
60	T	7199	5498	2749	1833	1375	1100	916	785	687	611	550	500	458	423	393	367	344
	S	-	1757	878	585	439	351	292	251	219	195	175	159	146	135	125	117	109
80	T	7199	7200	3665	2444	1833	1466	1222	1047	916	815	733	666	611	564	524	489	458
	S	-	2343	1171	781	585	468	390	334	292	260	234	213	195	180	167	156	146
100	T	7199	7200	4582	3055	2291	1833	1527	1309	1145	1018	916	833	764	705	655	611	573
	S	-	2928	1464	976	732	585	488	418	366	325	292	266	244	225	209	195	183
120	T	7199	7200	5498	3665	2749	2199	1833	1571	1375	1222	1100	1000	916	846	785	733	687
	S	-	3514	1757	1171	878	702	585	502	439	390	351	319	292	270	251	234	219
140	T	7199	7200	6415	4276	3207	2566	2138	1833	1604	1425	1283	1166	1069	987	916	855	802
	S	-	4100	2050	1366	1025	820	683	585	512	455	410	372	341	315	292	273	256
160	T	7199	7200	7200	4887	3665	2932	2444	2095	1833	1629	1466	1333	1222	1128	1047	977	916
	S	-	4686	2343	1562	1171	937	781	669	585	520	468	426	390	360	334	312	292
180	T	7199	7200	7200	5498	4124	3299	2749	2356	2062	1833	1649	1499	1375	1269	1178	1100	1031
	S	-	5271	2635	1757	1317	1054	878	753	658	585	527	479	439	405	376	351	329
200	T	7199	7200	7200	6109	4582	3665	3055	2618	2291	2036	1833	1666	1527	1410	1309	1222	1145
	S	-	5857	2928	1952	1464	1171	976	836	732	650	585	532	488	450	418	390	366
220	T	7199	7200	7200	6720	5040	4032	3360	2880	2520	2240	2016	1833	1680	1551	1440	1344	1260
	S	-	6443	3221	2147	1610	1288	1073	920	805	715	644	585	536	495	460	429	402
240	T	7199	7200	7200	7200	5498	4399	3665	3142	2749	2444	2199	1999	1833	1692	1571	1466	1375
	S	-	7029	3514	2343	1757	1405	1171	1004	878	781	702	639	585	540	502	468	439

TTM: Timber-Timber-Maximum | TTP: Timber-Timber-Partial | TCM: Timber-Concrete-Maximum | TCP: Timber-Concrete-Partial

T: $F_{T,Rk}$ load-carrying capacity of timber | S: $F_{S,Rk}$ load-carrying capacity of steel

Table B. 63 Angle bracket type 6503S13, Variant TTP, Fastener GH Nail 4x60, Density 350 kg/m³Characteristic load-carrying capacity $F_{T,Rk}$ (N) for one / two angle brackets

angle bracket		1													2
f (mm)		0	10	20	30	40	50	60	70	80	90	100	110	120	0
$F_{T,Rk}$	T	3055	2595	2256	1995	1688	1350	1125	964	844	750	675	614	563	6109
	S	585	497	432	382	342	310	264	226	198	176	158	144	132	1170

Characteristic load-carrying capacity $F_{2/3,Rk}$ (N) for one / two angle brackets

angle bracket		1	2
$F_{2/3,Rk}$	T	4650	9300
	S	-	-

Characteristic load-carrying capacity $F_{4,Rk}$ (N) for one angle bracket

e (mm)		0	20	40	60	80	100	120	140	160	180	200	220	240	260	280	300	320
$F_{4,Rk}$	T	14184	8629	4315	2876	2157	1552	1063	808	652	547	470	413	368	332	302	277	256
	S	-	1200	600	400	300	240	200	171	150	128	110	97	86	78	71	65	60

Characteristic load-carrying capacity $F_{5,Rk}$ (N) for one angle bracket

b / e (mm)		0	20	40	60	80	100	120	140	160	180	200	220	240	260	280	300	320
0	T	1195	1849	3115	1700	1275	1020	850	729	638	567	510	464	425	392	364	340	319
	S	281	435	600	400	300	240	200	171	150	133	120	109	100	92	85	80	75
20	T	1195	1849	4091	1700	1275	1020	850	729	638	567	510	464	425	392	364	340	319
	S	281	435	600	400	300	240	200	171	150	133	120	109	100	92	85	80	75
40	T	1195	1849	4091	1700	1275	1020	850	729	638	567	510	464	425	392	364	340	319
	S	281	435	600	400	300	240	200	171	150	133	120	109	100	92	85	80	75
60	T	1195	1849	4091	1700	1275	1020	850	729	638	567	510	464	425	392	364	340	319
	S	281	435	600	400	300	240	200	171	150	133	120	109	100	92	85	80	75
80	T	1195	1849	4091	1700	1275	1020	850	729	638	567	510	464	425	392	364	340	319
	S	281	435	600	400	300	240	200	171	150	133	120	109	100	92	85	80	75
100	T	1195	1849	4091	1700	1275	1020	850	729	638	567	510	464	425	392	364	340	319
	S	281	435	600	400	300	240	200	171	150	133	120	109	100	92	85	80	75
120	T	1195	1849	4091	1700	1275	1020	850	729	638	567	510	464	425	392	364	340	319
	S	281	435	600	400	300	240	200	171	150	133	120	109	100	92	85	80	75
140	T	1195	1849	4091	1700	1275	1020	850	729	638	567	510	464	425	392	364	340	319
	S	281	435	600	400	300	240	200	171	150	133	120	109	100	92	85	80	75
160	T	1195	1849	4091	1700	1275	1020	850	729	638	567	510	464	425	392	364	340	319
	S	281	435	600	400	300	240	200	171	150	133	120	109	100	92	85	80	75
180	T	1195	1849	4091	1700	1275	1020	850	729	638	567	510	464	425	392	364	340	319
	S	281	435	600	400	300	240	200	171	150	133	120	109	100	92	85	80	75
200	T	1195	1849	4091	1700	1275	1020	850	729	638	567	510	464	425	392	364	340	319
	S	281	435	600	400	300	240	200	171	150	133	120	109	100	92	85	80	75
220	T	1195	1849	4091	1700	1275	1020	850	729	638	567	510	464	425	392	364	340	319
	S	281	435	600	400	300	240	200	171	150	133	120	109	100	92	85	80	75
240	T	1195	1849	4091	1700	1275	1020	850	729	638	567	510	464	425	392	364	340	319
	S	281	435	600	400	300	240	200	171	150	133	120	109	100	92	85	80	75

Characteristic load-carrying capacity $F_{4/5,Rk}$ (N) for two angle brackets

b / e (mm)		0	20	40	60	80	100	120	140	160	180	200	220	240	260	280	300	320
0	T	12000	12000	12000	12000	12000	12000	12000	12000	12000	12000	12000	12000	12000	12000	12000	12000	12000
	S	-	-	-	-	-	-	-	-	-	-	-	-	-	-	-	-	-
20	T	12000	3055	1527	1018	764	611	509	436	382	339	305	278	255	235	218	204	191
	S	-	585	292	195	146	117	97	83	73	65	58	53	48	45	41	39	36
40	T	12000	6109	3055	2036	1527	1222	1018	873	764	679	611	555	509	470	436	407	382
	S	-	1171	585	390	292	234	195	167	146	130	117	106	97	90	83	78	73
60	T	12000	9164	4582	3055	2291	1833	1527	1309	1145	1018	916	833	764	705	655	611	573
	S	-	1757	878	585	439	351	292	251	219	195	175	159	146	135	125	117	109
80	T	12000	12000	6109	4073	3055	2444	2036	1745	1527	1358	1222	1111	1018	940	873	815	764
	S	-	2343	1171	781	585	468	390	334	292	260	234	213	195	180	167	156	146
100	T	12000	12000	7636	5091	3818	3055	2545	2182	1909	1697	1527	1388	1273	1175	1091	1018	955
	S	-	2928	1464	976	732	585	488	418	366	325	292	266	244	225	209	195	183
120	T	12000	12000	9164	6109	4582	3665	3055	2618	2291	2036	1833	1666	1527	1410	1309	1222	1145
	S	-	3514	1757	1171	878	702	585	502	439	390	351	319	292	270	251	234	219
140	T	12000	12000	10691	7127	5345	4276	3564	3055	2673	2376	2138	1944	1782	1645	1527	1425	1336
	S	-	4100	2050	1366	1025	820	683	585	512	455	410	372	341	315	292	273	256
160	T	12000	12000	12000	8145	6109	4887	4073	3491	3055	2715	2444	2221	2036	1880	1745	1629	1527
	S	-	4686	2343	1562	1171	937	781	669	585	520	468	426	390	360	334	312	292
180	T	12000	12000	12000	9164	6873	5498	4582	3927	3436	3055	2749	2499	2291	2115	1964	1833	1718
	S	-	5271	2635	1757	1317	1054	878	753	658	585	527	479	439	405	376	351	329
200	T	12000	12000	12000	10182	7636	6109	5091	4364	3818	3394	3055	2777	2545	2350	2182	2036	1909
	S	-	5857	2928	1952	1464	1171	976	836	732	650	585	532	488	450	418	390	366
220	T	12000	12000	12000	11200	8400	6720	5600	4800	4200	3733	3360	3055	2800	2585	2400	2240	2100
	S	-	6443	3221	2147	1610	1288	1073	920	805	715	644	585	536	495	460	429	402
240	T	12000	12000	12000	12000	9164	7331	6109	5236	4582	4073	3665	3332	3055	2820	2618	2444	2291
	S	-	7029	3514	2343	1757	1405	1171	1004	878	781	702	639	585	540	502	468	439

TTM: Timber-Timber-Maximum | TTP: Timber-Timber-Partial | TCM: Timber-Concrete-Maximum | TCP: Timber-Concrete-Partial

T: $F_{T,Rk}$ load-carrying capacity of timber | S: $F_{S,Rk}$ load-carrying capacity of steel

Table B. 64 Angle bracket type 6503S13, Variant TTP, Fastener GH Screw 5x40, Density 350 kg/m³Characteristic load-carrying capacity $F_{T,Rk}$ (N) for one / two angle brackets

angle bracket		1													2
f (mm)		0	10	20	30	40	50	60	70	80	90	100	110	120	0
$F_{T,Rk}$	T	3849	3270	2843	2514	2126	1701	1418	1215	1063	945	851	773	709	7697
	S	585	497	432	382	342	310	264	226	198	176	158	144	132	1170

Characteristic load-carrying capacity $F_{2/3,Rk}$ (N) for one / two angle brackets

angle bracket		1	2
$F_{2/3,Rk}$	T	4220	8440
	S	-	-

Characteristic load-carrying capacity $F_{4,Rk}$ (N) for one angle bracket

e (mm)		0	20	40	60	80	100	120	140	160	180	200	220	240	260	280	300	320
$F_{4,Rk}$	T	12018	10873	5436	3624	2718	1955	1339	1019	822	689	593	520	463	418	381	349	323
	S	-	1200	600	400	300	240	200	171	150	128	110	97	86	78	71	65	60

Characteristic load-carrying capacity $F_{5,Rk}$ (N) for one angle bracket

b / e (mm)		0	20	40	60	80	100	120	140	160	180	200	220	240	260	280	300	320
0	T	1505	2330	3925	2142	1607	1285	1071	918	803	714	643	584	536	494	459	428	402
	S	281	435	600	400	300	240	200	171	150	133	120	109	100	92	85	80	75
20	T	1505	2330	5155	2142	1607	1285	1071	918	803	714	643	584	536	494	459	428	402
	S	281	435	600	400	300	240	200	171	150	133	120	109	100	92	85	80	75
40	T	1505	2330	5155	2142	1607	1285	1071	918	803	714	643	584	536	494	459	428	402
	S	281	435	600	400	300	240	200	171	150	133	120	109	100	92	85	80	75
60	T	1505	2330	5155	2142	1607	1285	1071	918	803	714	643	584	536	494	459	428	402
	S	281	435	600	400	300	240	200	171	150	133	120	109	100	92	85	80	75
80	T	1505	2330	5155	2142	1607	1285	1071	918	803	714	643	584	536	494	459	428	402
	S	281	435	600	400	300	240	200	171	150	133	120	109	100	92	85	80	75
100	T	1505	2330	5155	2142	1607	1285	1071	918	803	714	643	584	536	494	459	428	402
	S	281	435	600	400	300	240	200	171	150	133	120	109	100	92	85	80	75
120	T	1505	2330	5155	2142	1607	1285	1071	918	803	714	643	584	536	494	459	428	402
	S	281	435	600	400	300	240	200	171	150	133	120	109	100	92	85	80	75
140	T	1505	2330	5155	2142	1607	1285	1071	918	803	714	643	584	536	494	459	428	402
	S	281	435	600	400	300	240	200	171	150	133	120	109	100	92	85	80	75
160	T	1505	2330	5155	2142	1607	1285	1071	918	803	714	643	584	536	494	459	428	402
	S	281	435	600	400	300	240	200	171	150	133	120	109	100	92	85	80	75
180	T	1505	2330	5155	2142	1607	1285	1071	918	803	714	643	584	536	494	459	428	402
	S	281	435	600	400	300	240	200	171	150	133	120	109	100	92	85	80	75
200	T	1505	2330	5155	2142	1607	1285	1071	918	803	714	643	584	536	494	459	428	402
	S	281	435	600	400	300	240	200	171	150	133	120	109	100	92	85	80	75
220	T	1505	2330	5155	2142	1607	1285	1071	918	803	714	643	584	536	494	459	428	402
	S	281	435	600	400	300	240	200	171	150	133	120	109	100	92	85	80	75
240	T	1505	2330	5155	2142	1607	1285	1071	918	803	714	643	584	536	494	459	428	402
	S	281	435	600	400	300	240	200	171	150	133	120	109	100	92	85	80	75

Characteristic load-carrying capacity $F_{4/5,Rk}$ (N) for two angle brackets

b / e (mm)		0	20	40	60	80	100	120	140	160	180	200	220	240	260	280	300	320
0	T	15120	15120	15120	15120	15120	15120	15120	15120	15120	15120	15120	15120	15120	15120	15120	15120	15120
	S	-	-	-	-	-	-	-	-	-	-	-	-	-	-	-	-	-
20	T	15120	3849	1924	1283	962	770	641	550	481	428	385	350	321	296	275	257	241
	S	-	585	292	195	146	117	97	83	73	65	58	53	48	45	41	39	36
40	T	15120	7697	3849	2566	1924	1539	1283	1100	962	855	770	700	641	592	550	513	481
	S	-	1171	585	390	292	234	195	167	146	130	117	106	97	90	83	78	73
60	T	15120	11546	5773	3849	2887	2309	1924	1649	1443	1283	1155	1050	962	888	825	770	722
	S	-	1757	878	585	439	351	292	251	219	195	175	159	146	135	125	117	109
80	T	15120	15120	7697	5132	3849	3079	2566	2199	1924	1711	1539	1400	1283	1184	1100	1026	962
	S	-	2343	1171	781	585	468	390	334	292	260	234	213	195	180	167	156	146
100	T	15120	15120	9622	6415	4811	3849	3207	2749	2405	2138	1924	1749	1604	1480	1375	1283	1203
	S	-	2928	1464	976	732	585	488	418	366	325	292	266	244	225	209	195	183
120	T	15120	15120	11546	7697	5773	4618	3849	3299	2887	2566	2309	2099	1924	1776	1649	1539	1443
	S	-	3514	1757	1171	878	702	585	502	439	390	351	319	292	270	251	234	219
140	T	15120	15120	13470	8980	6735	5388	4490	3849	3368	2993	2694	2449	2245	2072	1924	1796	1684
	S	-	4100	2050	1366	1025	820	683	585	512	455	410	372	341	315	292	273	256
160	T	15120	15120	15120	10263	7697	6158	5132	4399	3849	3421	3079	2799	2566	2368	2199	2053	1924
	S	-	4686	2343	1562	1171	937	781	669	585	520	468	426	390	360	334	312	292
180	T	15120	15120	15120	11546	8660	6928	5773	4948	4330	3849	3464	3149	2887	2664	2474	2309	2165
	S	-	5271	2635	1757	1317	1054	878	753	658	585	527	479	439	405	376	351	329
200	T	15120	15120	15120	12829	9622	7697	6415	5498	4811	4276	3849	3499	3207	2961	2749	2566	2405
	S	-	5857	2928	1952	1464	1171	976	836	732	650	585	532	488	450	418	390	366
220	T	15120	15120	15120	14112	10584	8467	7056	6048	5292	4704	4234	3849	3528	3257	3024	2822	2646
	S	-	6443	3221	2147	1610	1288	1073	920	805	715	644	585	536	495	460	429	402
240	T	15120	15120	15120	15120	11546	9237	7697	6598	5773	5132	4618	4199	3849	3553	3299	3079	2887
	S	-	7029	3514	2343	1757	1405	1171	1004	878	781	702	639	585	540	502	468	439

TTM: Timber-Timber-Maximum | TTP: Timber-Timber-Partial | TCM: Timber-Concrete-Maximum | TCP: Timber-Concrete-Partial

T: $F_{T,Rk}$ load-carrying capacity of timber | S: $F_{S,Rk}$ load-carrying capacity of steel

Table B. 65 Angle bracket type 6503S13, Variant TTP, Fastener GH Screw 5x60, Density 350 kg/m³Characteristic load-carrying capacity $F_{1,Rk}$ (N) for one / two angle brackets

angle bracket		1													2
f (mm)		0	10	20	30	40	50	60	70	80	90	100	110	120	0
$F_{1,Rk}$	T	5987	5087	4422	3911	3308	2646	2205	1890	1654	1470	1323	1203	1103	11974
	S	585	497	432	382	342	310	264	226	198	176	158	144	132	1170

Characteristic load-carrying capacity $F_{2/3,Rk}$ (N) for one / two angle brackets

angle bracket		1	2
$F_{2/3,Rk}$	T	4990	9980
	S	-	-

Characteristic load-carrying capacity $F_{4,Rk}$ (N) for one angle bracket

e (mm)		0	20	40	60	80	100	120	140	160	180	200	220	240	260	280	300	320
$F_{4,Rk}$	T	13590	13590	8456	5638	4228	3041	2083	1584	1278	1071	922	809	721	650	592	543	502
	S	-	1200	600	400	300	240	200	171	150	128	110	97	86	78	71	65	60

Characteristic load-carrying capacity $F_{5,Rk}$ (N) for one angle bracket

b / e (mm)		0	20	40	60	80	100	120	140	160	180	200	220	240	260	280	300	320
0	T	2342	3625	6105	3332	2499	1999	1666	1428	1250	1111	1000	909	833	769	714	666	625
	S	281	435	600	400	300	240	200	171	150	133	120	109	100	92	85	80	75
20	T	2342	3625	8018	3020	2265	1812	1510	1294	1133	1007	906	824	755	697	647	604	566
	S	281	435	600	400	300	240	200	171	150	133	120	109	100	92	85	80	75
40	T	2342	3625	8018	3332	2499	1999	1666	1428	1250	1111	1000	909	833	769	714	666	625
	S	281	435	600	400	300	240	200	171	150	133	120	109	100	92	85	80	75
60	T	2342	3625	8018	3332	2499	1999	1666	1428	1250	1111	1000	909	833	769	714	666	625
	S	281	435	600	400	300	240	200	171	150	133	120	109	100	92	85	80	75
80	T	2342	3625	8018	3332	2499	1999	1666	1428	1250	1111	1000	909	833	769	714	666	625
	S	281	435	600	400	300	240	200	171	150	133	120	109	100	92	85	80	75
100	T	2342	3625	8018	3332	2499	1999	1666	1428	1250	1111	1000	909	833	769	714	666	625
	S	281	435	600	400	300	240	200	171	150	133	120	109	100	92	85	80	75
120	T	2342	3625	8018	3332	2499	1999	1666	1428	1250	1111	1000	909	833	769	714	666	625
	S	281	435	600	400	300	240	200	171	150	133	120	109	100	92	85	80	75
140	T	2342	3625	8018	3332	2499	1999	1666	1428	1250	1111	1000	909	833	769	714	666	625
	S	281	435	600	400	300	240	200	171	150	133	120	109	100	92	85	80	75
160	T	2342	3625	8018	3332	2499	1999	1666	1428	1250	1111	1000	909	833	769	714	666	625
	S	281	435	600	400	300	240	200	171	150	133	120	109	100	92	85	80	75
180	T	2342	3625	8018	3332	2499	1999	1666	1428	1250	1111	1000	909	833	769	714	666	625
	S	281	435	600	400	300	240	200	171	150	133	120	109	100	92	85	80	75
200	T	2342	3625	8018	3332	2499	1999	1666	1428	1250	1111	1000	909	833	769	714	666	625
	S	281	435	600	400	300	240	200	171	150	133	120	109	100	92	85	80	75
220	T	2342	3625	8018	3332	2499	1999	1666	1428	1250	1111	1000	909	833	769	714	666	625
	S	281	435	600	400	300	240	200	171	150	133	120	109	100	92	85	80	75
240	T	2342	3625	8018	3332	2499	1999	1666	1428	1250	1111	1000	909	833	769	714	666	625
	S	281	435	600	400	300	240	200	171	150	133	120	109	100	92	85	80	75

Characteristic load-carrying capacity $F_{4/5,Rk}$ (N) for two angle brackets

b / e (mm)		0	20	40	60	80	100	120	140	160	180	200	220	240	260	280	300	320
0	T	23519	23519	23519	23519	23519	23519	23519	23519	23519	23519	23519	23519	23519	23519	23519	23519	23519
	S	-	-	-	-	-	-	-	-	-	-	-	-	-	-	-	-	-
20	T	23519	5987	2993	1996	1497	1197	998	855	748	665	599	544	499	461	428	399	374
	S	-	585	292	195	146	117	97	83	73	65	58	53	48	45	41	39	36
40	T	23519	11974	5987	3991	2993	2395	1996	1711	1497	1330	1197	1089	998	921	855	798	748
	S	-	1171	585	390	292	234	195	167	146	130	117	106	97	90	83	78	73
60	T	23519	17961	8980	5987	4490	3592	2993	2566	2245	1996	1796	1633	1497	1382	1283	1197	1123
	S	-	1757	878	585	439	351	292	251	219	195	175	159	146	135	125	117	109
80	T	23519	23520	11974	7983	5987	4790	3991	3421	2993	2661	2395	2177	1996	1842	1711	1597	1497
	S	-	2343	1171	781	585	468	390	334	292	260	234	213	195	180	167	156	146
100	T	23519	23520	14967	9978	7484	5987	4989	4276	3742	3326	2993	2721	2495	2303	2138	1996	1871
	S	-	2928	1464	976	732	585	488	418	366	325	292	266	244	225	209	195	183
120	T	23519	23520	17961	11974	8980	7184	5987	5132	4490	3991	3592	3266	2993	2763	2566	2395	2245
	S	-	3514	1757	1171	878	702	585	502	439	390	351	319	292	270	251	234	219
140	T	23519	23520	20954	13969	10477	8382	6985	5987	5239	4656	4191	3810	3492	3224	2993	2794	2619
	S	-	4100	2050	1366	1025	820	683	585	512	455	410	372	341	315	292	273	256
160	T	23519	23520	23520	15965	11974	9579	7983	6842	5987	5322	4790	4354	3991	3684	3421	3193	2993
	S	-	4686	2343	1562	1171	937	781	669	585	520	468	426	390	360	334	312	292
180	T	23519	23520	23520	17961	13470	10776	8980	7697	6735	5987	5388	4898	4490	4145	3849	3592	3368
	S	-	5271	2635	1757	1317	1054	878	753	658	585	527	479	439	405	376	351	329
200	T	23519	23520	23520	19956	14967	11974	9978	8553	7484	6652	5987	5443	4989	4605	4276	3991	3742
	S	-	5857	2928	1952	1464	1171	976	836	732	650	585	532	488	450	418	390	366
220	T	23519	23520	23520	21952	16464	13171	10976	9408	8232	7317	6586	5987	5488	5066	4704	4390	4116
	S	-	6443	3221	2147	1610	1288	1073	920	805	715	644	585	536	495	460	429	402
240	T	23519	23520	23520	23520	17961	14369	11974	10263	8980	7983	7184	6531	5987	5526	5132	4790	4490
	S	-	7029	3514	2343	1757	1405	1171	1004	878	781	702	639	585	540	502	468	439

TTM: Timber-Timber-Maximum | TTP: Timber-Timber-Partial | TCM: Timber-Concrete-Maximum | TCP: Timber-Concrete-Partial

T: $F_{1,T,Rk}$ load-carrying capacity of timber | S: $F_{1,S,Rk}$ load-carrying capacity of steel

Table B. 66 Angle bracket type 6504S, Variant TCM, Fastener GH Nail 4x40, Density 350 kg/m³Characteristic load-carrying capacity $F_{1,Rk}$ (N) for one / two angle brackets

angle bracket		1													2
f (mm)		0	10	20	30	40	50	60	70	80	90	100	110	120	0
$F_{1,Rk}$	T	15120	450	225	150	113	90	75	64	56	50	45	41	38	30240
	S	57	48	41	36	32	29	26	24	21	19	17	15	14	
k_t (-)		9,2	11,0	12,8	14,6	16,5	18,3	20,1	21,9	23,7	25,5	27,4	29,2	31,0	4,6

Characteristic load-carrying capacity $F_{2/3,Rk}$ (N) for one / two angle brackets

angle bracket		1	2
$F_{2/3,Rk}$	T	2570	5140
	S	-	-

Characteristic load-carrying capacity $F_{4,Rk}$ (N) for one angle bracket

e (mm)		0	20	40	60	80	100	120	140	160	180	200	220	240	260	280	300	320
$F_{4,Rk}$	T	-	-	1286	191	103	71	54	43	36	31	28	25	22	20	18	17	16
	S	-	145	72	48	36	27	21	16	14	12	10	9	8	7	7	6	6
k_t (-)		0,0	3,6	7,3	10,9	14,5	18,2	21,8	25,5	29,1	32,7	36,4	40,0	43,6	47,3	50,9	54,5	58,2

Characteristic load-carrying capacity $F_{5,Rk}$ (N) for one angle bracket

b / e (mm)		0	20	40	60	80	100	120	140	160	180	200	220	240	260	280	300	320
0	T	123	273	1530	1020	765	612	510	437	383	340	306	278	255	235	219	204	191
	S	48	106	596	397	298	238	198	170	149	132	119	108	99	91	85	79	74
20	T	123	273	1530	1020	765	612	510	437	383	340	306	278	255	235	219	204	191
	S	48	106	596	397	298	238	198	170	149	132	119	108	99	91	85	79	74
40	T	123	273	1530	1020	765	612	510	437	383	340	306	278	255	235	219	204	191
	S	48	106	596	397	298	238	198	170	149	132	119	108	99	91	85	79	74
60	T	123	273	1530	1020	765	612	510	437	383	340	306	278	255	235	219	204	191
	S	48	106	596	397	298	238	198	170	149	132	119	108	99	91	85	79	74
80	T	123	273	1530	1020	765	612	510	437	383	340	306	278	255	235	219	204	191
	S	48	106	596	397	298	238	198	170	149	132	119	108	99	91	85	79	74
100	T	123	273	1530	1020	765	612	510	437	383	340	306	278	255	235	219	204	191
	S	48	106	596	397	298	238	198	170	149	132	119	108	99	91	85	79	74
120	T	123	273	1530	1020	765	612	510	437	383	340	306	278	255	235	219	204	191
	S	48	106	596	397	298	238	198	170	149	132	119	108	99	91	85	79	74
140	T	123	273	1530	1020	765	612	510	437	383	340	306	278	255	235	219	204	191
	S	48	106	596	397	298	238	198	170	149	132	119	108	99	91	85	79	74
160	T	123	273	1530	1020	765	612	510	437	383	340	306	278	255	235	219	204	191
	S	48	106	596	397	298	238	198	170	149	132	119	108	99	91	85	79	74
180	T	123	273	1530	1020	765	612	510	437	383	340	306	278	255	235	219	204	191
	S	48	106	596	397	298	238	198	170	149	132	119	108	99	91	85	79	74
200	T	123	273	1530	1020	765	612	510	437	383	340	306	278	255	235	219	204	191
	S	48	106	596	397	298	238	198	170	149	132	119	108	99	91	85	79	74
220	T	123	273	1530	1020	765	612	510	437	383	340	306	278	255	235	219	204	191
	S	48	106	596	397	298	238	198	170	149	132	119	108	99	91	85	79	74
240	T	123	273	1530	1020	765	612	510	437	383	340	306	278	255	235	219	204	191
	S	48	106	596	397	298	238	198	170	149	132	119	108	99	91	85	79	74
$k_t \times b$ (-)		0,0	16,8	33,7	50,5	67,4	84,2	101,1	117,9	134,7	151,6	168,4	185,3	202,1	218,9	235,8	252,6	269,5

Characteristic load-carrying capacity $F_{4/5,Rk}$ (N) for two angle brackets

b / e (mm)		0	20	40	60	80	100	120	140	160	180	200	220	240	260	280	300	320
0	T	14400	14400	14400	14400	14400	14400	14400	14400	14400	14400	14400	14400	14400	14400	14400	14400	14400
	S	-	-	-	-	-	-	-	-	-	-	-	-	-	-	-	-	-
20	T	14400	14400	7560	5040	3780	3024	2520	2160	1890	1680	1512	1375	1260	1163	1080	1008	945
	S	-	57	28	19	14	11	9	8	7	6	5	5	4	4	4	3	3
40	T	14400	14400	14400	10080	7560	6048	5040	4320	3780	3360	3024	2749	2520	2326	2160	2016	1890
	S	-	115	57	38	28	23	19	16	14	12	11	10	9	8	8	7	7
60	T	14400	14400	14400	14400	11340	9072	7560	6480	5670	5040	4536	4124	3780	3489	3240	3024	2835
	S	-	173	86	57	43	34	28	24	21	19	17	15	14	13	12	11	10
80	T	14400	14400	14400	14400	14400	12096	10080	8640	7560	6720	6048	5498	5040	4652	4320	4032	3780
	S	-	231	115	77	57	46	38	33	28	25	23	21	19	17	16	15	14
100	T	14400	14400	14400	14400	14400	12600	10800	9450	8400	7560	6873	6300	5815	5400	5040	4725	4425
	S	-	288	144	96	72	57	48	41	36	32	28	26	24	22	20	19	18
120	T	14400	14400	14400	14400	14400	14400	14400	12960	11340	10080	9072	8247	7560	6978	6480	6048	5670
	S	-	346	173	115	86	69	57	49	43	38	34	31	28	26	24	23	21
140	T	14400	14400	14400	14400	14400	14400	14400	14400	13230	11760	10584	9622	8820	8142	7560	7056	6615
	S	-	404	202	134	101	80	67	57	50	44	40	36	33	31	28	26	25
160	T	14400	14400	14400	14400	14400	14400	14400	14400	14400	13440	12096	10996	10080	9305	8640	8064	7560
	S	-	462	231	154	115	92	77	66	57	51	46	42	38	35	33	30	28
180	T	14400	14400	14400	14400	14400	14400	14400	14400	14400	14400	13608	12371	11340	10468	9720	9072	8505
	S	-	519	259	173	129	103	86	74	64	57	51	47	43	39	37	34	32
200	T	14400	14400	14400	14400	14400	14400	14400	14400	14400	14400	14400	13745	12600	11631	10800	10080	9450
	S	-	577	288	192	144	115	96	82	72	64	57	52	48	44	41	38	36
220	T	14400	14400	14400	14400	14400	14400	14400	14400	14400	14400	14400	14400	13860	12794	11880	11088	10395
	S	-	635	317	211	158	127	105	90	79	70	63	57	52	48	45	42	39
240	T	14400	14400	14400	14400	14400	14400	14400	14400	14400	14400	14400	14400	14400	13957	12960	12096	11340
	S	-	693	346	231	173	138	115	99	86	77	69	63	57	53	49	46	43
$k_t \times b$ (-)		0,0	183,6	367,3	550,9	734,5	918,2	1101,8	1285,5	1469,1	1652,7	1836,4	2020,0	2203,6	2387,3	2570,9	2754,5	2938,2

TTM: Timber-Timber-Maximum | TTP: Timber-Timber-Partial | TCM: Timber-Concrete-Maximum | TCP: Timber-Concrete-Partial

T: $F_{1,T,Rk}$ load-carrying capacity of timber | S: $F_{1,S,Rk}$ load-carrying capacity of steel

Table B. 67 Angle bracket type 6504S, Variant TCM, Fastener GH Nail 4x60, Density 350 kg/m³

Characteristic load-carrying capacity $F_{1,Rk}$ (N) for one / two angle brackets															
angle bracket	1													2	
f (mm)	0	10	20	30	40	50	60	70	80	90	100	110	120	0	
$F_{1,Rk}$	T	18912	750	375	250	188	150	125	107	94	83	75	68	63	37824
	S	57	48	41	36	32	29	26	24	21	19	17	15	14	114
k_1 (-)	9,2	11,0	12,8	14,6	16,5	18,3	20,1	21,9	23,7	25,5	27,4	29,2	31,0	4,6	

Characteristic load-carrying capacity $F_{2/3,Rk}$ (N) for one / two angle brackets		
angle bracket	1	2
$F_{2/3,Rk}$	T	3780
	S	-

Characteristic load-carrying capacity $F_{4,Rk}$ (N) for one angle bracket																		
e (mm)	0	20	40	60	80	100	120	140	160	180	200	220	240	260	280	300	320	
$F_{4,Rk}$	T	-	-	2143	319	172	118	90	72	61	52	46	41	37	34	31	28	26
	S	-	145	72	48	36	27	21	16	14	12	10	9	8	7	7	6	6
k_1 (-)	0,0	3,6	7,3	10,9	14,5	18,2	21,8	25,5	29,1	32,7	36,4	40,0	43,6	47,3	50,9	54,5	58,2	

Characteristic load-carrying capacity $F_{5,Rk}$ (N) for one angle bracket																		
b / e (mm)	0	20	40	60	80	100	120	140	160	180	200	220	240	260	280	300	320	
0	T	205	455	2550	1700	1275	1020	850	729	638	567	510	464	425	392	364	340	319
	S	48	106	596	397	298	238	198	170	149	132	119	108	99	91	85	79	74
20	T	205	455	2550	1700	1275	1020	850	729	638	567	510	464	425	392	364	340	319
	S	48	106	596	397	298	238	198	170	149	132	119	108	99	91	85	79	74
40	T	205	455	2550	1700	1275	1020	850	729	638	567	510	464	425	392	364	340	319
	S	48	106	596	397	298	238	198	170	149	132	119	108	99	91	85	79	74
60	T	205	455	2550	1700	1275	1020	850	729	638	567	510	464	425	392	364	340	319
	S	48	106	596	397	298	238	198	170	149	132	119	108	99	91	85	79	74
80	T	205	455	2550	1700	1275	1020	850	729	638	567	510	464	425	392	364	340	319
	S	48	106	596	397	298	238	198	170	149	132	119	108	99	91	85	79	74
100	T	205	455	2550	1700	1275	1020	850	729	638	567	510	464	425	392	364	340	319
	S	48	106	596	397	298	238	198	170	149	132	119	108	99	91	85	79	74
120	T	205	455	2550	1700	1275	1020	850	729	638	567	510	464	425	392	364	340	319
	S	48	106	596	397	298	238	198	170	149	132	119	108	99	91	85	79	74
140	T	205	455	2550	1700	1275	1020	850	729	638	567	510	464	425	392	364	340	319
	S	48	106	596	397	298	238	198	170	149	132	119	108	99	91	85	79	74
160	T	205	455	2550	1700	1275	1020	850	729	638	567	510	464	425	392	364	340	319
	S	48	106	596	397	298	238	198	170	149	132	119	108	99	91	85	79	74
180	T	205	455	2550	1700	1275	1020	850	729	638	567	510	464	425	392	364	340	319
	S	48	106	596	397	298	238	198	170	149	132	119	108	99	91	85	79	74
200	T	205	455	2550	1700	1275	1020	850	729	638	567	510	464	425	392	364	340	319
	S	48	106	596	397	298	238	198	170	149	132	119	108	99	91	85	79	74
220	T	205	455	2550	1700	1275	1020	850	729	638	567	510	464	425	392	364	340	319
	S	48	106	596	397	298	238	198	170	149	132	119	108	99	91	85	79	74
240	T	205	455	2550	1700	1275	1020	850	729	638	567	510	464	425	392	364	340	319
	S	48	106	596	397	298	238	198	170	149	132	119	108	99	91	85	79	74
$k_1 \times b$ (-)	0,0	16,8	33,7	50,5	67,4	84,2	101,1	117,9	134,7	151,6	168,4	185,3	202,1	218,9	235,8	252,6	269,5	

Characteristic load-carrying capacity $F_{4/5,Rk}$ (N) for two angle brackets																		
b / e (mm)	0	20	40	60	80	100	120	140	160	180	200	220	240	260	280	300	320	
0	T	23999	23999	23999	23999	23999	23999	23999	23999	23999	23999	23999	23999	23999	23999	23999	23999	
	S	-	-	-	-	-	-	-	-	-	-	-	-	-	-	-	-	
20	T	23999	18912	9456	6304	4728	3782	3152	2702	2364	2101	1891	1719	1576	1455	1351	1261	1182
	S	-	57	28	19	14	11	9	8	7	6	5	5	4	4	4	3	3
40	T	23999	24000	18912	12608	9456	7565	6304	5403	4728	4203	3782	3439	3152	2910	2702	2522	2364
	S	-	115	57	38	28	23	19	16	14	12	11	10	9	8	8	7	7
60	T	23999	24000	24000	18912	14184	11347	9456	8105	7092	6304	5674	5158	4728	4364	4053	3782	3546
	S	-	173	86	57	43	34	28	24	21	19	17	15	14	13	12	11	10
80	T	23999	24000	24000	24000	18912	15130	12608	10807	9456	8405	7565	6877	6304	5819	5403	5043	4728
	S	-	231	115	77	57	46	38	33	28	25	23	21	19	17	16	15	14
100	T	23999	24000	24000	24000	23640	18912	15760	13509	11820	10507	9456	8596	7880	7274	6754	6304	5910
	S	-	288	144	96	72	57	48	41	36	32	28	26	24	22	20	19	18
120	T	23999	24000	24000	24000	24000	22694	18912	16210	14184	12608	11347	10316	9456	8729	8105	7565	7092
	S	-	346	173	115	86	69	57	49	43	38	34	31	28	26	24	23	21
140	T	23999	24000	24000	24000	24000	22064	18912	16548	14709	13238	12035	11032	10183	9456	8826	8274	
	S	-	404	202	134	101	80	67	57	50	44	40	36	33	31	28	26	25
160	T	23999	24000	24000	24000	24000	24000	21614	18912	16811	15130	13754	12608	11638	10807	10086	9456	
	S	-	462	231	154	115	92	77	66	57	51	46	42	38	35	33	30	28
180	T	23999	24000	24000	24000	24000	24000	24000	21276	18912	17021	15473	14184	13093	12158	11347	10638	
	S	-	519	259	173	129	103	86	74	64	57	51	47	43	39	37	34	32
200	T	23999	24000	24000	24000	24000	24000	24000	23640	21013	18912	17193	15760	14548	13509	12608	11820	
	S	-	577	288	192	144	115	96	82	72	64	57	52	48	44	41	38	36
220	T	23999	24000	24000	24000	24000	24000	24000	24000	23115	20803	18912	17336	16002	14859	13869	13002	
	S	-	635	317	211	158	127	105	90	79	70	63	57	52	48	45	42	39
240	T	23999	24000	24000	24000	24000	24000	24000	24000	24000	22694	20631	18912	17457	16210	15130	14184	
	S	-	693	346	231	173	138	115	99	86	77	69	63	57	53	49	46	43
$k_2 \times b$ (-)	0,0	183,6	367,3	550,9	734,5	918,2	1101,8	1285,5	1469,1	1652,7	1836,4	2020,0	2203,6	2387,3	2570,9	2754,5	2938,2	

TTM: Timber-Timber-Maximum | TTP: Timber-Timber-Partial | TCM: Timber-Concrete-Maximum | TCP: Timber-Concrete-Partial
T: $F_{1,T,Rk}$ load-carrying capacity of timber | S: $F_{1,S,Rk}$ load-carrying capacity of steel

Table B. 68 Angle bracket type 6504S, Variant TCM, Fastener GH Screw 5x40, Density 350 kg/m³Characteristic load-carrying capacity $F_{1,Rk}$ (N) for one / two angle brackets

angle bracket		1													2
f (mm)		0	10	20	30	40	50	60	70	80	90	100	110	120	0
$F_{1,Rk}$	T	16024	945	473	315	236	189	158	135	118	105	95	86	79	32048
	S	57	48	41	36	32	29	26	24	21	19	17	15	14	
k_t (-)		9,2	11,0	12,8	14,6	16,5	18,3	20,1	21,9	23,7	25,5	27,4	29,2	31,0	4,6

Characteristic load-carrying capacity $F_{2/3,Rk}$ (N) for one / two angle brackets

angle bracket		1	2
$F_{2/3,Rk}$	T	3740	7480
	S	-	-

Characteristic load-carrying capacity $F_{4,Rk}$ (N) for one angle bracket

e (mm)		0	20	40	60	80	100	120	140	160	180	200	220	240	260	280	300	320
$F_{4,Rk}$	T	-	-	2700	402	217	149	113	91	77	66	58	51	46	42	39	36	33
	S	-	145	72	48	36	27	21	16	14	12	10	9	8	7	7	6	6
k_t (-)		0,0	3,6	7,3	10,9	14,5	18,2	21,8	25,5	29,1	32,7	36,4	40,0	43,6	47,3	50,9	54,5	58,2

Characteristic load-carrying capacity $F_{5,Rk}$ (N) for one angle bracket

b / e (mm)		0	20	40	60	80	100	120	140	160	180	200	220	240	260	280	300	320
0	T	259	573	3213	2142	1607	1285	1071	918	803	714	643	584	536	494	459	428	402
	S	48	106	596	397	298	238	198	170	149	132	119	108	99	91	85	79	74
20	T	259	573	3213	2142	1607	1285	1071	918	803	714	643	584	536	494	459	428	402
	S	48	106	596	397	298	238	198	170	149	132	119	108	99	91	85	79	74
40	T	259	573	3213	2142	1607	1285	1071	918	803	714	643	584	536	494	459	428	402
	S	48	106	596	397	298	238	198	170	149	132	119	108	99	91	85	79	74
60	T	259	573	3213	2142	1607	1285	1071	918	803	714	643	584	536	494	459	428	402
	S	48	106	596	397	298	238	198	170	149	132	119	108	99	91	85	79	74
80	T	259	573	3213	2142	1607	1285	1071	918	803	714	643	584	536	494	459	428	402
	S	48	106	596	397	298	238	198	170	149	132	119	108	99	91	85	79	74
100	T	259	573	3213	2142	1607	1285	1071	918	803	714	643	584	536	494	459	428	402
	S	48	106	596	397	298	238	198	170	149	132	119	108	99	91	85	79	74
120	T	259	573	3213	2142	1607	1285	1071	918	803	714	643	584	536	494	459	428	402
	S	48	106	596	397	298	238	198	170	149	132	119	108	99	91	85	79	74
140	T	259	573	3213	2142	1607	1285	1071	918	803	714	643	584	536	494	459	428	402
	S	48	106	596	397	298	238	198	170	149	132	119	108	99	91	85	79	74
160	T	259	573	3213	2142	1607	1285	1071	918	803	714	643	584	536	494	459	428	402
	S	48	106	596	397	298	238	198	170	149	132	119	108	99	91	85	79	74
180	T	259	573	3213	2142	1607	1285	1071	918	803	714	643	584	536	494	459	428	402
	S	48	106	596	397	298	238	198	170	149	132	119	108	99	91	85	79	74
200	T	259	573	3213	2142	1607	1285	1071	918	803	714	643	584	536	494	459	428	402
	S	48	106	596	397	298	238	198	170	149	132	119	108	99	91	85	79	74
220	T	259	573	3213	2142	1607	1285	1071	918	803	714	643	584	536	494	459	428	402
	S	48	106	596	397	298	238	198	170	149	132	119	108	99	91	85	79	74
240	T	259	573	3213	2142	1607	1285	1071	918	803	714	643	584	536	494	459	428	402
	S	48	106	596	397	298	238	198	170	149	132	119	108	99	91	85	79	74
$k_t \times b$ (-)		0,0	16,8	33,7	50,5	67,4	84,2	101,1	117,9	134,7	151,6	168,4	185,3	202,1	218,9	235,8	252,6	269,5

Characteristic load-carrying capacity $F_{4/5,Rk}$ (N) for two angle brackets

b / e (mm)		0	20	40	60	80	100	120	140	160	180	200	220	240	260	280	300	320
0	T	30239	30239	30239	30239	30239	30239	30239	30239	30239	30239	30239	30239	30239	30239	30239	30239	30239
	S	-	-	-	-	-	-	-	-	-	-	-	-	-	-	-	-	-
20	T	30239	16024	8012	5341	4006	3205	2671	2289	2003	1780	1602	1457	1335	1233	1145	1068	1002
	S	-	57	28	19	14	11	9	8	7	6	5	5	4	4	4	3	3
40	T	30239	30240	16024	10683	8012	6410	5341	4578	4006	3561	3205	2913	2671	2465	2289	2137	2003
	S	-	115	57	38	28	23	19	16	14	12	11	10	9	8	8	7	7
60	T	30239	30240	24036	16024	12018	9614	8012	6867	6009	5341	4807	4370	4006	3698	3434	3205	3005
	S	-	173	86	57	43	34	28	24	21	19	17	15	14	13	12	11	10
80	T	30239	30240	30240	21365	16024	12819	10683	9157	8012	7122	6410	5827	5341	4930	4578	4273	4006
	S	-	231	115	77	57	46	38	33	28	25	23	21	19	17	16	15	14
100	T	30239	30240	30240	26707	20030	16024	13353	11446	10015	8902	8012	7284	6677	6163	5723	5341	5008
	S	-	288	144	96	72	57	48	41	36	32	28	26	24	22	20	19	18
120	T	30239	30240	30240	30240	24036	19229	16024	13735	12018	10683	9614	8740	8012	7396	6867	6410	6009
	S	-	346	173	115	86	69	57	49	43	38	34	31	28	26	24	23	21
140	T	30239	30240	30240	30240	28042	22434	18695	16024	14021	12463	11217	10197	9347	8628	8012	7478	7011
	S	-	404	202	134	101	80	67	57	50	44	40	36	33	31	28	26	25
160	T	30239	30240	30240	30240	30240	25638	21365	18313	16024	14244	12819	11654	10683	9861	9157	8546	8012
	S	-	462	231	154	115	92	77	66	57	51	46	42	38	35	33	30	28
180	T	30239	30240	30240	30240	30240	28843	24036	20602	18027	16024	14422	13111	12018	11094	10301	9614	9014
	S	-	519	259	173	129	103	86	74	64	57	51	47	43	39	37	34	32
200	T	30239	30240	30240	30240	30240	26707	22891	20030	17804	16024	14567	13353	12326	11446	10683	10015	10015
	S	-	577	288	192	144	115	96	82	72	64	57	52	48	44	41	38	36
220	T	30239	30240	30240	30240	30240	29377	25181	22033	19585	17626	16024	14689	13559	12590	11751	11017	11017
	S	-	635	317	211	158	127	105	90	79	70	63	57	52	48	45	42	39
240	T	30239	30240	30240	30240	30240	30240	27470	24036	21365	19229	17481	16024	14791	13735	12819	12018	12018
	S	-	693	346	231	173	138	115	99	86	77	69	63	57	53	49	46	43
$k_t \times b$ (-)		0,0	183,6	367,3	550,9	734,5	918,2	1101,8	1285,5	1469,1	1652,7	1836,4	2020,0	2203,6	2387,3	2570,9	2754,5	2938,2

TTM: Timber-Timber-Maximum | TTP: Timber-Timber-Partial | TCM: Timber-Concrete-Maximum | TCP: Timber-Concrete-Partial

T: $F_{1,T,Rk}$ load-carrying capacity of timber | S: $F_{1,S,Rk}$ load-carrying capacity of steel

Table B. 69 Angle bracket type 6504S, Variant TCM, Fastener GH Screw 5x60, Density 350 kg/m³Characteristic load-carrying capacity $F_{1,Rk}$ (N) for one / two angle brackets

angle bracket	1													2	
f (mm)	0	10	20	30	40	50	60	70	80	90	100	110	120	0	
$F_{1,Rk}$	T	18120	1470	735	490	368	294	245	210	184	163	147	134	123	36240
	S	57	48	41	36	32	29	26	24	21	19	17	15	14	114
k_1 (-)	9,2	11,0	12,8	14,6	16,5	18,3	20,1	21,9	23,7	25,5	27,4	29,2	31,0	4,6	

Characteristic load-carrying capacity $F_{2/3,Rk}$ (N) for one / two angle brackets

angle bracket	1	2	
$F_{2/3,Rk}$	T	4570	9140
	S	-	-

Characteristic load-carrying capacity $F_{4,Rk}$ (N) for one angle bracket

e (mm)	0	20	40	60	80	100	120	140	160	180	200	220	240	260	280	300	320	
$F_{4,Rk}$	T	-	-	4200	626	338	231	176	142	119	102	90	80	72	66	60	56	52
	S	-	145	72	48	36	27	21	16	14	12	10	9	8	7	7	6	6
k_1 (-)	0,0	3,6	7,3	10,9	14,5	18,2	21,8	25,5	29,1	32,7	36,4	40,0	43,6	47,3	50,9	54,5	58,2	

Characteristic load-carrying capacity $F_{5,Rk}$ (N) for one angle bracket

b / e (mm)	0	20	40	60	80	100	120	140	160	180	200	220	240	260	280	300	320	
0	T	403	891	4998	3332	2499	1999	1666	1428	1250	1111	1000	909	833	769	714	666	625
	S	48	106	596	397	298	238	198	170	149	132	119	108	99	91	85	79	74
20	T	403	891	4998	3332	2499	1999	1666	1428	1250	1111	1000	909	833	769	714	666	625
	S	48	106	596	397	298	238	198	170	149	132	119	108	99	91	85	79	74
40	T	403	891	4998	3332	2499	1999	1666	1428	1250	1111	1000	909	833	769	714	666	625
	S	48	106	596	397	298	238	198	170	149	132	119	108	99	91	85	79	74
60	T	403	891	4998	3332	2499	1999	1666	1428	1250	1111	1000	909	833	769	714	666	625
	S	48	106	596	397	298	238	198	170	149	132	119	108	99	91	85	79	74
80	T	403	891	4998	3332	2499	1999	1666	1428	1250	1111	1000	909	833	769	714	666	625
	S	48	106	596	397	298	238	198	170	149	132	119	108	99	91	85	79	74
100	T	403	891	4998	3332	2499	1999	1666	1428	1250	1111	1000	909	833	769	714	666	625
	S	48	106	596	397	298	238	198	170	149	132	119	108	99	91	85	79	74
120	T	403	891	4998	3332	2499	1999	1666	1428	1250	1111	1000	909	833	769	714	666	625
	S	48	106	596	397	298	238	198	170	149	132	119	108	99	91	85	79	74
140	T	403	891	4998	3332	2499	1999	1666	1428	1250	1111	1000	909	833	769	714	666	625
	S	48	106	596	397	298	238	198	170	149	132	119	108	99	91	85	79	74
160	T	403	891	4998	3332	2499	1999	1666	1428	1250	1111	1000	909	833	769	714	666	625
	S	48	106	596	397	298	238	198	170	149	132	119	108	99	91	85	79	74
180	T	403	891	4998	3332	2499	1999	1666	1428	1250	1111	1000	909	833	769	714	666	625
	S	48	106	596	397	298	238	198	170	149	132	119	108	99	91	85	79	74
200	T	403	891	4998	3332	2499	1999	1666	1428	1250	1111	1000	909	833	769	714	666	625
	S	48	106	596	397	298	238	198	170	149	132	119	108	99	91	85	79	74
220	T	403	891	4998	3332	2499	1999	1666	1428	1250	1111	1000	909	833	769	714	666	625
	S	48	106	596	397	298	238	198	170	149	132	119	108	99	91	85	79	74
240	T	403	891	4998	3332	2499	1999	1666	1428	1250	1111	1000	909	833	769	714	666	625
	S	48	106	596	397	298	238	198	170	149	132	119	108	99	91	85	79	74
$k_1 \times b$ (-)	0,0	16,8	33,7	50,5	67,4	84,2	101,1	117,9	134,7	151,6	168,4	185,3	202,1	218,9	235,8	252,6	269,5	

Characteristic load-carrying capacity $F_{4/5,Rk}$ (N) for two angle brackets

b / e (mm)	0	20	40	60	80	100	120	140	160	180	200	220	240	260	280	300	320	
0	T	47040	47040	47040	47040	47040	47040	47040	47040	47040	47040	47040	47040	47040	47040	47040	47040	
	S	-	-	-	-	-	-	-	-	-	-	-	-	-	-	-	-	
20	T	47040	18120	9060	6040	4530	3624	3020	2589	2265	2013	1812	1647	1510	1394	1294	1208	1133
	S	-	57	28	19	14	11	9	8	7	6	5	5	4	4	4	3	3
40	T	47040	36240	18120	12080	9060	7248	6040	5177	4530	4027	3624	3295	3020	2788	2589	2416	2265
	S	-	115	57	38	28	23	19	16	14	12	11	10	9	8	8	7	7
60	T	47040	47040	27180	18120	13590	10872	9060	7766	6795	6040	5436	4942	4530	4182	3883	3624	3398
	S	-	173	86	57	43	34	28	24	21	19	17	15	14	13	12	11	10
80	T	47040	47040	36240	24160	18120	14496	12080	10354	9060	8053	7248	6589	6040	5575	5177	4832	4530
	S	-	231	115	77	57	46	38	33	28	25	23	21	19	17	16	15	14
100	T	47040	47040	45300	30200	22650	18120	15100	12943	11325	10067	9060	8236	7550	6969	6471	6040	5663
	S	-	288	144	96	72	57	48	41	36	32	28	26	24	22	20	19	18
120	T	47040	47040	47040	36240	27180	21744	18120	15531	13590	12080	10872	9884	9060	8363	7766	7248	6795
	S	-	346	173	115	86	69	57	49	43	38	34	31	28	26	24	23	21
140	T	47040	47040	47040	42280	31710	25368	21140	18120	15855	14093	12684	11531	10570	9757	9060	8456	7928
	S	-	404	202	134	101	80	67	57	50	44	40	36	33	31	28	26	25
160	T	47040	47040	47040	47040	36240	28992	24160	20709	18120	16107	14496	13178	12080	11151	10354	9664	9060
	S	-	462	231	154	115	92	77	66	57	51	46	42	38	35	33	30	28
180	T	47040	47040	47040	47040	40770	32616	27180	23297	20385	18120	16308	14825	13590	12545	11649	10872	10193
	S	-	519	259	173	129	103	86	74	64	57	51	47	43	39	37	34	32
200	T	47040	47040	47040	47040	45300	36240	30200	25886	22650	20133	18120	16473	15100	13938	12943	12080	11325
	S	-	577	288	192	144	115	96	82	72	64	57	52	48	44	41	38	36
220	T	47040	47040	47040	47040	47040	39864	33220	28474	24915	22147	19932	18120	16610	15332	14237	13288	12458
	S	-	635	317	211	158	127	105	90	79	70	63	57	52	48	45	42	39
240	T	47040	47040	47040	47040	47040	43488	36240	31063	27180	24160	21744	19767	18120	16726	15531	14496	13590
	S	-	693	346	231	173	138	115	99	86	77	69	63	57	53	49	46	43
$k_1 \times b$ (-)	0,0	183,6	367,3	550,9	734,5	918,2	1101,8	1285,5	1469,1	1652,7	1836,4	2020,0	2203,6	2387,3	2570,9	2754,5	2938,2	

TTM: Timber-Timber-Maximum | TTP: Timber-Timber-Partial | TCM: Timber-Concrete-Maximum | TCP: Timber-Concrete-Partial

T: $F_{1,T,Rk}$ load-carrying capacity of timber | S: $F_{1,S,Rk}$ load-carrying capacity of steel

Table B. 70 Angle bracket type 6504S, Variant TCP, Fastener GH Nail 4x40, Density 350 kg/m³

Characteristic load-carrying capacity $F_{1,Rk}$ (N) for one / two angle brackets															
angle bracket	1													2	
f (mm)	0	10	20	30	40	50	60	70	80	90	100	110	120	0	
$F_{1,Rk}$	T	7560	450	225	150	113	90	75	64	56	50	45	41	38	15120
	S	57	48	41	36	32	29	26	24	21	19	17	15	14	114
k_1 (-)	9,2	11,0	12,8	14,6	16,5	18,3	20,1	21,9	23,7	25,5	27,4	29,2	31,0	4,6	

Characteristic load-carrying capacity $F_{2/3,Rk}$ (N) for one / two angle brackets			
angle bracket	1	2	
$F_{2/3,Rk}$	T	1400	2800
	S	-	-

Characteristic load-carrying capacity $F_{4,Rk}$ (N) for one angle bracket																	
e (mm)	0	20	40	60	80	100	120	140	160	180	200	220	240	260	280	300	320
$F_{4,Rk}$	T	-	-	1286	191	103	71	54	43	36	31	28	25	22	20	18	16
	S	-	145	72	48	36	27	21	16	14	12	10	9	8	7	7	6
k_1 (-)	0,0	3,6	7,3	10,9	14,5	18,2	21,8	25,5	29,1	32,7	36,4	40,0	43,6	47,3	50,9	54,5	58,2

Characteristic load-carrying capacity $F_{5,Rk}$ (N) for one angle bracket																	
b / e (mm)	0	20	40	60	80	100	120	140	160	180	200	220	240	260	280	300	320
0	T	123	273	1530	1020	765	612	510	437	383	340	306	278	255	235	219	191
	S	48	106	596	397	298	238	198	170	149	132	119	108	99	91	85	79
20	T	123	273	1530	1020	765	612	510	437	383	340	306	278	255	235	219	191
	S	48	106	596	397	298	238	198	170	149	132	119	108	99	91	85	79
40	T	123	273	1530	1020	765	612	510	437	383	340	306	278	255	235	219	191
	S	48	106	596	397	298	238	198	170	149	132	119	108	99	91	85	79
60	T	123	273	1530	1020	765	612	510	437	383	340	306	278	255	235	219	191
	S	48	106	596	397	298	238	198	170	149	132	119	108	99	91	85	79
80	T	123	273	1530	1020	765	612	510	437	383	340	306	278	255	235	219	191
	S	48	106	596	397	298	238	198	170	149	132	119	108	99	91	85	79
100	T	123	273	1530	1020	765	612	510	437	383	340	306	278	255	235	219	191
	S	48	106	596	397	298	238	198	170	149	132	119	108	99	91	85	79
120	T	123	273	1530	1020	765	612	510	437	383	340	306	278	255	235	219	191
	S	48	106	596	397	298	238	198	170	149	132	119	108	99	91	85	79
140	T	123	273	1530	1020	765	612	510	437	383	340	306	278	255	235	219	191
	S	48	106	596	397	298	238	198	170	149	132	119	108	99	91	85	79
160	T	123	273	1530	1020	765	612	510	437	383	340	306	278	255	235	219	191
	S	48	106	596	397	298	238	198	170	149	132	119	108	99	91	85	79
180	T	123	273	1530	1020	765	612	510	437	383	340	306	278	255	235	219	191
	S	48	106	596	397	298	238	198	170	149	132	119	108	99	91	85	79
200	T	123	273	1530	1020	765	612	510	437	383	340	306	278	255	235	219	191
	S	48	106	596	397	298	238	198	170	149	132	119	108	99	91	85	79
220	T	123	273	1530	1020	765	612	510	437	383	340	306	278	255	235	219	191
	S	48	106	596	397	298	238	198	170	149	132	119	108	99	91	85	79
240	T	123	273	1530	1020	765	612	510	437	383	340	306	278	255	235	219	191
	S	48	106	596	397	298	238	198	170	149	132	119	108	99	91	85	79
$k_1 \times b$ (-)	0,0	16,8	33,7	50,5	67,4	84,2	101,1	117,9	134,7	151,6	168,4	185,3	202,1	218,9	235,8	252,6	269,5

Characteristic load-carrying capacity $F_{4/5,Rk}$ (N) for two angle brackets																	
b / e (mm)	0	20	40	60	80	100	120	140	160	180	200	220	240	260	280	300	320
0	T	7199	7199	7199	7199	7199	7199	7199	7199	7199	7199	7199	7199	7199	7199	7199	7199
	S	-	-	-	-	-	-	-	-	-	-	-	-	-	-	-	-
20	T	7199	7200	3780	2520	1890	1512	1260	1080	945	840	756	687	630	582	540	473
	S	-	57	28	19	14	11	9	8	7	6	5	5	4	4	4	3
40	T	7199	7200	7200	5040	3780	3024	2520	2160	1890	1680	1512	1375	1260	1163	1080	945
	S	-	115	57	38	28	23	19	16	14	12	11	10	9	8	7	7
60	T	7199	7200	7200	7200	5670	4536	3780	3240	2835	2520	2268	2062	1890	1745	1620	1418
	S	-	173	86	57	43	34	28	24	21	19	17	15	14	13	12	11
80	T	7199	7200	7200	7200	7200	6048	5040	4320	3780	3360	3024	2749	2520	2326	2160	1890
	S	-	231	115	77	57	46	38	33	28	25	23	21	19	17	16	14
100	T	7199	7200	7200	7200	7200	6300	5400	4725	4200	3780	3436	3150	2908	2700	2520	2363
	S	-	288	144	96	72	57	48	41	36	32	28	26	24	22	20	19
120	T	7199	7200	7200	7200	7200	7200	7200	6480	5670	5040	4536	4124	3780	3489	3240	2835
	S	-	346	173	115	86	69	57	49	43	38	34	31	28	26	24	23
140	T	7199	7200	7200	7200	7200	7200	7200	6615	5880	5292	4811	4410	4071	3780	3528	3308
	S	-	404	202	134	101	80	67	57	50	44	40	36	33	31	28	25
160	T	7199	7200	7200	7200	7200	7200	7200	7200	6720	6048	5498	5040	4652	4320	4032	3780
	S	-	462	231	154	115	92	77	66	57	51	46	42	38	35	33	28
180	T	7199	7200	7200	7200	7200	7200	7200	7200	7200	7200	6804	6185	5670	5234	4860	4253
	S	-	519	259	173	129	103	86	74	64	57	51	47	43	39	37	32
200	T	7199	7200	7200	7200	7200	7200	7200	7200	7200	7200	7200	6873	6300	5815	5400	4725
	S	-	577	288	192	144	115	96	82	72	64	57	52	48	44	41	38
220	T	7199	7200	7200	7200	7200	7200	7200	7200	7200	7200	7200	7200	6930	6397	5940	5198
	S	-	635	317	211	158	127	105	90	79	70	63	57	52	48	45	39
240	T	7199	7200	7200	7200	7200	7200	7200	7200	7200	7200	7200	7200	7200	6978	6480	5670
	S	-	693	346	231	173	138	115	99	86	77	69	63	57	53	49	43
$k_1 \times b$ (-)	0,0	183,6	367,3	550,9	734,5	918,2	1101,8	1285,5	1469,1	1652,7	1836,4	2020,0	2203,6	2387,3	2570,9	2754,5	2938,2

TTM: Timber-Timber-Maximum | TTP: Timber-Timber-Partial | TCM: Timber-Concrete-Maximum | TCP: Timber-Concrete-Partial
T: $F_{1,T,Rk}$ load-carrying capacity of timber | S: $F_{1,S,Rk}$ load-carrying capacity of steel

Table B. 71 Angle bracket type 6504S, Variant TCP, Fastener GH Nail 4x60, Density 350 kg/m³

Characteristic load-carrying capacity F_{1,Rk} (N) for one / two angle brackets

angle bracket		1												2	
f (mm)		0	10	20	30	40	50	60	70	80	90	100	110	120	0
F _{1,Rk}	T	9456	750	375	250	188	150	125	107	94	83	75	68	63	18912
	S	57	48	41	36	32	29	26	24	21	19	17	15	14	114
k _t (-)		9,2	11,0	12,8	14,6	16,5	18,3	20,1	21,9	23,7	25,5	27,4	29,2	31,0	4,6

Characteristic load-carrying capacity F_{2/3,Rk} (N) for one / two angle brackets

angle bracket		1	2
F _{2/3,Rk}	T	2120	4240
	S	-	-

Characteristic load-carrying capacity F_{4,Rk} (N) for one angle bracket

e (mm)		0	20	40	60	80	100	120	140	160	180	200	220	240	260	280	300	320
F _{4,Rk}	T	-	-	2143	319	172	118	90	72	61	52	46	41	37	34	31	28	26
	S	-	145	72	48	36	27	21	16	14	12	10	9	8	7	7	6	6
k _t (-)		0,0	3,6	7,3	10,9	14,5	18,2	21,8	25,5	29,1	32,7	36,4	40,0	43,6	47,3	50,9	54,5	58,2

Characteristic load-carrying capacity F_{5,Rk} (N) for one angle bracket

b / e (mm)		0	20	40	60	80	100	120	140	160	180	200	220	240	260	280	300	320
0	T	205	455	2550	1700	1275	1020	850	729	638	567	510	464	425	392	364	340	319
	S	48	106	596	397	298	238	198	170	149	132	119	108	99	91	85	79	74
20	T	205	455	2550	1700	1275	1020	850	729	638	567	510	464	425	392	364	340	319
	S	48	106	596	397	298	238	198	170	149	132	119	108	99	91	85	79	74
40	T	205	455	2550	1700	1275	1020	850	729	638	567	510	464	425	392	364	340	319
	S	48	106	596	397	298	238	198	170	149	132	119	108	99	91	85	79	74
60	T	205	455	2550	1700	1275	1020	850	729	638	567	510	464	425	392	364	340	319
	S	48	106	596	397	298	238	198	170	149	132	119	108	99	91	85	79	74
80	T	205	455	2550	1700	1275	1020	850	729	638	567	510	464	425	392	364	340	319
	S	48	106	596	397	298	238	198	170	149	132	119	108	99	91	85	79	74
100	T	205	455	2550	1700	1275	1020	850	729	638	567	510	464	425	392	364	340	319
	S	48	106	596	397	298	238	198	170	149	132	119	108	99	91	85	79	74
120	T	205	455	2550	1700	1275	1020	850	729	638	567	510	464	425	392	364	340	319
	S	48	106	596	397	298	238	198	170	149	132	119	108	99	91	85	79	74
140	T	205	455	2550	1700	1275	1020	850	729	638	567	510	464	425	392	364	340	319
	S	48	106	596	397	298	238	198	170	149	132	119	108	99	91	85	79	74
160	T	205	455	2550	1700	1275	1020	850	729	638	567	510	464	425	392	364	340	319
	S	48	106	596	397	298	238	198	170	149	132	119	108	99	91	85	79	74
180	T	205	455	2550	1700	1275	1020	850	729	638	567	510	464	425	392	364	340	319
	S	48	106	596	397	298	238	198	170	149	132	119	108	99	91	85	79	74
200	T	205	455	2550	1700	1275	1020	850	729	638	567	510	464	425	392	364	340	319
	S	48	106	596	397	298	238	198	170	149	132	119	108	99	91	85	79	74
220	T	205	455	2550	1700	1275	1020	850	729	638	567	510	464	425	392	364	340	319
	S	48	106	596	397	298	238	198	170	149	132	119	108	99	91	85	79	74
240	T	205	455	2550	1700	1275	1020	850	729	638	567	510	464	425	392	364	340	319
	S	48	106	596	397	298	238	198	170	149	132	119	108	99	91	85	79	74
k _t x b (-)		0,0	16,8	33,7	50,5	67,4	84,2	101,1	117,9	134,7	151,6	168,4	185,3	202,1	218,9	235,8	252,6	269,5

Characteristic load-carrying capacity F_{4/5,Rk} (N) for two angle brackets

b / e (mm)		0	20	40	60	80	100	120	140	160	180	200	220	240	260	280	300	320
0	T	12000	12000	12000	12000	12000	12000	12000	12000	12000	12000	12000	12000	12000	12000	12000	12000	12000
	S	-	-	-	-	-	-	-	-	-	-	-	-	-	-	-	-	-
20	T	12000	9456	4728	3152	2364	1891	1576	1351	1182	1051	946	860	788	727	675	630	591
	S	-	57	28	19	14	11	9	8	7	6	5	5	4	4	4	3	3
40	T	12000	12000	9456	6304	4728	3782	3152	2702	2364	2101	1891	1719	1576	1455	1351	1261	1182
	S	-	115	57	38	28	23	19	16	14	12	11	10	9	8	8	7	7
60	T	12000	12000	12000	9456	7092	5674	4728	4053	3546	3152	2837	2579	2364	2182	2026	1891	1773
	S	-	173	86	57	43	34	28	24	21	19	17	15	14	13	12	11	10
80	T	12000	12000	12000	12000	9456	7565	6304	5403	4728	4203	3782	3439	3152	2910	2702	2522	2364
	S	-	231	115	77	57	46	38	33	28	25	23	21	19	17	16	15	14
100	T	12000	12000	12000	12000	11820	9456	7880	6754	5910	5253	4728	4298	3940	3637	3377	3152	2955
	S	-	288	144	96	72	57	48	41	36	32	28	26	24	22	20	19	18
120	T	12000	12000	12000	12000	11347	9456	8105	7092	6304	5674	5158	4728	4364	4053	3782	3546	3346
	S	-	346	173	115	86	69	57	49	43	38	34	31	28	26	24	23	21
140	T	12000	12000	12000	12000	12000	11032	9456	8274	7355	6619	6017	5516	5092	4728	4413	4137	3917
	S	-	404	202	134	101	80	67	57	50	44	40	36	33	31	28	26	25
160	T	12000	12000	12000	12000	12000	12000	10807	9456	8405	7565	6877	6304	5819	5403	5043	4728	4478
	S	-	462	231	154	115	92	77	66	57	51	46	42	38	35	33	30	28
180	T	12000	12000	12000	12000	12000	12000	12000	10638	9456	8510	7737	7092	6546	6079	5674	5319	5019
	S	-	519	259	173	129	103	86	74	64	57	51	47	43	39	37	34	32
200	T	12000	12000	12000	12000	12000	12000	12000	11820	10507	9456	8596	7880	7274	6754	6304	5910	5510
	S	-	577	288	192	144	115	96	82	72	64	57	52	48	44	41	38	36
220	T	12000	12000	12000	12000	12000	12000	12000	12000	11557	10402	9456	8668	8001	7430	6934	6501	6101
	S	-	635	317	211	158	127	105	90	79	70	63	57	52	48	45	42	39
240	T	12000	12000	12000	12000	12000	12000	12000	12000	12000	12000	11347	10316	9456	8729	8105	7565	7092
	S	-	693	346	231	173	138	115	99	86	77	69	63	57	53	49	46	43
k _t x b (-)		0,0	183,6	367,3	550,9	734,5	918,2	1101,8	1285,5	1469,1	1652,7	1836,4	2020,0	2203,6	2387,3	2570,9	2754,5	2938,2

TTM: Timber-Timber-Maximum | TTP: Timber-Timber-Partial | TCM: Timber-Concrete-Maximum | TCP: Timber-Concrete-Partial

T: F_{1,T,Rk} load-carrying capacity of timber | S: F_{1,S,Rk} load-carrying capacity of steel

Table B. 72 Angle bracket type 6504S, Variant TCP, Fastener GH Screw 5x40, Density 350 kg/m³Characteristic load-carrying capacity $F_{1,Rk}$ (N) for one / two angle brackets

angle bracket	1													2	
f (mm)	0	10	20	30	40	50	60	70	80	90	100	110	120	0	
$F_{1,Rk}$	T	8012	945	473	315	236	189	158	135	118	105	95	86	79	16024
	S	57	48	41	36	32	29	26	24	21	19	17	15	14	114
k_1 (-)	9,2	11,0	12,8	14,6	16,5	18,3	20,1	21,9	23,7	25,5	27,4	29,2	31,0	4,6	

Characteristic load-carrying capacity $F_{2/3,Rk}$ (N) for one / two angle brackets

angle bracket	1	2	
$F_{2/3,Rk}$	T	2190	4380
	S	-	-

Characteristic load-carrying capacity $F_{4,Rk}$ (N) for one angle bracket

e (mm)	0	20	40	60	80	100	120	140	160	180	200	220	240	260	280	300	320	
$F_{4,Rk}$	T	-	-	2700	402	217	149	113	91	77	66	58	51	46	42	39	36	33
	S	-	145	72	48	36	27	21	16	14	12	10	9	8	7	7	6	6
k_1 (-)	0,0	3,6	7,3	10,9	14,5	18,2	21,8	25,5	29,1	32,7	36,4	40,0	43,6	47,3	50,9	54,5	58,2	

Characteristic load-carrying capacity $F_{5,Rk}$ (N) for one angle bracket

b / e (mm)	0	20	40	60	80	100	120	140	160	180	200	220	240	260	280	300	320	
0	T	259	573	3213	2142	1607	1285	1071	918	803	714	643	584	536	494	459	428	402
	S	48	106	596	397	298	238	198	170	149	132	119	108	99	91	85	79	74
20	T	259	573	3213	2142	1607	1285	1071	918	803	714	643	584	536	494	459	428	402
	S	48	106	596	397	298	238	198	170	149	132	119	108	99	91	85	79	74
40	T	259	573	3213	2142	1607	1285	1071	918	803	714	643	584	536	494	459	428	402
	S	48	106	596	397	298	238	198	170	149	132	119	108	99	91	85	79	74
60	T	259	573	3213	2142	1607	1285	1071	918	803	714	643	584	536	494	459	428	402
	S	48	106	596	397	298	238	198	170	149	132	119	108	99	91	85	79	74
80	T	259	573	3213	2142	1607	1285	1071	918	803	714	643	584	536	494	459	428	402
	S	48	106	596	397	298	238	198	170	149	132	119	108	99	91	85	79	74
100	T	259	573	3213	2142	1607	1285	1071	918	803	714	643	584	536	494	459	428	402
	S	48	106	596	397	298	238	198	170	149	132	119	108	99	91	85	79	74
120	T	259	573	3213	2142	1607	1285	1071	918	803	714	643	584	536	494	459	428	402
	S	48	106	596	397	298	238	198	170	149	132	119	108	99	91	85	79	74
140	T	259	573	3213	2142	1607	1285	1071	918	803	714	643	584	536	494	459	428	402
	S	48	106	596	397	298	238	198	170	149	132	119	108	99	91	85	79	74
160	T	259	573	3213	2142	1607	1285	1071	918	803	714	643	584	536	494	459	428	402
	S	48	106	596	397	298	238	198	170	149	132	119	108	99	91	85	79	74
180	T	259	573	3213	2142	1607	1285	1071	918	803	714	643	584	536	494	459	428	402
	S	48	106	596	397	298	238	198	170	149	132	119	108	99	91	85	79	74
200	T	259	573	3213	2142	1607	1285	1071	918	803	714	643	584	536	494	459	428	402
	S	48	106	596	397	298	238	198	170	149	132	119	108	99	91	85	79	74
220	T	259	573	3213	2142	1607	1285	1071	918	803	714	643	584	536	494	459	428	402
	S	48	106	596	397	298	238	198	170	149	132	119	108	99	91	85	79	74
240	T	259	573	3213	2142	1607	1285	1071	918	803	714	643	584	536	494	459	428	402
	S	48	106	596	397	298	238	198	170	149	132	119	108	99	91	85	79	74
$k_1 \times b$ (-)	0,0	16,8	33,7	50,5	67,4	84,2	101,1	117,9	134,7	151,6	168,4	185,3	202,1	218,9	235,8	252,6	269,5	

Characteristic load-carrying capacity $F_{4/5,Rk}$ (N) for two angle brackets

b / e (mm)	0	20	40	60	80	100	120	140	160	180	200	220	240	260	280	300	320	
0	T	15120	15120	15120	15120	15120	15120	15120	15120	15120	15120	15120	15120	15120	15120	15120	15120	
	S	-	-	-	-	-	-	-	-	-	-	-	-	-	-	-	-	
20	T	15120	8012	4006	2671	2003	1602	1335	1145	1002	890	801	728	668	616	572	534	501
	S	-	57	28	19	14	11	9	8	7	6	5	5	4	4	4	3	3
40	T	15120	15120	8012	5341	4006	3205	2671	2289	2003	1780	1602	1457	1335	1233	1145	1068	1002
	S	-	115	57	38	28	23	19	16	14	12	11	10	9	8	8	7	7
60	T	15120	15120	12018	8012	6009	4807	4006	3434	3005	2671	2404	2185	2003	1849	1717	1602	1502
	S	-	173	86	57	43	34	28	24	21	19	17	15	14	13	12	11	10
80	T	15120	15120	15120	10683	8012	6410	5341	4578	4006	3561	3205	2913	2671	2465	2289	2137	2003
	S	-	231	115	77	57	46	38	33	28	25	23	21	19	17	16	15	14
100	T	15120	15120	15120	13353	10015	8012	6677	5723	5008	4451	4006	3642	3338	3082	2861	2671	2504
	S	-	288	144	96	72	57	48	41	36	32	28	26	24	22	20	19	18
120	T	15120	15120	15120	15120	12018	9614	8012	6867	6009	5341	4807	4370	4006	3698	3434	3205	3005
	S	-	346	173	115	86	69	57	49	43	38	34	31	28	26	24	23	21
140	T	15120	15120	15120	15120	14021	11217	9347	8012	7011	6232	5608	5099	4674	4314	4006	3739	3505
	S	-	404	202	134	101	80	67	57	50	44	40	36	33	31	28	26	25
160	T	15120	15120	15120	15120	12819	10683	9157	8012	7122	6410	5827	5341	4930	4578	4273	4006	3806
	S	-	462	231	154	115	92	77	66	57	51	46	42	38	35	33	30	28
180	T	15120	15120	15120	15120	15120	14422	12018	10301	9014	8012	7211	6555	6009	5547	5151	4807	4507
	S	-	519	259	173	129	103	86	74	64	57	51	47	43	39	37	34	32
200	T	15120	15120	15120	15120	15120	13353	11446	10015	8902	8012	7284	6677	6163	5723	5341	5008	4806
	S	-	577	288	192	144	115	96	82	72	64	57	52	48	44	41	38	36
220	T	15120	15120	15120	15120	15120	14689	12590	11017	9792	8813	8012	7344	6779	6295	5875	5508	5208
	S	-	635	317	211	158	127	105	90	79	70	63	57	52	48	45	42	39
240	T	15120	15120	15120	15120	15120	15120	13735	12018	10683	9614	8740	8012	7396	6867	6410	6009	5809
	S	-	693	346	231	173	138	115	99	86	77	69	63	57	53	49	46	43
$k_2 \times b$ (-)	0,0	183,6	367,3	550,9	734,5	918,2	1101,8	1285,5	1469,1	1652,7	1836,4	2020,0	2203,6	2387,3	2570,9	2754,5	2938,2	

TTM: Timber-Timber-Maximum | TTP: Timber-Timber-Partial | TCM: Timber-Concrete-Maximum | TCP: Timber-Concrete-Partial

T: $F_{1,T,Rk}$ load-carrying capacity of timber | S: $F_{1,S,Rk}$ load-carrying capacity of steel

Table B. 73 Angle bracket type 6504S, Variant TCP, Fastener GH Screw 5x60, Density 350 kg/m³Characteristic load-carrying capacity $F_{1,Rk}$ (N) for one / two angle brackets

angle bracket	1													2	
f (mm)	0	10	20	30	40	50	60	70	80	90	100	110	120	0	
$F_{1,Rk}$	T	9060	1470	735	490	368	294	245	210	184	163	147	134	123	18120
	S	57	48	41	36	32	29	26	24	21	19	17	15	14	114
k_t (-)	9,2	11,0	12,8	14,6	16,5	18,3	20,1	21,9	23,7	25,5	27,4	29,2	31,0	4,6	

Characteristic load-carrying capacity $F_{2/3,Rk}$ (N) for one / two angle brackets

angle bracket	1	2	
$F_{2/3,Rk}$	T	2750	5500
	S	-	-

Characteristic load-carrying capacity $F_{4,Rk}$ (N) for one angle bracket

e (mm)	0	20	40	60	80	100	120	140	160	180	200	220	240	260	280	300	320	
$F_{4,Rk}$	T	-	-	4200	626	338	231	176	142	119	102	90	80	72	66	60	56	52
	S	-	145	72	48	36	27	21	16	14	12	10	9	8	7	7	6	6
k_t (-)	0,0	3,6	7,3	10,9	14,5	18,2	21,8	25,5	29,1	32,7	36,4	40,0	43,6	47,3	50,9	54,5	58,2	

Characteristic load-carrying capacity $F_{5,Rk}$ (N) for one angle bracket

b / e (mm)	0	20	40	60	80	100	120	140	160	180	200	220	240	260	280	300	320	
0	T	403	891	4998	3332	2499	1999	1666	1428	1250	1111	1000	909	833	769	714	666	625
	S	48	106	596	397	298	238	198	170	149	132	119	108	99	91	85	79	74
20	T	403	891	4530	3020	2265	1812	1510	1294	1133	1007	906	824	755	697	647	604	566
	S	48	106	596	397	298	238	198	170	149	132	119	108	99	91	85	79	74
40	T	403	891	4998	3332	2499	1999	1666	1428	1250	1111	1000	909	833	769	714	666	625
	S	48	106	596	397	298	238	198	170	149	132	119	108	99	91	85	79	74
60	T	403	891	4998	3332	2499	1999	1666	1428	1250	1111	1000	909	833	769	714	666	625
	S	48	106	596	397	298	238	198	170	149	132	119	108	99	91	85	79	74
80	T	403	891	4998	3332	2499	1999	1666	1428	1250	1111	1000	909	833	769	714	666	625
	S	48	106	596	397	298	238	198	170	149	132	119	108	99	91	85	79	74
100	T	403	891	4998	3332	2499	1999	1666	1428	1250	1111	1000	909	833	769	714	666	625
	S	48	106	596	397	298	238	198	170	149	132	119	108	99	91	85	79	74
120	T	403	891	4998	3332	2499	1999	1666	1428	1250	1111	1000	909	833	769	714	666	625
	S	48	106	596	397	298	238	198	170	149	132	119	108	99	91	85	79	74
140	T	403	891	4998	3332	2499	1999	1666	1428	1250	1111	1000	909	833	769	714	666	625
	S	48	106	596	397	298	238	198	170	149	132	119	108	99	91	85	79	74
160	T	403	891	4998	3332	2499	1999	1666	1428	1250	1111	1000	909	833	769	714	666	625
	S	48	106	596	397	298	238	198	170	149	132	119	108	99	91	85	79	74
180	T	403	891	4998	3332	2499	1999	1666	1428	1250	1111	1000	909	833	769	714	666	625
	S	48	106	596	397	298	238	198	170	149	132	119	108	99	91	85	79	74
200	T	403	891	4998	3332	2499	1999	1666	1428	1250	1111	1000	909	833	769	714	666	625
	S	48	106	596	397	298	238	198	170	149	132	119	108	99	91	85	79	74
220	T	403	891	4998	3332	2499	1999	1666	1428	1250	1111	1000	909	833	769	714	666	625
	S	48	106	596	397	298	238	198	170	149	132	119	108	99	91	85	79	74
240	T	403	891	4998	3332	2499	1999	1666	1428	1250	1111	1000	909	833	769	714	666	625
	S	48	106	596	397	298	238	198	170	149	132	119	108	99	91	85	79	74
$k_t \times b$ (-)	0,0	16,8	33,7	50,5	67,4	84,2	101,1	117,9	134,7	151,6	168,4	185,3	202,1	218,9	235,8	252,6	269,5	

Characteristic load-carrying capacity $F_{4/5,Rk}$ (N) for two angle brackets

b / e (mm)	0	20	40	60	80	100	120	140	160	180	200	220	240	260	280	300	320	
0	T	23519	23519	23519	23519	23519	23519	23519	23519	23519	23519	23519	23519	23519	23519	23519	23519	
	S	-	-	-	-	-	-	-	-	-	-	-	-	-	-	-	-	
20	T	23519	9060	4530	3020	2265	1812	1510	1294	1133	1007	906	824	755	697	647	604	566
	S	-	57	28	19	14	11	9	8	7	6	5	5	4	4	4	3	3
40	T	23519	18120	9060	6040	4530	3624	3020	2589	2265	2013	1812	1647	1510	1394	1294	1208	1133
	S	-	115	57	38	28	23	19	16	14	12	11	10	9	8	8	7	7
60	T	23519	23520	13590	9060	6795	5436	4530	3883	3398	3020	2718	2471	2265	2091	1941	1812	1699
	S	-	173	86	57	43	34	28	24	21	19	17	15	14	13	12	11	10
80	T	23519	23520	18120	12080	9060	7248	6040	5177	4530	4027	3624	3295	3020	2788	2589	2416	2265
	S	-	231	115	77	57	46	38	33	28	25	23	21	19	17	16	15	14
100	T	23519	23520	22650	15100	11325	9060	7550	6471	5663	5033	4530	4118	3775	3485	3236	3020	2831
	S	-	288	144	96	72	57	48	41	36	32	28	26	24	22	20	19	18
120	T	23519	23520	23520	18120	13590	10872	9060	7766	6795	6040	5436	4942	4530	4182	3883	3624	3398
	S	-	346	173	115	86	69	57	49	43	38	34	31	28	26	24	23	21
140	T	23519	23520	23520	21140	15855	12684	10570	9060	7928	7047	6342	5765	5285	4878	4530	4228	3964
	S	-	404	202	134	101	80	67	57	50	44	40	36	33	31	28	26	25
160	T	23519	23520	23520	23520	18120	14496	12080	10354	9060	8053	7248	6589	6040	5575	5177	4832	4530
	S	-	462	231	154	115	92	77	66	57	51	46	42	38	35	33	30	28
180	T	23519	23520	23520	23520	20385	16308	13590	11649	10193	9060	8154	7413	6795	6272	5824	5436	5096
	S	-	519	259	173	129	103	86	74	64	57	51	47	43	39	37	34	32
200	T	23519	23520	23520	23520	22650	18120	15100	12943	11325	10067	9060	8236	7550	6969	6471	6040	5663
	S	-	577	288	192	144	115	96	82	72	64	57	52	48	44	41	38	36
220	T	23519	23520	23520	23520	23520	19932	16610	14237	12458	11073	9966	9060	8305	7666	7119	6644	6229
	S	-	635	317	211	158	127	105	90	79	70	63	57	52	48	45	42	39
240	T	23519	23520	23520	23520	23520	21744	18120	15531	13590	12080	10872	9884	9060	8363	7766	7248	6795
	S	-	693	346	231	173	138	115	99	86	77	69	63	57	53	49	46	43
$k_t \times b$ (-)	0,0	183,6	367,3	550,9	734,5	918,2	1101,8	1285,5	1469,1	1652,7	1836,4	2020,0	2203,6	2387,3	2570,9	2754,5	2938,2	

TTM: Timber-Timber-Maximum | TTP: Timber-Timber-Partial | TCM: Timber-Concrete-Maximum | TCP: Timber-Concrete-Partial

T: $F_{1,T,Rk}$ load-carrying capacity of timber | S: $F_{1,S,Rk}$ load-carrying capacity of steel

Table B. 74 Angle bracket type 6504S, Variant TTM, Fastener GH Nail 4x40, Density 350 kg/m³Characteristic load-carrying capacity $F_{T,Rk}$ (N) for one / two angle brackets

angle bracket		1													2
f (mm)		0	10	20	30	40	50	60	70	80	90	100	110	120	0
$F_{T,Rk}$	T	486	316	225	150	113	90	75	64	56	50	45	41	38	973
	S	201	130	87	58	43	35	29	25	21	19	17	15	14	402

Characteristic load-carrying capacity $F_{2/3,Rk}$ (N) for one / two angle brackets

angle bracket		1	2
$F_{2/3,Rk}$	T	6000	12000
	S	-	-

Characteristic load-carrying capacity $F_{4,Rk}$ (N) for one angle bracket

e (mm)		0	20	40	60	80	100	120	140	160	180	200	220	240	260	280	300	320
$F_{4,Rk}$	T	22679	450	225	150	103	71	54	43	36	31	28	25	22	20	18	17	16
	S	-	186	93	62	40	27	21	16	14	12	10	9	8	7	7	6	6

Characteristic load-carrying capacity $F_{5,Rk}$ (N) for one angle bracket

b / e (mm)		0	20	40	60	80	100	120	140	160	180	200	220	240	260	280	300	320
0	T	123	273	1440	960	720	576	480	411	360	320	288	262	240	222	206	192	180
	S	48	106	596	397	298	238	198	170	149	132	119	108	99	91	85	79	74
20	T	123	273	1530	1020	765	612	510	437	383	340	306	278	255	235	219	204	191
	S	48	106	596	397	298	238	198	170	149	132	119	108	99	91	85	79	74
40	T	123	273	1530	1020	765	612	510	437	383	340	306	278	255	235	219	204	191
	S	48	106	596	397	298	238	198	170	149	132	119	108	99	91	85	79	74
60	T	123	273	1530	1020	765	612	510	437	383	340	306	278	255	235	219	204	191
	S	48	106	596	397	298	238	198	170	149	132	119	108	99	91	85	79	74
80	T	123	273	1530	1020	765	612	510	437	383	340	306	278	255	235	219	204	191
	S	48	106	596	397	298	238	198	170	149	132	119	108	99	91	85	79	74
100	T	123	273	1530	1020	765	612	510	437	383	340	306	278	255	235	219	204	191
	S	48	106	596	397	298	238	198	170	149	132	119	108	99	91	85	79	74
120	T	123	273	1530	1020	765	612	510	437	383	340	306	278	255	235	219	204	191
	S	48	106	596	397	298	238	198	170	149	132	119	108	99	91	85	79	74
140	T	123	273	1530	1020	765	612	510	437	383	340	306	278	255	235	219	204	191
	S	48	106	596	397	298	238	198	170	149	132	119	108	99	91	85	79	74
160	T	123	273	1530	1020	765	612	510	437	383	340	306	278	255	235	219	204	191
	S	48	106	596	397	298	238	198	170	149	132	119	108	99	91	85	79	74
180	T	123	273	1530	1020	765	612	510	437	383	340	306	278	255	235	219	204	191
	S	48	106	596	397	298	238	198	170	149	132	119	108	99	91	85	79	74
200	T	123	273	1530	1020	765	612	510	437	383	340	306	278	255	235	219	204	191
	S	48	106	596	397	298	238	198	170	149	132	119	108	99	91	85	79	74
220	T	123	273	1530	1020	765	612	510	437	383	340	306	278	255	235	219	204	191
	S	48	106	596	397	298	238	198	170	149	132	119	108	99	91	85	79	74
240	T	123	273	1530	1020	765	612	510	437	383	340	306	278	255	235	219	204	191
	S	48	106	596	397	298	238	198	170	149	132	119	108	99	91	85	79	74

Characteristic load-carrying capacity $F_{4/5,Rk}$ (N) for two angle brackets

b / e (mm)		0	20	40	60	80	100	120	140	160	180	200	220	240	260	280	300	320
0	T	14400	14400	14400	14400	14400	14400	14400	14400	14400	14400	14400	14400	14400	14400	14400	14400	14400
	S	-	-	-	-	-	-	-	-	-	-	-	-	-	-	-	-	-
20	T	14400	486	243	162	122	97	81	69	61	54	49	44	41	37	35	32	30
	S	-	201	100	67	50	40	33	28	25	22	20	18	16	15	14	13	12
40	T	14400	973	486	324	243	195	162	139	122	108	97	88	81	75	69	65	61
	S	-	403	201	134	100	80	67	57	50	44	40	36	33	31	28	26	25
60	T	14400	1459	730	486	365	292	243	208	182	162	146	133	122	112	104	97	91
	S	-	604	302	201	151	120	100	86	75	67	60	54	50	46	43	40	37
80	T	14400	1946	973	649	486	389	324	278	243	216	195	177	162	150	139	130	122
	S	-	806	403	268	201	161	134	115	100	89	80	73	67	62	57	53	50
100	T	14400	2432	1216	811	608	486	405	347	304	270	243	221	203	187	174	162	152
	S	-	1007	503	335	251	201	167	143	125	111	100	91	83	77	71	67	62
120	T	14400	2919	1459	973	730	584	486	417	365	324	292	265	243	225	208	195	182
	S	-	1209	604	403	302	241	201	172	151	134	120	109	100	93	86	80	75
140	T	14400	3405	1703	1135	851	681	568	486	426	378	341	310	284	262	243	227	213
	S	-	1411	705	470	352	282	235	201	176	156	141	128	117	108	100	94	88
160	T	14400	3892	1946	1297	973	778	649	556	486	432	389	354	324	299	278	259	243
	S	-	1612	806	537	403	322	268	230	201	179	161	146	134	124	115	107	100
180	T	14400	4378	2189	1459	1095	876	730	625	547	486	438	398	365	337	313	292	274
	S	-	1814	907	604	453	362	302	259	226	201	181	164	151	139	129	120	113
200	T	14400	4865	2432	1622	1216	973	811	695	608	541	486	442	405	374	347	324	304
	S	-	2015	1007	671	503	403	335	287	251	223	201	183	167	155	143	134	125
220	T	14400	5351	2676	1784	1338	1070	892	764	669	595	535	486	446	412	382	357	334
	S	-	2217	1108	739	554	443	369	316	277	246	221	201	184	170	158	147	138
240	T	14400	5838	2919	1946	1459	1168	973	834	730	649	584	531	486	449	417	389	365
	S	-	2418	1209	806	604	483	403	345	302	268	241	219	201	186	172	161	151

TTM: Timber-Timber-Maximum | TTP: Timber-Timber-Partial | TCM: Timber-Concrete-Maximum | TCP: Timber-Concrete-Partial

T: $F_{T,Rk}$ load-carrying capacity of timber | S: $F_{S,Rk}$ load-carrying capacity of steel

Table B. 75 Angle bracket type 6504S, Variant TTM, Fastener GH Nail 4x60, Density 350 kg/m³Characteristic load-carrying capacity $F_{T,Rk}$ (N) for one / two angle brackets

angle bracket		1													2
f (mm)		0	10	20	30	40	50	60	70	80	90	100	110	120	0
$F_{T,Rk}$	T	811	526	375	250	188	150	125	107	94	83	75	68	63	1622
	S	201	130	87	58	43	35	29	25	21	19	17	15	14	402

Characteristic load-carrying capacity $F_{2/3,Rk}$ (N) for one / two angle brackets

angle bracket		1	2
$F_{2/3,Rk}$	T	7950	15900
	S	-	-

Characteristic load-carrying capacity $F_{4,Rk}$ (N) for one angle bracket

e (mm)		0	20	40	60	80	100	120	140	160	180	200	220	240	260	280	300	320
$F_{4,Rk}$	T	28367	750	375	250	172	118	90	72	61	52	46	41	37	34	31	28	26
	S	-	186	93	62	40	27	21	16	14	12	10	9	8	7	7	6	6

Characteristic load-carrying capacity $F_{5,Rk}$ (N) for one angle bracket

b / e (mm)		0	20	40	60	80	100	120	140	160	180	200	220	240	260	280	300	320
0	T	205	455	2400	1600	1200	960	800	686	600	533	480	436	400	369	343	320	300
	S	48	106	596	397	298	238	198	170	149	132	119	108	99	91	85	79	74
20	T	205	455	2550	1700	1275	1020	850	729	638	567	510	464	425	392	364	340	319
	S	48	106	596	397	298	238	198	170	149	132	119	108	99	91	85	79	74
40	T	205	455	2550	1700	1275	1020	850	729	638	567	510	464	425	392	364	340	319
	S	48	106	596	397	298	238	198	170	149	132	119	108	99	91	85	79	74
60	T	205	455	2550	1700	1275	1020	850	729	638	567	510	464	425	392	364	340	319
	S	48	106	596	397	298	238	198	170	149	132	119	108	99	91	85	79	74
80	T	205	455	2550	1700	1275	1020	850	729	638	567	510	464	425	392	364	340	319
	S	48	106	596	397	298	238	198	170	149	132	119	108	99	91	85	79	74
100	T	205	455	2550	1700	1275	1020	850	729	638	567	510	464	425	392	364	340	319
	S	48	106	596	397	298	238	198	170	149	132	119	108	99	91	85	79	74
120	T	205	455	2550	1700	1275	1020	850	729	638	567	510	464	425	392	364	340	319
	S	48	106	596	397	298	238	198	170	149	132	119	108	99	91	85	79	74
140	T	205	455	2550	1700	1275	1020	850	729	638	567	510	464	425	392	364	340	319
	S	48	106	596	397	298	238	198	170	149	132	119	108	99	91	85	79	74
160	T	205	455	2550	1700	1275	1020	850	729	638	567	510	464	425	392	364	340	319
	S	48	106	596	397	298	238	198	170	149	132	119	108	99	91	85	79	74
180	T	205	455	2550	1700	1275	1020	850	729	638	567	510	464	425	392	364	340	319
	S	48	106	596	397	298	238	198	170	149	132	119	108	99	91	85	79	74
200	T	205	455	2550	1700	1275	1020	850	729	638	567	510	464	425	392	364	340	319
	S	48	106	596	397	298	238	198	170	149	132	119	108	99	91	85	79	74
220	T	205	455	2550	1700	1275	1020	850	729	638	567	510	464	425	392	364	340	319
	S	48	106	596	397	298	238	198	170	149	132	119	108	99	91	85	79	74
240	T	205	455	2550	1700	1275	1020	850	729	638	567	510	464	425	392	364	340	319
	S	48	106	596	397	298	238	198	170	149	132	119	108	99	91	85	79	74

Characteristic load-carrying capacity $F_{4/5,Rk}$ (N) for two angle brackets

b / e (mm)		0	20	40	60	80	100	120	140	160	180	200	220	240	260	280	300	320
0	T	23999	23999	23999	23999	23999	23999	23999	23999	23999	23999	23999	23999	23999	23999	23999	23999	23999
	S	-	-	-	-	-	-	-	-	-	-	-	-	-	-	-	-	-
20	T	23999	811	405	270	203	162	135	116	101	90	81	74	68	62	58	54	51
	S	-	201	100	67	50	40	33	28	25	22	20	18	16	15	14	13	12
40	T	23999	1622	811	541	405	324	270	232	203	180	162	147	135	125	116	108	101
	S	-	403	201	134	100	80	67	57	50	44	40	36	33	31	28	26	25
60	T	23999	2432	1216	811	608	486	405	347	304	270	243	221	203	187	174	162	152
	S	-	604	302	201	151	120	100	86	75	67	60	54	50	46	43	40	37
80	T	23999	3243	1622	1081	811	649	541	463	405	360	324	295	270	249	232	216	203
	S	-	806	403	268	201	161	134	115	100	89	80	73	67	62	57	53	50
100	T	23999	4054	2027	1351	1014	811	676	579	507	450	405	369	338	312	290	270	253
	S	-	1007	503	335	251	201	167	143	125	111	100	91	83	77	71	67	62
120	T	23999	4865	2432	1622	1216	973	811	695	608	541	486	442	405	374	347	324	304
	S	-	1209	604	403	302	241	201	172	151	134	120	109	100	93	86	80	75
140	T	23999	5676	2838	1892	1419	1135	946	811	709	631	568	516	473	437	405	378	355
	S	-	1411	705	470	352	282	235	201	176	156	141	128	117	108	100	94	88
160	T	23999	6486	3243	2162	1622	1297	1081	927	811	721	649	590	541	499	463	432	405
	S	-	1612	806	537	403	322	268	230	201	179	161	146	134	124	115	107	100
180	T	23999	7297	3649	2432	1824	1459	1216	1042	912	811	730	663	608	561	521	486	456
	S	-	1814	907	604	453	362	302	259	226	201	181	164	151	139	129	120	113
200	T	23999	8108	4054	2703	2027	1622	1351	1158	1014	901	811	737	676	624	579	541	507
	S	-	2015	1007	671	503	403	335	287	251	223	201	183	167	155	143	134	125
220	T	23999	8919	4459	2973	2230	1784	1486	1274	1115	991	892	811	743	686	637	595	557
	S	-	2217	1108	739	554	443	369	316	277	246	221	201	184	170	158	147	138
240	T	23999	9730	4865	3243	2432	1946	1622	1390	1216	1081	973	885	811	748	695	649	608
	S	-	2418	1209	806	604	483	403	345	302	268	241	219	201	186	172	161	151

TTM: Timber-Timber-Maximum | TTP: Timber-Timber-Partial | TCM: Timber-Concrete-Maximum | TCP: Timber-Concrete-Partial

T: $F_{T,Rk}$ load-carrying capacity of timber | S: $F_{S,Rk}$ load-carrying capacity of steel

Table B. 76 Angle bracket type 6504S, Variant TTM, Fastener GH Screw 5x40, Density 350 kg/m³Characteristic load-carrying capacity $F_{T,Rk}$ (N) for one / two angle brackets

angle bracket		1													2
f (mm)		0	10	20	30	40	50	60	70	80	90	100	110	120	0
$F_{T,Rk}$	T	1022	663	473	315	236	189	158	135	118	105	95	86	79	2043
	S	201	130	87	58	43	35	29	25	21	19	17	15	14	402

Characteristic load-carrying capacity $F_{2/3,Rk}$ (N) for one / two angle brackets

angle bracket		1	2
$F_{2/3,Rk}$	T	7250	14500
	S	-	-

Characteristic load-carrying capacity $F_{4,Rk}$ (N) for one angle bracket

e (mm)		0	20	40	60	80	100	120	140	160	180	200	220	240	260	280	300	320
$F_{4,Rk}$	T	24035	945	473	315	217	149	113	91	77	66	58	51	46	42	39	36	33
	S	-	186	93	62	40	27	21	16	14	12	10	9	8	7	7	6	6

Characteristic load-carrying capacity $F_{5,Rk}$ (N) for one angle bracket

b / e (mm)		0	20	40	60	80	100	120	140	160	180	200	220	240	260	280	300	320
0	T	259	573	3024	2016	1512	1210	1008	864	756	672	605	550	504	465	432	403	378
	S	48	106	596	397	298	238	198	170	149	132	119	108	99	91	85	79	74
20	T	259	573	3213	2142	1607	1285	1071	918	803	714	643	584	536	494	459	428	402
	S	48	106	596	397	298	238	198	170	149	132	119	108	99	91	85	79	74
40	T	259	573	3213	2142	1607	1285	1071	918	803	714	643	584	536	494	459	428	402
	S	48	106	596	397	298	238	198	170	149	132	119	108	99	91	85	79	74
60	T	259	573	3213	2142	1607	1285	1071	918	803	714	643	584	536	494	459	428	402
	S	48	106	596	397	298	238	198	170	149	132	119	108	99	91	85	79	74
80	T	259	573	3213	2142	1607	1285	1071	918	803	714	643	584	536	494	459	428	402
	S	48	106	596	397	298	238	198	170	149	132	119	108	99	91	85	79	74
100	T	259	573	3213	2142	1607	1285	1071	918	803	714	643	584	536	494	459	428	402
	S	48	106	596	397	298	238	198	170	149	132	119	108	99	91	85	79	74
120	T	259	573	3213	2142	1607	1285	1071	918	803	714	643	584	536	494	459	428	402
	S	48	106	596	397	298	238	198	170	149	132	119	108	99	91	85	79	74
140	T	259	573	3213	2142	1607	1285	1071	918	803	714	643	584	536	494	459	428	402
	S	48	106	596	397	298	238	198	170	149	132	119	108	99	91	85	79	74
160	T	259	573	3213	2142	1607	1285	1071	918	803	714	643	584	536	494	459	428	402
	S	48	106	596	397	298	238	198	170	149	132	119	108	99	91	85	79	74
180	T	259	573	3213	2142	1607	1285	1071	918	803	714	643	584	536	494	459	428	402
	S	48	106	596	397	298	238	198	170	149	132	119	108	99	91	85	79	74
200	T	259	573	3213	2142	1607	1285	1071	918	803	714	643	584	536	494	459	428	402
	S	48	106	596	397	298	238	198	170	149	132	119	108	99	91	85	79	74
220	T	259	573	3213	2142	1607	1285	1071	918	803	714	643	584	536	494	459	428	402
	S	48	106	596	397	298	238	198	170	149	132	119	108	99	91	85	79	74
240	T	259	573	3213	2142	1607	1285	1071	918	803	714	643	584	536	494	459	428	402
	S	48	106	596	397	298	238	198	170	149	132	119	108	99	91	85	79	74

Characteristic load-carrying capacity $F_{4/5,Rk}$ (N) for two angle brackets

b / e (mm)		0	20	40	60	80	100	120	140	160	180	200	220	240	260	280	300	320
0	T	30239	30239	30239	30239	30239	30239	30239	30239	30239	30239	30239	30239	30239	30239	30239	30239	30239
	S	-	-	-	-	-	-	-	-	-	-	-	-	-	-	-	-	-
20	T	30239	1022	511	341	255	204	170	146	128	114	102	93	85	79	73	68	64
	S	-	201	100	67	50	40	33	28	25	22	20	18	16	15	14	13	12
40	T	30239	2043	1022	681	511	409	341	292	255	227	204	186	170	157	146	136	128
	S	-	403	201	134	100	80	67	57	50	44	40	36	33	31	28	26	25
60	T	30239	3065	1532	1022	766	613	511	438	383	341	306	279	255	236	219	204	192
	S	-	604	302	201	151	120	100	86	75	67	60	54	50	46	43	40	37
80	T	30239	4086	2043	1362	1022	817	681	584	511	454	409	371	341	314	292	272	255
	S	-	806	403	268	201	161	134	115	100	89	80	73	67	62	57	53	50
100	T	30239	5108	2554	1703	1277	1022	851	730	639	568	511	464	426	393	365	341	319
	S	-	1007	503	335	251	201	167	143	125	111	100	91	83	77	71	67	62
120	T	30239	6130	3065	2043	1532	1226	1022	876	766	681	613	557	511	472	438	409	383
	S	-	1209	604	403	302	241	201	172	151	134	120	109	100	93	86	80	75
140	T	30239	7151	3576	2384	1788	1430	1192	1022	894	795	715	650	596	550	511	477	447
	S	-	1411	705	470	352	282	235	201	176	156	141	128	117	108	100	94	88
160	T	30239	8173	4086	2724	2043	1635	1362	1168	1022	908	817	743	681	629	584	545	511
	S	-	1612	806	537	403	322	268	230	201	179	161	146	134	124	115	107	100
180	T	30239	9195	4597	3065	2299	1839	1532	1314	1149	1022	919	836	766	707	657	613	575
	S	-	1814	907	604	453	362	302	259	226	201	181	164	151	139	129	120	113
200	T	30239	10216	5108	3405	2554	2043	1703	1459	1277	1135	1022	929	851	786	730	681	639
	S	-	2015	1007	671	503	403	335	287	251	223	201	183	167	155	143	134	125
220	T	30239	11238	5619	3746	2809	2248	1873	1605	1405	1249	1124	1022	936	864	803	749	702
	S	-	2217	1108	739	554	443	369	316	277	246	221	201	184	170	158	147	138
240	T	30239	12259	6130	4086	3065	2452	2043	1751	1532	1362	1226	1114	1022	943	876	817	766
	S	-	2418	1209	806	604	483	403	345	302	268	241	219	201	186	172	161	151

TTM: Timber-Timber-Maximum | TTP: Timber-Timber-Partial | TCM: Timber-Concrete-Maximum | TCP: Timber-Concrete-Partial

T: $F_{T,Rk}$ load-carrying capacity of timber | S: $F_{S,Rk}$ load-carrying capacity of steel

Table B. 77 Angle bracket type 6504S, Variant TTM, Fastener GH Screw 5x60, Density 350 kg/m³Characteristic load-carrying capacity $F_{1,Rk}$ (N) for one / two angle brackets

angle bracket		1													2
f (mm)		0	10	20	30	40	50	60	70	80	90	100	110	120	0
$F_{1,Rk}$	T	1589	1032	735	490	368	294	245	210	184	163	147	134	123	3178
	S	201	130	87	58	43	35	29	25	21	19	17	15	14	402

Characteristic load-carrying capacity $F_{2/3,Rk}$ (N) for one / two angle brackets

angle bracket		1	2
$F_{2/3,Rk}$	T	8580	17160
	S	-	-

Characteristic load-carrying capacity $F_{4,Rk}$ (N) for one angle bracket

e (mm)		0	20	40	60	80	100	120	140	160	180	200	220	240	260	280	300	320
$F_{4,Rk}$	T	27179	1470	735	490	338	231	176	142	119	102	90	80	72	66	60	56	52
	S	-	186	93	62	40	27	21	16	14	12	10	9	8	7	7	6	6

Characteristic load-carrying capacity $F_{5,Rk}$ (N) for one angle bracket

b / e (mm)		0	20	40	60	80	100	120	140	160	180	200	220	240	260	280	300	320
0	T	403	891	4704	3136	2352	1882	1568	1344	1176	1045	941	855	784	724	672	627	588
	S	48	106	596	397	298	238	198	170	149	132	119	108	99	91	85	79	74
20	T	403	891	4998	3332	2499	1999	1666	1428	1250	1111	1000	909	833	769	714	666	625
	S	48	106	596	397	298	238	198	170	149	132	119	108	99	91	85	79	74
40	T	403	891	4998	3332	2499	1999	1666	1428	1250	1111	1000	909	833	769	714	666	625
	S	48	106	596	397	298	238	198	170	149	132	119	108	99	91	85	79	74
60	T	403	891	4998	3332	2499	1999	1666	1428	1250	1111	1000	909	833	769	714	666	625
	S	48	106	596	397	298	238	198	170	149	132	119	108	99	91	85	79	74
80	T	403	891	4998	3332	2499	1999	1666	1428	1250	1111	1000	909	833	769	714	666	625
	S	48	106	596	397	298	238	198	170	149	132	119	108	99	91	85	79	74
100	T	403	891	4998	3332	2499	1999	1666	1428	1250	1111	1000	909	833	769	714	666	625
	S	48	106	596	397	298	238	198	170	149	132	119	108	99	91	85	79	74
120	T	403	891	4998	3332	2499	1999	1666	1428	1250	1111	1000	909	833	769	714	666	625
	S	48	106	596	397	298	238	198	170	149	132	119	108	99	91	85	79	74
140	T	403	891	4998	3332	2499	1999	1666	1428	1250	1111	1000	909	833	769	714	666	625
	S	48	106	596	397	298	238	198	170	149	132	119	108	99	91	85	79	74
160	T	403	891	4998	3332	2499	1999	1666	1428	1250	1111	1000	909	833	769	714	666	625
	S	48	106	596	397	298	238	198	170	149	132	119	108	99	91	85	79	74
180	T	403	891	4998	3332	2499	1999	1666	1428	1250	1111	1000	909	833	769	714	666	625
	S	48	106	596	397	298	238	198	170	149	132	119	108	99	91	85	79	74
200	T	403	891	4998	3332	2499	1999	1666	1428	1250	1111	1000	909	833	769	714	666	625
	S	48	106	596	397	298	238	198	170	149	132	119	108	99	91	85	79	74
220	T	403	891	4998	3332	2499	1999	1666	1428	1250	1111	1000	909	833	769	714	666	625
	S	48	106	596	397	298	238	198	170	149	132	119	108	99	91	85	79	74
240	T	403	891	4998	3332	2499	1999	1666	1428	1250	1111	1000	909	833	769	714	666	625
	S	48	106	596	397	298	238	198	170	149	132	119	108	99	91	85	79	74

Characteristic load-carrying capacity $F_{4/5,Rk}$ (N) for two angle brackets

b / e (mm)		0	20	40	60	80	100	120	140	160	180	200	220	240	260	280	300	320
0	T	47040	47040	47040	47040	47040	47040	47040	47040	47040	47040	47040	47040	47040	47040	47040	47040	47040
	S	-	-	-	-	-	-	-	-	-	-	-	-	-	-	-	-	-
20	T	47040	1589	795	530	397	318	265	227	199	177	159	144	132	122	114	106	99
	S	-	201	100	67	50	40	33	28	25	22	20	18	16	15	14	13	12
40	T	47040	3178	1589	1059	795	636	530	454	397	353	318	289	265	244	227	212	199
	S	-	403	201	134	100	80	67	57	50	44	40	36	33	31	28	26	25
60	T	47040	4768	2384	1589	1192	954	795	681	596	530	477	433	397	367	341	318	298
	S	-	604	302	201	151	120	100	86	75	67	60	54	50	46	43	40	37
80	T	47040	6357	3178	2119	1589	1271	1059	908	795	706	636	578	530	489	454	424	397
	S	-	806	403	268	201	161	134	115	100	89	80	73	67	62	57	53	50
100	T	47040	7946	3973	2649	1986	1589	1324	1135	993	883	795	722	662	611	568	530	497
	S	-	1007	503	335	251	201	167	143	125	111	100	91	83	77	71	67	62
120	T	47040	9535	4768	3178	2384	1907	1589	1362	1192	1059	954	867	795	733	681	636	596
	S	-	1209	604	403	302	241	201	172	151	134	120	109	100	93	86	80	75
140	T	47040	11124	5562	3708	2781	2225	1854	1589	1391	1236	1112	1011	927	856	795	742	695
	S	-	1411	705	470	352	282	235	201	176	156	141	128	117	108	100	94	88
160	T	47040	12714	6357	4238	3178	2543	2119	1816	1589	1413	1271	1156	1059	978	908	848	795
	S	-	1612	806	537	403	322	268	230	201	179	161	146	134	124	115	107	100
180	T	47040	14303	7151	4768	3576	2861	2384	2043	1788	1589	1430	1300	1192	1100	1022	954	894
	S	-	1814	907	604	453	362	302	259	226	201	181	164	151	139	129	120	113
200	T	47040	15892	7946	5297	3973	3178	2649	2270	1986	1766	1589	1445	1324	1222	1135	1059	993
	S	-	2015	1007	671	503	403	335	287	251	223	201	183	167	155	143	134	125
220	T	47040	17481	8741	5827	4370	3496	2914	2497	2185	1942	1748	1589	1457	1345	1249	1165	1093
	S	-	2217	1108	739	554	443	369	316	277	246	221	201	184	170	158	147	138
240	T	47040	19070	9535	6357	4768	3814	3178	2724	2384	2119	1907	1734	1589	1467	1362	1271	1192
	S	-	2418	1209	806	604	483	403	345	302	268	241	219	201	186	172	161	151

TTM: Timber-Timber-Maximum | TTP: Timber-Timber-Partial | TCM: Timber-Concrete-Maximum | TCP: Timber-Concrete-Partial

T: $F_{1,T,Rk}$ load-carrying capacity of timber | S: $F_{1,S,Rk}$ load-carrying capacity of steel

Table B. 78 Angle bracket type 6504S, Variant TTP, Fastener GH Nail 4x40, Density 350 kg/m³Characteristic load-carrying capacity $F_{T,Rk}$ (N) for one / two angle brackets

angle bracket		1													2
f (mm)		0	10	20	30	40	50	60	70	80	90	100	110	120	0
$F_{T,Rk}$	T	486	316	225	150	113	90	75	64	56	50	45	41	38	973
	S	201	130	87	58	43	35	29	25	21	19	17	15	14	402

Characteristic load-carrying capacity $F_{2/3,Rk}$ (N) for one / two angle brackets

angle bracket		1	2
$F_{2/3,Rk}$	T	3580	7160
	S	-	-

Characteristic load-carrying capacity $F_{4,Rk}$ (N) for one angle bracket

e (mm)		0	20	40	60	80	100	120	140	160	180	200	220	240	260	280	300	320
$F_{4,Rk}$	T	11340	450	225	150	103	71	54	43	36	31	28	25	22	20	18	17	16
	S	-	186	93	62	40	27	21	16	14	12	10	9	8	7	7	6	6

Characteristic load-carrying capacity $F_{5,Rk}$ (N) for one angle bracket

b / e (mm)		0	20	40	60	80	100	120	140	160	180	200	220	240	260	280	300	320
0	T	123	273	1440	960	720	576	480	411	360	320	288	262	240	222	206	192	180
	S	48	106	596	397	298	238	198	170	149	132	119	108	99	91	85	79	74
20	T	123	273	1530	1020	765	612	510	437	383	340	306	278	255	235	219	204	191
	S	48	106	596	397	298	238	198	170	149	132	119	108	99	91	85	79	74
40	T	123	273	1530	1020	765	612	510	437	383	340	306	278	255	235	219	204	191
	S	48	106	596	397	298	238	198	170	149	132	119	108	99	91	85	79	74
60	T	123	273	1530	1020	765	612	510	437	383	340	306	278	255	235	219	204	191
	S	48	106	596	397	298	238	198	170	149	132	119	108	99	91	85	79	74
80	T	123	273	1530	1020	765	612	510	437	383	340	306	278	255	235	219	204	191
	S	48	106	596	397	298	238	198	170	149	132	119	108	99	91	85	79	74
100	T	123	273	1530	1020	765	612	510	437	383	340	306	278	255	235	219	204	191
	S	48	106	596	397	298	238	198	170	149	132	119	108	99	91	85	79	74
120	T	123	273	1530	1020	765	612	510	437	383	340	306	278	255	235	219	204	191
	S	48	106	596	397	298	238	198	170	149	132	119	108	99	91	85	79	74
140	T	123	273	1530	1020	765	612	510	437	383	340	306	278	255	235	219	204	191
	S	48	106	596	397	298	238	198	170	149	132	119	108	99	91	85	79	74
160	T	123	273	1530	1020	765	612	510	437	383	340	306	278	255	235	219	204	191
	S	48	106	596	397	298	238	198	170	149	132	119	108	99	91	85	79	74
180	T	123	273	1530	1020	765	612	510	437	383	340	306	278	255	235	219	204	191
	S	48	106	596	397	298	238	198	170	149	132	119	108	99	91	85	79	74
200	T	123	273	1530	1020	765	612	510	437	383	340	306	278	255	235	219	204	191
	S	48	106	596	397	298	238	198	170	149	132	119	108	99	91	85	79	74
220	T	123	273	1530	1020	765	612	510	437	383	340	306	278	255	235	219	204	191
	S	48	106	596	397	298	238	198	170	149	132	119	108	99	91	85	79	74
240	T	123	273	1530	1020	765	612	510	437	383	340	306	278	255	235	219	204	191
	S	48	106	596	397	298	238	198	170	149	132	119	108	99	91	85	79	74

Characteristic load-carrying capacity $F_{4/5,Rk}$ (N) for two angle brackets

b / e (mm)		0	20	40	60	80	100	120	140	160	180	200	220	240	260	280	300	320
0	T	7199	7199	7199	7199	7199	7199	7199	7199	7199	7199	7199	7199	7199	7199	7199	7199	7199
	S	-	-	-	-	-	-	-	-	-	-	-	-	-	-	-	-	-
20	T	7199	486	243	162	122	97	81	69	61	54	49	44	41	37	35	32	30
	S	-	201	100	67	50	40	33	28	25	22	20	18	16	15	14	13	12
40	T	7199	973	486	324	243	195	162	139	122	108	97	88	81	75	69	65	61
	S	-	403	201	134	100	80	67	57	50	44	40	36	33	31	28	26	25
60	T	7199	1459	730	486	365	292	243	208	182	162	146	133	122	112	104	97	91
	S	-	604	302	201	151	120	100	86	75	67	60	54	50	46	43	40	37
80	T	7199	1946	973	649	486	389	324	278	243	216	195	177	162	150	139	130	122
	S	-	806	403	268	201	161	134	115	100	89	80	73	67	62	57	53	50
100	T	7199	2432	1216	811	608	486	405	347	304	270	243	221	203	187	174	162	152
	S	-	1007	503	335	251	201	167	143	125	111	100	91	83	77	71	67	62
120	T	7199	2919	1459	973	730	584	486	417	365	324	292	265	243	225	208	195	182
	S	-	1209	604	403	302	241	201	172	151	134	120	109	100	93	86	80	75
140	T	7199	3405	1703	1135	851	681	568	486	426	378	341	310	284	262	243	227	213
	S	-	1411	705	470	352	282	235	201	176	156	141	128	117	108	100	94	88
160	T	7199	3892	1946	1297	973	778	649	556	486	432	389	354	324	299	278	259	243
	S	-	1612	806	537	403	322	268	230	201	179	161	146	134	124	115	107	100
180	T	7199	4378	2189	1459	1095	876	730	625	547	486	438	398	365	337	313	292	274
	S	-	1814	907	604	453	362	302	259	226	201	181	164	151	139	129	120	113
200	T	7199	4865	2432	1622	1216	973	811	695	608	541	486	442	405	374	347	324	304
	S	-	2015	1007	671	503	403	335	287	251	223	201	183	167	155	143	134	125
220	T	7199	5351	2676	1784	1338	1070	892	764	669	595	535	486	446	412	382	357	334
	S	-	2217	1108	739	554	443	369	316	277	246	221	201	184	170	158	147	138
240	T	7199	5838	2919	1946	1459	1168	973	834	730	649	584	531	486	449	417	389	365
	S	-	2418	1209	806	604	483	403	345	302	268	241	219	201	186	172	161	151

TTM: Timber-Timber-Maximum | TTP: Timber-Timber-Partial | TCM: Timber-Concrete-Maximum | TCP: Timber-Concrete-Partial

T: $F_{T,Rk}$ load-carrying capacity of timber | S: $F_{S,Rk}$ load-carrying capacity of steel

Table B. 79 Angle bracket type 6504S, Variant TTP, Fastener GH Nail 4x60, Density 350 kg/m³Characteristic load-carrying capacity $F_{T,Rk}$ (N) for one / two angle brackets

angle bracket		1													2
f (mm)		0	10	20	30	40	50	60	70	80	90	100	110	120	0
$F_{T,Rk}$	T	811	526	375	250	188	150	125	107	94	83	75	68	63	1622
	S	201	130	87	58	43	35	29	25	21	19	17	15	14	402

Characteristic load-carrying capacity $F_{2/3,Rk}$ (N) for one / two angle brackets

angle bracket		1	2
$F_{2/3,Rk}$	T	4750	9500
	S	-	-

Characteristic load-carrying capacity $F_{4,Rk}$ (N) for one angle bracket

e (mm)		0	20	40	60	80	100	120	140	160	180	200	220	240	260	280	300	320
$F_{4,Rk}$	T	14184	750	375	250	172	118	90	72	61	52	46	41	37	34	31	28	26
	S	-	186	93	62	40	27	21	16	14	12	10	9	8	7	7	6	6

Characteristic load-carrying capacity $F_{5,Rk}$ (N) for one angle bracket

b / e (mm)		0	20	40	60	80	100	120	140	160	180	200	220	240	260	280	300	320
0	T	205	455	2400	1600	1200	960	800	686	600	533	480	436	400	369	343	320	300
	S	48	106	596	397	298	238	198	170	149	132	119	108	99	91	85	79	74
20	T	205	455	2550	1700	1275	1020	850	729	638	567	510	464	425	392	364	340	319
	S	48	106	596	397	298	238	198	170	149	132	119	108	99	91	85	79	74
40	T	205	455	2550	1700	1275	1020	850	729	638	567	510	464	425	392	364	340	319
	S	48	106	596	397	298	238	198	170	149	132	119	108	99	91	85	79	74
60	T	205	455	2550	1700	1275	1020	850	729	638	567	510	464	425	392	364	340	319
	S	48	106	596	397	298	238	198	170	149	132	119	108	99	91	85	79	74
80	T	205	455	2550	1700	1275	1020	850	729	638	567	510	464	425	392	364	340	319
	S	48	106	596	397	298	238	198	170	149	132	119	108	99	91	85	79	74
100	T	205	455	2550	1700	1275	1020	850	729	638	567	510	464	425	392	364	340	319
	S	48	106	596	397	298	238	198	170	149	132	119	108	99	91	85	79	74
120	T	205	455	2550	1700	1275	1020	850	729	638	567	510	464	425	392	364	340	319
	S	48	106	596	397	298	238	198	170	149	132	119	108	99	91	85	79	74
140	T	205	455	2550	1700	1275	1020	850	729	638	567	510	464	425	392	364	340	319
	S	48	106	596	397	298	238	198	170	149	132	119	108	99	91	85	79	74
160	T	205	455	2550	1700	1275	1020	850	729	638	567	510	464	425	392	364	340	319
	S	48	106	596	397	298	238	198	170	149	132	119	108	99	91	85	79	74
180	T	205	455	2550	1700	1275	1020	850	729	638	567	510	464	425	392	364	340	319
	S	48	106	596	397	298	238	198	170	149	132	119	108	99	91	85	79	74
200	T	205	455	2550	1700	1275	1020	850	729	638	567	510	464	425	392	364	340	319
	S	48	106	596	397	298	238	198	170	149	132	119	108	99	91	85	79	74
220	T	205	455	2550	1700	1275	1020	850	729	638	567	510	464	425	392	364	340	319
	S	48	106	596	397	298	238	198	170	149	132	119	108	99	91	85	79	74
240	T	205	455	2550	1700	1275	1020	850	729	638	567	510	464	425	392	364	340	319
	S	48	106	596	397	298	238	198	170	149	132	119	108	99	91	85	79	74

Characteristic load-carrying capacity $F_{4/5,Rk}$ (N) for two angle brackets

b / e (mm)		0	20	40	60	80	100	120	140	160	180	200	220	240	260	280	300	320
0	T	12000	12000	12000	12000	12000	12000	12000	12000	12000	12000	12000	12000	12000	12000	12000	12000	12000
	S	-	-	-	-	-	-	-	-	-	-	-	-	-	-	-	-	-
20	T	12000	811	405	270	203	162	135	116	101	90	81	74	68	62	58	54	51
	S	-	201	100	67	50	40	33	28	25	22	20	18	16	15	14	13	12
40	T	12000	1622	811	541	405	324	270	232	203	180	162	147	135	125	116	108	101
	S	-	403	201	134	100	80	67	57	50	44	40	36	33	31	28	26	25
60	T	12000	2432	1216	811	608	486	405	347	304	270	243	221	203	187	174	162	152
	S	-	604	302	201	151	120	100	86	75	67	60	54	50	46	43	40	37
80	T	12000	3243	1622	1081	811	649	541	463	405	360	324	295	270	249	232	216	203
	S	-	806	403	268	201	161	134	115	100	89	80	73	67	62	57	53	50
100	T	12000	4054	2027	1351	1014	811	676	579	507	450	405	369	338	312	290	270	253
	S	-	1007	503	335	251	201	167	143	125	111	100	91	83	77	71	67	62
120	T	12000	4865	2432	1622	1216	973	811	695	608	541	486	442	405	374	347	324	304
	S	-	1209	604	403	302	241	201	172	151	134	120	109	100	93	86	80	75
140	T	12000	5676	2838	1892	1419	1135	946	811	709	631	568	516	473	437	405	378	355
	S	-	1411	705	470	352	282	235	201	176	156	141	128	117	108	100	94	88
160	T	12000	6486	3243	2162	1622	1297	1081	927	811	721	649	590	541	499	463	432	405
	S	-	1612	806	537	403	322	268	230	201	179	161	146	134	124	115	107	100
180	T	12000	7297	3649	2432	1824	1459	1216	1042	912	811	730	663	608	561	521	486	456
	S	-	1814	907	604	453	362	302	259	226	201	181	164	151	139	129	120	113
200	T	12000	8108	4054	2703	2027	1622	1351	1158	1014	901	811	737	676	624	579	541	507
	S	-	2015	1007	671	503	403	335	287	251	223	201	183	167	155	143	134	125
220	T	12000	8919	4459	2973	2230	1784	1486	1274	1115	991	892	811	743	686	637	595	557
	S	-	2217	1108	739	554	443	369	316	277	246	221	201	184	170	158	147	138
240	T	12000	9730	4865	3243	2432	1946	1622	1390	1216	1081	973	885	811	748	695	649	608
	S	-	2418	1209	806	604	483	403	345	302	268	241	219	201	186	172	161	151

TTM: Timber-Timber-Maximum | TTP: Timber-Timber-Partial | TCM: Timber-Concrete-Maximum | TCP: Timber-Concrete-Partial

T: $F_{T,Rk}$ load-carrying capacity of timber | S: $F_{S,Rk}$ load-carrying capacity of steel

Table B. 80 Angle bracket type 6504S, Variant TTP, Fastener GH Screw 5x40, Density 350 kg/m³Characteristic load-carrying capacity $F_{T,Rk}$ (N) for one / two angle brackets

angle bracket		1													2
f (mm)		0	10	20	30	40	50	60	70	80	90	100	110	120	0
$F_{T,Rk}$	T	1022	663	473	315	236	189	158	135	118	105	95	86	79	2043
	S	201	130	87	58	43	35	29	25	21	19	17	15	14	402

Characteristic load-carrying capacity $F_{2/3,Rk}$ (N) for one / two angle brackets

angle bracket		1	2
$F_{2/3,Rk}$	T	4360	8720
	S	-	-

Characteristic load-carrying capacity $F_{4,Rk}$ (N) for one angle bracket

e (mm)		0	20	40	60	80	100	120	140	160	180	200	220	240	260	280	300	320
$F_{4,Rk}$	T	12018	945	473	315	217	149	113	91	77	66	58	51	46	42	39	36	33
	S	-	186	93	62	40	27	21	16	14	12	10	9	8	7	7	6	6

Characteristic load-carrying capacity $F_{5,Rk}$ (N) for one angle bracket

b / e (mm)		0	20	40	60	80	100	120	140	160	180	200	220	240	260	280	300	320
0	T	259	573	3024	2016	1512	1210	1008	864	756	672	605	550	504	465	432	403	378
	S	48	106	596	397	298	238	198	170	149	132	119	108	99	91	85	79	74
20	T	259	573	3213	2142	1607	1285	1071	918	803	714	643	584	536	494	459	428	402
	S	48	106	596	397	298	238	198	170	149	132	119	108	99	91	85	79	74
40	T	259	573	3213	2142	1607	1285	1071	918	803	714	643	584	536	494	459	428	402
	S	48	106	596	397	298	238	198	170	149	132	119	108	99	91	85	79	74
60	T	259	573	3213	2142	1607	1285	1071	918	803	714	643	584	536	494	459	428	402
	S	48	106	596	397	298	238	198	170	149	132	119	108	99	91	85	79	74
80	T	259	573	3213	2142	1607	1285	1071	918	803	714	643	584	536	494	459	428	402
	S	48	106	596	397	298	238	198	170	149	132	119	108	99	91	85	79	74
100	T	259	573	3213	2142	1607	1285	1071	918	803	714	643	584	536	494	459	428	402
	S	48	106	596	397	298	238	198	170	149	132	119	108	99	91	85	79	74
120	T	259	573	3213	2142	1607	1285	1071	918	803	714	643	584	536	494	459	428	402
	S	48	106	596	397	298	238	198	170	149	132	119	108	99	91	85	79	74
140	T	259	573	3213	2142	1607	1285	1071	918	803	714	643	584	536	494	459	428	402
	S	48	106	596	397	298	238	198	170	149	132	119	108	99	91	85	79	74
160	T	259	573	3213	2142	1607	1285	1071	918	803	714	643	584	536	494	459	428	402
	S	48	106	596	397	298	238	198	170	149	132	119	108	99	91	85	79	74
180	T	259	573	3213	2142	1607	1285	1071	918	803	714	643	584	536	494	459	428	402
	S	48	106	596	397	298	238	198	170	149	132	119	108	99	91	85	79	74
200	T	259	573	3213	2142	1607	1285	1071	918	803	714	643	584	536	494	459	428	402
	S	48	106	596	397	298	238	198	170	149	132	119	108	99	91	85	79	74
220	T	259	573	3213	2142	1607	1285	1071	918	803	714	643	584	536	494	459	428	402
	S	48	106	596	397	298	238	198	170	149	132	119	108	99	91	85	79	74
240	T	259	573	3213	2142	1607	1285	1071	918	803	714	643	584	536	494	459	428	402
	S	48	106	596	397	298	238	198	170	149	132	119	108	99	91	85	79	74

Characteristic load-carrying capacity $F_{4/5,Rk}$ (N) for two angle brackets

b / e (mm)		0	20	40	60	80	100	120	140	160	180	200	220	240	260	280	300	320
0	T	15120	15120	15120	15120	15120	15120	15120	15120	15120	15120	15120	15120	15120	15120	15120	15120	15120
	S	-	-	-	-	-	-	-	-	-	-	-	-	-	-	-	-	-
20	T	15120	1022	511	341	255	204	170	146	128	114	102	93	85	79	73	68	64
	S	-	201	100	67	50	40	33	28	25	22	20	18	16	15	14	13	12
40	T	15120	2043	1022	681	511	409	341	292	255	227	204	186	170	157	146	136	128
	S	-	403	201	134	100	80	67	57	50	44	40	36	33	31	28	26	25
60	T	15120	3065	1532	1022	766	613	511	438	383	341	306	279	255	236	219	204	192
	S	-	604	302	201	151	120	100	86	75	67	60	54	50	46	43	40	37
80	T	15120	4086	2043	1362	1022	817	681	584	511	454	409	371	341	314	292	272	255
	S	-	806	403	268	201	161	134	115	100	89	80	73	67	62	57	53	50
100	T	15120	5108	2554	1703	1277	1022	851	730	639	568	511	464	426	393	365	341	319
	S	-	1007	503	335	251	201	167	143	125	111	100	91	83	77	71	67	62
120	T	15120	6130	3065	2043	1532	1226	1022	876	766	681	613	557	511	472	438	409	383
	S	-	1209	604	403	302	241	201	172	151	134	120	109	100	93	86	80	75
140	T	15120	7151	3576	2384	1788	1430	1192	1022	894	795	715	650	596	550	511	477	447
	S	-	1411	705	470	352	282	235	201	176	156	141	128	117	108	100	94	88
160	T	15120	8173	4086	2724	2043	1635	1362	1168	1022	908	817	743	681	629	584	545	511
	S	-	1612	806	537	403	322	268	230	201	179	161	146	134	124	115	107	100
180	T	15120	9195	4597	3065	2299	1839	1532	1314	1149	1022	919	836	766	707	657	613	575
	S	-	1814	907	604	453	362	302	259	226	201	181	164	151	139	129	120	113
200	T	15120	10216	5108	3405	2554	2043	1703	1459	1277	1135	1022	929	851	786	730	681	639
	S	-	2015	1007	671	503	403	335	287	251	223	201	183	167	155	143	134	125
220	T	15120	11238	5619	3746	2809	2248	1873	1605	1405	1249	1124	1022	936	864	803	749	702
	S	-	2217	1108	739	554	443	369	316	277	246	221	201	184	170	158	147	138
240	T	15120	12259	6130	4086	3065	2452	2043	1751	1532	1362	1226	1114	1022	943	876	817	766
	S	-	2418	1209	806	604	483	403	345	302	268	241	219	201	186	172	161	151

TTM: Timber-Timber-Maximum | TTP: Timber-Timber-Partial | TCM: Timber-Concrete-Maximum | TCP: Timber-Concrete-Partial

T: $F_{T,Rk}$ load-carrying capacity of timber | S: $F_{S,Rk}$ load-carrying capacity of steel

Table B. 81 Angle bracket type 6504S, Variant TTP, Fastener GH Screw 5x60, Density 350 kg/m³Characteristic load-carrying capacity $F_{T,Rk}$ (N) for one / two angle brackets

angle bracket		1													2
f (mm)		0	10	20	30	40	50	60	70	80	90	100	110	120	0
$F_{T,Rk}$	T	1589	1032	735	490	368	294	245	210	184	163	147	134	123	3178
	S	201	130	87	58	43	35	29	25	21	19	17	15	14	402

Characteristic load-carrying capacity $F_{2/3,Rk}$ (N) for one / two angle brackets

angle bracket		1	2
$F_{2/3,Rk}$	T	5220	10440
	S	-	-

Characteristic load-carrying capacity $F_{4,Rk}$ (N) for one angle bracket

e (mm)		0	20	40	60	80	100	120	140	160	180	200	220	240	260	280	300	320
$F_{4,Rk}$	T	13590	1470	735	490	338	231	176	142	119	102	90	80	72	66	60	56	52
	S	-	186	93	62	40	27	21	16	14	12	10	9	8	7	7	6	6

Characteristic load-carrying capacity $F_{5,Rk}$ (N) for one angle bracket

b / e (mm)		0	20	40	60	80	100	120	140	160	180	200	220	240	260	280	300	320
0	T	403	891	4704	3136	2352	1882	1568	1344	1176	1045	941	855	784	724	672	627	588
	S	48	106	596	397	298	238	198	170	149	132	119	108	99	91	85	79	74
20	T	403	891	4530	3020	2265	1812	1510	1294	1133	1007	906	824	755	697	647	604	566
	S	48	106	596	397	298	238	198	170	149	132	119	108	99	91	85	79	74
40	T	403	891	4998	3332	2499	1999	1666	1428	1250	1111	1000	909	833	769	714	666	625
	S	48	106	596	397	298	238	198	170	149	132	119	108	99	91	85	79	74
60	T	403	891	4998	3332	2499	1999	1666	1428	1250	1111	1000	909	833	769	714	666	625
	S	48	106	596	397	298	238	198	170	149	132	119	108	99	91	85	79	74
80	T	403	891	4998	3332	2499	1999	1666	1428	1250	1111	1000	909	833	769	714	666	625
	S	48	106	596	397	298	238	198	170	149	132	119	108	99	91	85	79	74
100	T	403	891	4998	3332	2499	1999	1666	1428	1250	1111	1000	909	833	769	714	666	625
	S	48	106	596	397	298	238	198	170	149	132	119	108	99	91	85	79	74
120	T	403	891	4998	3332	2499	1999	1666	1428	1250	1111	1000	909	833	769	714	666	625
	S	48	106	596	397	298	238	198	170	149	132	119	108	99	91	85	79	74
140	T	403	891	4998	3332	2499	1999	1666	1428	1250	1111	1000	909	833	769	714	666	625
	S	48	106	596	397	298	238	198	170	149	132	119	108	99	91	85	79	74
160	T	403	891	4998	3332	2499	1999	1666	1428	1250	1111	1000	909	833	769	714	666	625
	S	48	106	596	397	298	238	198	170	149	132	119	108	99	91	85	79	74
180	T	403	891	4998	3332	2499	1999	1666	1428	1250	1111	1000	909	833	769	714	666	625
	S	48	106	596	397	298	238	198	170	149	132	119	108	99	91	85	79	74
200	T	403	891	4998	3332	2499	1999	1666	1428	1250	1111	1000	909	833	769	714	666	625
	S	48	106	596	397	298	238	198	170	149	132	119	108	99	91	85	79	74
220	T	403	891	4998	3332	2499	1999	1666	1428	1250	1111	1000	909	833	769	714	666	625
	S	48	106	596	397	298	238	198	170	149	132	119	108	99	91	85	79	74
240	T	403	891	4998	3332	2499	1999	1666	1428	1250	1111	1000	909	833	769	714	666	625
	S	48	106	596	397	298	238	198	170	149	132	119	108	99	91	85	79	74

Characteristic load-carrying capacity $F_{4/5,Rk}$ (N) for two angle brackets

b / e (mm)		0	20	40	60	80	100	120	140	160	180	200	220	240	260	280	300	320
0	T	23519	23519	23519	23519	23519	23519	23519	23519	23519	23519	23519	23519	23519	23519	23519	23519	23519
	S	-	-	-	-	-	-	-	-	-	-	-	-	-	-	-	-	-
20	T	23519	1589	795	530	397	318	265	227	199	177	159	144	132	122	114	106	99
	S	-	201	100	67	50	40	33	28	25	22	20	18	16	15	14	13	12
40	T	23519	3178	1589	1059	795	636	530	454	397	353	318	289	265	244	227	212	199
	S	-	403	201	134	100	80	67	57	50	44	40	36	33	31	28	26	25
60	T	23519	4768	2384	1589	1192	954	795	681	596	530	477	433	397	367	341	318	298
	S	-	604	302	201	151	120	100	86	75	67	60	54	50	46	43	40	37
80	T	23519	6357	3178	2119	1589	1271	1059	908	795	706	636	578	530	489	454	424	397
	S	-	806	403	268	201	161	134	115	100	89	80	73	67	62	57	53	50
100	T	23519	7946	3973	2649	1986	1589	1324	1135	993	883	795	722	662	611	568	530	497
	S	-	1007	503	335	251	201	167	143	125	111	100	91	83	77	71	67	62
120	T	23519	9535	4768	3178	2384	1907	1589	1362	1192	1059	954	867	795	733	681	636	596
	S	-	1209	604	403	302	241	201	172	151	134	120	109	100	93	86	80	75
140	T	23519	11124	5562	3708	2781	2225	1854	1589	1391	1236	1112	1011	927	856	795	742	695
	S	-	1411	705	470	352	282	235	201	176	156	141	128	117	108	100	94	88
160	T	23519	12714	6357	4238	3178	2543	2119	1816	1589	1413	1271	1156	1059	978	908	848	795
	S	-	1612	806	537	403	322	268	230	201	179	161	146	134	124	115	107	100
180	T	23519	14303	7151	4768	3576	2861	2384	2043	1788	1589	1430	1300	1192	1100	1022	954	894
	S	-	1814	907	604	453	362	302	259	226	201	181	164	151	139	129	120	113
200	T	23519	15892	7946	5297	3973	3178	2649	2270	1986	1766	1589	1445	1324	1222	1135	1059	993
	S	-	2015	1007	671	503	403	335	287	251	223	201	183	167	155	143	134	125
220	T	23519	17481	8741	5827	4370	3496	2914	2497	2185	1942	1748	1589	1457	1345	1249	1165	1093
	S	-	2217	1108	739	554	443	369	316	277	246	221	201	184	170	158	147	138
240	T	23519	19070	9535	6357	4768	3814	3178	2724	2384	2119	1907	1734	1589	1467	1362	1271	1192
	S	-	2418	1209	806	604	483	403	345	302	268	241	219	201	186	172	161	151

TTM: Timber-Timber-Maximum | TTP: Timber-Timber-Partial | TCM: Timber-Concrete-Maximum | TCP: Timber-Concrete-Partial

T: $F_{T,Rk}$ load-carrying capacity of timber | S: $F_{S,Rk}$ load-carrying capacity of steel

Table B. 82 Angle bracket type 6504S13, Variant TCM, Fastener GH Nail 4x40, Density 350 kg/m³Characteristic load-carrying capacity $F_{1,Rk}$ (N) for one / two angle brackets

angle bracket		1													2
f (mm)		0	10	20	30	40	50	60	70	80	90	100	110	120	0
$F_{1,Rk}$	T	15120	450	225	150	113	90	75	64	56	50	45	41	38	30240
	S	66	56	48	42	37	33	29	25	21	19	17	15	14	
k_t (-)		7,9	9,5	11,0	12,5	14,1	15,6	17,2	18,7	20,2	21,8	23,3	24,8	26,4	4,0

Characteristic load-carrying capacity $F_{2/3,Rk}$ (N) for one / two angle brackets

angle bracket		1	2
$F_{2/3,Rk}$	T	2570	5140
	S	-	-

Characteristic load-carrying capacity $F_{4,Rk}$ (N) for one angle bracket

e (mm)		0	20	40	60	80	100	120	140	160	180	200	220	240	260	280	300	320
$F_{4,Rk}$	T	-	-	1286	191	103	71	54	43	36	31	28	25	22	20	18	17	16
	S	-	172	86	57	40	27	21	16	14	12	10	9	8	7	7	6	6
k_t (-)		0,0	3,1	6,2	9,2	12,3	15,4	18,5	21,5	24,6	27,7	30,8	33,8	36,9	40,0	43,1	46,2	49,2

Characteristic load-carrying capacity $F_{5,Rk}$ (N) for one angle bracket

b / e (mm)		0	20	40	60	80	100	120	140	160	180	200	220	240	260	280	300	320
0	T	123	273	1530	1020	765	612	510	437	383	340	306	278	255	235	219	204	191
	S	48	106	596	397	298	238	198	170	149	132	119	108	99	91	85	79	74
20	T	123	273	1530	1020	765	612	510	437	383	340	306	278	255	235	219	204	191
	S	48	106	596	397	298	238	198	170	149	132	119	108	99	91	85	79	74
40	T	123	273	1530	1020	765	612	510	437	383	340	306	278	255	235	219	204	191
	S	48	106	596	397	298	238	198	170	149	132	119	108	99	91	85	79	74
60	T	123	273	1530	1020	765	612	510	437	383	340	306	278	255	235	219	204	191
	S	48	106	596	397	298	238	198	170	149	132	119	108	99	91	85	79	74
80	T	123	273	1530	1020	765	612	510	437	383	340	306	278	255	235	219	204	191
	S	48	106	596	397	298	238	198	170	149	132	119	108	99	91	85	79	74
100	T	123	273	1530	1020	765	612	510	437	383	340	306	278	255	235	219	204	191
	S	48	106	596	397	298	238	198	170	149	132	119	108	99	91	85	79	74
120	T	123	273	1530	1020	765	612	510	437	383	340	306	278	255	235	219	204	191
	S	48	106	596	397	298	238	198	170	149	132	119	108	99	91	85	79	74
140	T	123	273	1530	1020	765	612	510	437	383	340	306	278	255	235	219	204	191
	S	48	106	596	397	298	238	198	170	149	132	119	108	99	91	85	79	74
160	T	123	273	1530	1020	765	612	510	437	383	340	306	278	255	235	219	204	191
	S	48	106	596	397	298	238	198	170	149	132	119	108	99	91	85	79	74
180	T	123	273	1530	1020	765	612	510	437	383	340	306	278	255	235	219	204	191
	S	48	106	596	397	298	238	198	170	149	132	119	108	99	91	85	79	74
200	T	123	273	1530	1020	765	612	510	437	383	340	306	278	255	235	219	204	191
	S	48	106	596	397	298	238	198	170	149	132	119	108	99	91	85	79	74
220	T	123	273	1530	1020	765	612	510	437	383	340	306	278	255	235	219	204	191
	S	48	106	596	397	298	238	198	170	149	132	119	108	99	91	85	79	74
240	T	123	273	1530	1020	765	612	510	437	383	340	306	278	255	235	219	204	191
	S	48	106	596	397	298	238	198	170	149	132	119	108	99	91	85	79	74
$k_t \times b$ (-)		0,0	16,8	33,7	50,5	67,4	84,2	101,1	117,9	134,7	151,6	168,4	185,3	202,1	218,9	235,8	252,6	269,5

Characteristic load-carrying capacity $F_{4/5,Rk}$ (N) for two angle brackets

b / e (mm)		0	20	40	60	80	100	120	140	160	180	200	220	240	260	280	300	320
0	T	14400	14400	14400	14400	14400	14400	14400	14400	14400	14400	14400	14400	14400	14400	14400	14400	14400
	S	-	-	-	-	-	-	-	-	-	-	-	-	-	-	-	-	-
20	T	14400	14400	7560	5040	3780	3024	2520	2160	1890	1680	1512	1375	1260	1163	1080	1008	945
	S	-	66	33	22	16	13	11	9	8	7	6	6	5	5	4	4	4
40	T	14400	14400	14400	10080	7560	6048	5040	4320	3780	3360	3024	2749	2520	2326	2160	2016	1890
	S	-	133	66	44	33	26	22	19	16	14	13	12	11	10	9	8	8
60	T	14400	14400	14400	14400	11340	9072	7560	6480	5670	5040	4536	4124	3780	3489	3240	3024	2835
	S	-	200	100	66	50	40	33	28	25	22	20	18	16	15	14	13	12
80	T	14400	14400	14400	14400	14400	12096	10080	8640	7560	6720	6048	5498	5040	4652	4320	4032	3780
	S	-	267	133	89	66	53	44	38	33	29	26	24	22	20	19	17	16
100	T	14400	14400	14400	14400	14400	14400	12600	10800	9450	8400	7560	6873	6300	5815	5400	5040	4725
	S	-	334	167	111	83	66	55	47	41	37	33	30	27	25	23	22	20
120	T	14400	14400	14400	14400	14400	14400	14400	12960	11340	10080	9072	8247	7560	6978	6480	6048	5670
	S	-	401	200	133	100	80	66	57	50	44	40	36	33	30	28	26	25
140	T	14400	14400	14400	14400	14400	14400	14400	14400	13230	11760	10584	9622	8820	8142	7560	7056	6615
	S	-	468	234	156	117	93	78	66	58	52	46	42	39	36	33	31	29
160	T	14400	14400	14400	14400	14400	14400	14400	14400	14400	13440	12096	10996	10080	9305	8640	8064	7560
	S	-	535	267	178	133	107	89	76	66	59	53	48	44	41	38	35	33
180	T	14400	14400	14400	14400	14400	14400	14400	14400	14400	14400	13608	12371	11340	10468	9720	9072	8505
	S	-	602	301	200	150	120	100	86	75	66	60	54	50	46	43	40	37
200	T	14400	14400	14400	14400	14400	14400	14400	14400	14400	14400	14400	14400	13745	12600	11631	10800	10080
	S	-	669	334	223	167	133	111	95	83	74	66	60	55	51	47	44	41
220	T	14400	14400	14400	14400	14400	14400	14400	14400	14400	14400	14400	14400	14400	13860	12794	11880	11088
	S	-	736	368	245	184	147	122	105	92	81	73	66	61	56	52	49	46
240	T	14400	14400	14400	14400	14400	14400	14400	14400	14400	14400	14400	14400	14400	14400	13957	12960	12096
	S	-	803	401	267	200	160	133	114	100	89	80	73	66	61	57	53	50
$k_t \times b$ (-)		0,0	158,5	316,9	475,4	633,8	792,3	950,8	1109,2	1267,7	1426,2	1584,6	1743,1	1901,5	2060,0	2218,5	2376,9	2535,4

TTM: Timber-Timber-Maximum | TTP: Timber-Timber-Partial | TCM: Timber-Concrete-Maximum | TCP: Timber-Concrete-Partial

T: $F_{1,T,Rk}$ load-carrying capacity of timber | S: $F_{1,S,Rk}$ load-carrying capacity of steel

Table B. 83 Angle bracket type 6504S13, Variant TCM, Fastener GH Nail 4x60, Density 350 kg/m³Characteristic load-carrying capacity $F_{T,Rk}$ (N) for one / two angle brackets

angle bracket		1													2
f (mm)		0	10	20	30	40	50	60	70	80	90	100	110	120	0
$F_{T,Rk}$	T	18912	750	375	250	188	150	125	107	94	83	75	68	63	37824
	S	66	56	48	42	37	33	29	25	21	19	17	15	14	132
$k_t (-)$		7,9	9,5	11,0	12,5	14,1	15,6	17,2	18,7	20,2	21,8	23,3	24,8	26,4	4,0

Characteristic load-carrying capacity $F_{2/3,Rk}$ (N) for one / two angle brackets

angle bracket		1	2
$F_{2/3,Rk}$	T	3780	7560
	S	-	-

Characteristic load-carrying capacity $F_{4,Rk}$ (N) for one angle bracket

e (mm)		0	20	40	60	80	100	120	140	160	180	200	220	240	260	280	300	320
$F_{4,Rk}$	T	-	-	2143	319	172	118	90	72	61	52	46	41	37	34	31	28	26
	S	-	172	86	57	40	27	21	16	14	12	10	9	8	7	7	6	6
$k_t (-)$		0,0	3,1	6,2	9,2	12,3	15,4	18,5	21,5	24,6	27,7	30,8	33,8	36,9	40,0	43,1	46,2	49,2

Characteristic load-carrying capacity $F_{5,Rk}$ (N) for one angle bracket

b / e (mm)		0	20	40	60	80	100	120	140	160	180	200	220	240	260	280	300	320
0	T	205	455	2550	1700	1275	1020	850	729	638	567	510	464	425	392	364	340	319
	S	48	106	596	397	298	238	198	170	149	132	119	108	99	91	85	79	74
20	T	205	455	2550	1700	1275	1020	850	729	638	567	510	464	425	392	364	340	319
	S	48	106	596	397	298	238	198	170	149	132	119	108	99	91	85	79	74
40	T	205	455	2550	1700	1275	1020	850	729	638	567	510	464	425	392	364	340	319
	S	48	106	596	397	298	238	198	170	149	132	119	108	99	91	85	79	74
60	T	205	455	2550	1700	1275	1020	850	729	638	567	510	464	425	392	364	340	319
	S	48	106	596	397	298	238	198	170	149	132	119	108	99	91	85	79	74
80	T	205	455	2550	1700	1275	1020	850	729	638	567	510	464	425	392	364	340	319
	S	48	106	596	397	298	238	198	170	149	132	119	108	99	91	85	79	74
100	T	205	455	2550	1700	1275	1020	850	729	638	567	510	464	425	392	364	340	319
	S	48	106	596	397	298	238	198	170	149	132	119	108	99	91	85	79	74
120	T	205	455	2550	1700	1275	1020	850	729	638	567	510	464	425	392	364	340	319
	S	48	106	596	397	298	238	198	170	149	132	119	108	99	91	85	79	74
140	T	205	455	2550	1700	1275	1020	850	729	638	567	510	464	425	392	364	340	319
	S	48	106	596	397	298	238	198	170	149	132	119	108	99	91	85	79	74
160	T	205	455	2550	1700	1275	1020	850	729	638	567	510	464	425	392	364	340	319
	S	48	106	596	397	298	238	198	170	149	132	119	108	99	91	85	79	74
180	T	205	455	2550	1700	1275	1020	850	729	638	567	510	464	425	392	364	340	319
	S	48	106	596	397	298	238	198	170	149	132	119	108	99	91	85	79	74
200	T	205	455	2550	1700	1275	1020	850	729	638	567	510	464	425	392	364	340	319
	S	48	106	596	397	298	238	198	170	149	132	119	108	99	91	85	79	74
220	T	205	455	2550	1700	1275	1020	850	729	638	567	510	464	425	392	364	340	319
	S	48	106	596	397	298	238	198	170	149	132	119	108	99	91	85	79	74
240	T	205	455	2550	1700	1275	1020	850	729	638	567	510	464	425	392	364	340	319
	S	48	106	596	397	298	238	198	170	149	132	119	108	99	91	85	79	74
$k_t \times b (-)$		0,0	16,8	33,7	50,5	67,4	84,2	101,1	117,9	134,7	151,6	168,4	185,3	202,1	218,9	235,8	252,6	269,5

Characteristic load-carrying capacity $F_{4/5,Rk}$ (N) for two angle brackets

b / e (mm)		0	20	40	60	80	100	120	140	160	180	200	220	240	260	280	300	320
0	T	23999	23999	23999	23999	23999	23999	23999	23999	23999	23999	23999	23999	23999	23999	23999	23999	23999
	S	-	-	-	-	-	-	-	-	-	-	-	-	-	-	-	-	-
20	T	23999	18912	9456	6304	4728	3782	3152	2702	2364	2101	1891	1719	1576	1455	1351	1261	1182
	S	-	66	33	22	16	13	11	9	8	7	6	6	5	5	4	4	4
40	T	23999	24000	18912	12608	9456	7565	6304	5403	4728	4203	3782	3439	3152	2910	2702	2522	2364
	S	-	133	66	44	33	26	22	19	16	14	13	12	11	10	9	8	8
60	T	23999	24000	24000	18912	14184	11347	9456	8105	7092	6304	5674	5158	4728	4364	4053	3782	3546
	S	-	200	100	66	50	40	33	28	25	22	20	18	16	15	14	13	12
80	T	23999	24000	24000	24000	18912	15130	12608	10807	9456	8405	7565	6877	6304	5819	5403	5043	4728
	S	-	267	133	89	66	53	44	38	33	29	26	24	22	20	19	17	16
100	T	23999	24000	24000	24000	23640	18912	15760	13509	11820	10507	9456	8596	7880	7274	6754	6304	5910
	S	-	334	167	111	83	66	55	47	41	37	33	30	27	25	23	22	20
120	T	23999	24000	24000	24000	24000	22694	18912	16210	14184	12608	11347	10316	9456	8729	8105	7565	7092
	S	-	401	200	133	100	80	66	57	50	44	40	36	33	30	28	26	25
140	T	23999	24000	24000	24000	24000	22064	18912	16548	14709	13238	12035	11032	10183	9456	8826	8274	
	S	-	468	234	156	117	93	78	66	58	52	46	42	39	36	33	31	29
160	T	23999	24000	24000	24000	24000	24000	21614	18912	16811	15130	13754	12608	11638	10807	10086	9456	
	S	-	535	267	178	133	107	89	76	66	59	53	48	44	41	38	35	33
180	T	23999	24000	24000	24000	24000	24000	24000	21276	18912	17021	15473	14184	13093	12158	11347	10638	
	S	-	602	301	200	150	120	100	86	75	66	60	54	50	46	43	40	37
200	T	23999	24000	24000	24000	24000	24000	24000	23640	21013	18912	17193	15760	14548	13509	12608	11820	
	S	-	669	334	223	167	133	111	95	83	74	66	60	55	51	47	44	41
220	T	23999	24000	24000	24000	24000	24000	24000	24000	23115	20803	18912	17336	16002	14859	13869	13002	
	S	-	736	368	245	184	147	122	105	92	81	73	66	61	56	52	49	46
240	T	23999	24000	24000	24000	24000	24000	24000	24000	24000	24000	22694	20631	18912	17457	16210	15130	14184
	S	-	803	401	267	200	160	133	114	100	89	80	73	66	61	57	53	50
$k_t \times b (-)$		0,0	158,5	316,9	475,4	633,8	792,3	950,8	1109,2	1267,7	1426,2	1584,6	1743,1	1901,5	2060,0	2218,5	2376,9	2535,4

TTM: Timber-Timber-Maximum | TTP: Timber-Timber-Partial | TCM: Timber-Concrete-Maximum | TCP: Timber-Concrete-Partial

T: $F_{T,Rk}$ load-carrying capacity of timber | S: $F_{S,Rk}$ load-carrying capacity of steel

Table B. 84 Angle bracket type 6504S13, Variant TCM, Fastener GH Screw 5x40, Density 350 kg/m³Characteristic load-carrying capacity $F_{1,Rk}$ (N) for one / two angle brackets

angle bracket		1													2
f (mm)		0	10	20	30	40	50	60	70	80	90	100	110	120	0
$F_{1,Rk}$	T	16024	945	473	315	236	189	158	135	118	105	95	86	79	32048
	S	66	56	48	42	37	33	29	25	21	19	17	15	14	
k_t (-)		7,9	9,5	11,0	12,5	14,1	15,6	17,2	18,7	20,2	21,8	23,3	24,8	26,4	4,0

Characteristic load-carrying capacity $F_{2/3,Rk}$ (N) for one / two angle brackets

angle bracket		1	2
$F_{2/3,Rk}$	T	3740	7480
	S	-	-

Characteristic load-carrying capacity $F_{4,Rk}$ (N) for one angle bracket

e (mm)		0	20	40	60	80	100	120	140	160	180	200	220	240	260	280	300	320
$F_{4,Rk}$	T	-	-	2700	402	217	149	113	91	77	66	58	51	46	42	39	36	33
	S	-	172	86	57	40	27	21	16	14	12	10	9	8	7	7	6	6
k_t (-)		0,0	3,1	6,2	9,2	12,3	15,4	18,5	21,5	24,6	27,7	30,8	33,8	36,9	40,0	43,1	46,2	49,2

Characteristic load-carrying capacity $F_{5,Rk}$ (N) for one angle bracket

b / e (mm)		0	20	40	60	80	100	120	140	160	180	200	220	240	260	280	300	320
0	T	259	573	3213	2142	1607	1285	1071	918	803	714	643	584	536	494	459	428	402
	S	48	106	596	397	298	238	198	170	149	132	119	108	99	91	85	79	74
20	T	259	573	3213	2142	1607	1285	1071	918	803	714	643	584	536	494	459	428	402
	S	48	106	596	397	298	238	198	170	149	132	119	108	99	91	85	79	74
40	T	259	573	3213	2142	1607	1285	1071	918	803	714	643	584	536	494	459	428	402
	S	48	106	596	397	298	238	198	170	149	132	119	108	99	91	85	79	74
60	T	259	573	3213	2142	1607	1285	1071	918	803	714	643	584	536	494	459	428	402
	S	48	106	596	397	298	238	198	170	149	132	119	108	99	91	85	79	74
80	T	259	573	3213	2142	1607	1285	1071	918	803	714	643	584	536	494	459	428	402
	S	48	106	596	397	298	238	198	170	149	132	119	108	99	91	85	79	74
100	T	259	573	3213	2142	1607	1285	1071	918	803	714	643	584	536	494	459	428	402
	S	48	106	596	397	298	238	198	170	149	132	119	108	99	91	85	79	74
120	T	259	573	3213	2142	1607	1285	1071	918	803	714	643	584	536	494	459	428	402
	S	48	106	596	397	298	238	198	170	149	132	119	108	99	91	85	79	74
140	T	259	573	3213	2142	1607	1285	1071	918	803	714	643	584	536	494	459	428	402
	S	48	106	596	397	298	238	198	170	149	132	119	108	99	91	85	79	74
160	T	259	573	3213	2142	1607	1285	1071	918	803	714	643	584	536	494	459	428	402
	S	48	106	596	397	298	238	198	170	149	132	119	108	99	91	85	79	74
180	T	259	573	3213	2142	1607	1285	1071	918	803	714	643	584	536	494	459	428	402
	S	48	106	596	397	298	238	198	170	149	132	119	108	99	91	85	79	74
200	T	259	573	3213	2142	1607	1285	1071	918	803	714	643	584	536	494	459	428	402
	S	48	106	596	397	298	238	198	170	149	132	119	108	99	91	85	79	74
220	T	259	573	3213	2142	1607	1285	1071	918	803	714	643	584	536	494	459	428	402
	S	48	106	596	397	298	238	198	170	149	132	119	108	99	91	85	79	74
240	T	259	573	3213	2142	1607	1285	1071	918	803	714	643	584	536	494	459	428	402
	S	48	106	596	397	298	238	198	170	149	132	119	108	99	91	85	79	74
$k_t \times b$ (-)		0,0	16,8	33,7	50,5	67,4	84,2	101,1	117,9	134,7	151,6	168,4	185,3	202,1	218,9	235,8	252,6	269,5

Characteristic load-carrying capacity $F_{4/5,Rk}$ (N) for two angle brackets

b / e (mm)		0	20	40	60	80	100	120	140	160	180	200	220	240	260	280	300	320
0	T	30239	30239	30239	30239	30239	30239	30239	30239	30239	30239	30239	30239	30239	30239	30239	30239	30239
	S	-	-	-	-	-	-	-	-	-	-	-	-	-	-	-	-	-
20	T	30239	16024	8012	5341	4006	3205	2671	2289	2003	1780	1602	1457	1335	1233	1145	1068	1002
	S	-	66	33	22	16	13	11	9	8	7	6	6	5	5	4	4	4
40	T	30239	30240	16024	10683	8012	6410	5341	4578	4006	3561	3205	2913	2671	2465	2289	2137	2003
	S	-	133	66	44	33	26	22	19	16	14	13	12	11	10	9	8	8
60	T	30239	30240	24036	16024	12018	9614	8012	6867	6009	5341	4807	4370	4006	3698	3434	3205	3005
	S	-	200	100	66	50	40	33	28	25	22	20	18	16	15	14	13	12
80	T	30239	30240	30240	21365	16024	12819	10683	9157	8012	7122	6410	5827	5341	4930	4578	4273	4006
	S	-	267	133	89	66	53	44	38	33	29	26	24	22	20	19	17	16
100	T	30239	30240	30240	26707	20030	16024	13353	11446	10015	8902	8012	7284	6677	6163	5723	5341	5008
	S	-	334	167	111	83	66	55	47	41	37	33	30	27	25	23	22	20
120	T	30239	30240	30240	30240	24036	19229	16024	13735	12018	10683	9614	8740	8012	7396	6867	6410	6009
	S	-	401	200	133	100	80	66	57	50	44	40	36	33	30	28	26	25
140	T	30239	30240	30240	30240	28042	22434	18695	16024	14021	12463	11217	10197	9347	8628	8012	7478	7011
	S	-	468	234	156	117	93	78	66	58	52	46	42	39	36	33	31	29
160	T	30239	30240	30240	30240	30240	25638	21365	18313	16024	14244	12819	11654	10683	9861	9157	8546	8012
	S	-	535	267	178	133	107	89	76	66	59	53	48	44	41	38	35	33
180	T	30239	30240	30240	30240	30240	28843	24036	20602	18027	16024	14422	13111	12018	11094	10301	9614	9014
	S	-	602	301	200	150	120	100	86	75	66	60	54	50	46	43	40	37
200	T	30239	30240	30240	30240	30240	30240	26707	22891	20030	17804	16024	14567	13353	12326	11446	10683	10015
	S	-	669	334	223	167	133	111	95	83	74	66	60	55	51	47	44	41
220	T	30239	30240	30240	30240	30240	30240	29377	25181	22033	19585	17626	16024	14689	13559	12590	11751	11017
	S	-	736	368	245	184	147	122	105	92	81	73	66	61	56	52	49	46
240	T	30239	30240	30240	30240	30240	30240	30240	27470	24036	21365	19229	17481	16024	14791	13735	12819	12018
	S	-	803	401	267	200	160	133	114	100	89	80	73	66	61	57	53	50
$k_t \times b$ (-)		0,0	158,5	316,9	475,4	633,8	792,3	950,8	1109,2	1267,7	1426,2	1584,6	1743,1	1901,5	2060,0	2218,5	2376,9	2535,4

TTM: Timber-Timber-Maximum | TTP: Timber-Timber-Partial | TCM: Timber-Concrete-Maximum | TCP: Timber-Concrete-Partial

T: $F_{1,T,Rk}$ load-carrying capacity of timber | S: $F_{1,S,Rk}$ load-carrying capacity of steel

Table B. 85 Angle bracket type 6504S13, Variant TCM, Fastener GH Screw 5x60, Density 350 kg/m³Characteristic load-carrying capacity $F_{1,Rk}$ (N) for one / two angle brackets

angle bracket	1													2	
f (mm)	0	10	20	30	40	50	60	70	80	90	100	110	120	0	
$F_{1,Rk}$	T	18120	1470	735	490	368	294	245	210	184	163	147	134	123	36240
	S	66	56	48	42	37	33	29	25	21	19	17	15	14	132
k_t (-)	7,9	9,5	11,0	12,5	14,1	15,6	17,2	18,7	20,2	21,8	23,3	24,8	26,4	4,0	

Characteristic load-carrying capacity $F_{2/3,Rk}$ (N) for one / two angle brackets

angle bracket	1	2	
$F_{2/3,Rk}$	T	4570	9140
	S	-	-

Characteristic load-carrying capacity $F_{4,Rk}$ (N) for one angle bracket

e (mm)	0	20	40	60	80	100	120	140	160	180	200	220	240	260	280	300	320	
$F_{4,Rk}$	T	-	-	4200	626	338	231	176	142	119	102	90	80	72	66	60	56	52
	S	-	172	86	57	40	27	21	16	14	12	10	9	8	7	7	6	6
k_t (-)	0,0	3,1	6,2	9,2	12,3	15,4	18,5	21,5	24,6	27,7	30,8	33,8	36,9	40,0	43,1	46,2	49,2	

Characteristic load-carrying capacity $F_{5,Rk}$ (N) for one angle bracket

b / e (mm)	0	20	40	60	80	100	120	140	160	180	200	220	240	260	280	300	320	
0	T	403	891	4998	3332	2499	1999	1666	1428	1250	1111	1000	909	833	769	714	666	625
	S	48	106	596	397	298	238	198	170	149	132	119	108	99	91	85	79	74
20	T	403	891	4998	3332	2499	1999	1666	1428	1250	1111	1000	909	833	769	714	666	625
	S	48	106	596	397	298	238	198	170	149	132	119	108	99	91	85	79	74
40	T	403	891	4998	3332	2499	1999	1666	1428	1250	1111	1000	909	833	769	714	666	625
	S	48	106	596	397	298	238	198	170	149	132	119	108	99	91	85	79	74
60	T	403	891	4998	3332	2499	1999	1666	1428	1250	1111	1000	909	833	769	714	666	625
	S	48	106	596	397	298	238	198	170	149	132	119	108	99	91	85	79	74
80	T	403	891	4998	3332	2499	1999	1666	1428	1250	1111	1000	909	833	769	714	666	625
	S	48	106	596	397	298	238	198	170	149	132	119	108	99	91	85	79	74
100	T	403	891	4998	3332	2499	1999	1666	1428	1250	1111	1000	909	833	769	714	666	625
	S	48	106	596	397	298	238	198	170	149	132	119	108	99	91	85	79	74
120	T	403	891	4998	3332	2499	1999	1666	1428	1250	1111	1000	909	833	769	714	666	625
	S	48	106	596	397	298	238	198	170	149	132	119	108	99	91	85	79	74
140	T	403	891	4998	3332	2499	1999	1666	1428	1250	1111	1000	909	833	769	714	666	625
	S	48	106	596	397	298	238	198	170	149	132	119	108	99	91	85	79	74
160	T	403	891	4998	3332	2499	1999	1666	1428	1250	1111	1000	909	833	769	714	666	625
	S	48	106	596	397	298	238	198	170	149	132	119	108	99	91	85	79	74
180	T	403	891	4998	3332	2499	1999	1666	1428	1250	1111	1000	909	833	769	714	666	625
	S	48	106	596	397	298	238	198	170	149	132	119	108	99	91	85	79	74
200	T	403	891	4998	3332	2499	1999	1666	1428	1250	1111	1000	909	833	769	714	666	625
	S	48	106	596	397	298	238	198	170	149	132	119	108	99	91	85	79	74
220	T	403	891	4998	3332	2499	1999	1666	1428	1250	1111	1000	909	833	769	714	666	625
	S	48	106	596	397	298	238	198	170	149	132	119	108	99	91	85	79	74
240	T	403	891	4998	3332	2499	1999	1666	1428	1250	1111	1000	909	833	769	714	666	625
	S	48	106	596	397	298	238	198	170	149	132	119	108	99	91	85	79	74
$k_t \times b$ (-)	0,0	16,8	33,7	50,5	67,4	84,2	101,1	117,9	134,7	151,6	168,4	185,3	202,1	218,9	235,8	252,6	269,5	

Characteristic load-carrying capacity $F_{4/5,Rk}$ (N) for two angle brackets

b / e (mm)	0	20	40	60	80	100	120	140	160	180	200	220	240	260	280	300	320	
0	T	47040	47040	47040	47040	47040	47040	47040	47040	47040	47040	47040	47040	47040	47040	47040	47040	
	S	-	-	-	-	-	-	-	-	-	-	-	-	-	-	-	-	
20	T	47040	18120	9060	6040	4530	3624	3020	2589	2265	2013	1812	1647	1510	1394	1294	1208	1133
	S	-	66	33	22	16	13	11	9	8	7	6	6	5	5	4	4	4
40	T	47040	36240	18120	12080	9060	7248	6040	5177	4530	4027	3624	3295	3020	2788	2589	2416	2265
	S	-	133	66	44	33	26	22	19	16	14	13	12	11	10	9	8	8
60	T	47040	47040	27180	18120	13590	10872	9060	7766	6795	6040	5436	4942	4530	4182	3883	3624	3398
	S	-	200	100	66	50	40	33	28	25	22	20	18	16	15	14	13	12
80	T	47040	47040	36240	24160	18120	14496	12080	10354	9060	8053	7248	6589	6040	5575	5177	4832	4530
	S	-	267	133	89	66	53	44	38	33	29	26	24	22	20	19	17	16
100	T	47040	47040	45300	30200	22650	18120	15100	12943	11325	10067	9060	8236	7550	6969	6471	6040	5663
	S	-	334	167	111	83	66	55	47	41	37	33	30	27	25	23	22	20
120	T	47040	47040	47040	36240	27180	21744	18120	15531	13590	12080	10872	9884	9060	8363	7766	7248	6795
	S	-	401	200	133	100	80	66	57	50	44	40	36	33	30	28	26	25
140	T	47040	47040	47040	42280	31710	25368	21140	18120	15855	14093	12684	11531	10570	9757	9060	8456	7928
	S	-	468	234	156	117	93	78	66	58	52	46	42	39	36	33	31	29
160	T	47040	47040	47040	47040	36240	28992	24160	20709	18120	16107	14496	13178	12080	11151	10354	9664	9060
	S	-	535	267	178	133	107	89	76	66	59	53	48	44	41	38	35	33
180	T	47040	47040	47040	47040	40770	32616	27180	23297	20385	18120	16308	14825	13590	12545	11649	10872	10193
	S	-	602	301	200	150	120	100	86	75	66	60	54	50	46	43	40	37
200	T	47040	47040	47040	47040	45300	36240	30200	25886	22650	20133	18120	16473	15100	13938	12943	12080	11325
	S	-	669	334	223	167	133	111	95	83	74	66	60	55	51	47	44	41
220	T	47040	47040	47040	47040	47040	39864	33220	28474	24915	22147	19932	18120	16610	15332	14237	13288	12458
	S	-	736	368	245	184	147	122	105	92	81	73	66	61	56	52	49	46
240	T	47040	47040	47040	47040	47040	43488	36240	31063	27180	24160	21744	19767	18120	16726	15531	14496	13590
	S	-	803	401	267	200	160	133	114	100	89	80	73	66	61	57	53	50
$k_t \times b$ (-)	0,0	158,5	316,9	475,4	633,8	792,3	950,8	1109,2	1267,7	1426,2	1584,6	1743,1	1901,5	2060,0	2218,5	2376,9	2535,4	

TTM: Timber-Timber-Maximum | TTP: Timber-Timber-Partial | TCM: Timber-Concrete-Maximum | TCP: Timber-Concrete-Partial

T: $F_{1,T,Rk}$ load-carrying capacity of timber | S: $F_{1,S,Rk}$ load-carrying capacity of steel

Table B. 86 Angle bracket type 6504S13, Variant TCP, Fastener GH Nail 4x40, Density 350 kg/m³Characteristic load-carrying capacity $F_{1,Rk}$ (N) for one / two angle brackets

angle bracket		1													2
f (mm)		0	10	20	30	40	50	60	70	80	90	100	110	120	0
$F_{1,Rk}$	T	7560	450	225	150	113	90	75	64	56	50	45	41	38	15120
	S	66	56	48	42	37	33	29	25	21	19	17	15	14	132
k_t (-)		7,9	9,5	11,0	12,5	14,1	15,6	17,2	18,7	20,2	21,8	23,3	24,8	26,4	4,0

Characteristic load-carrying capacity $F_{2/3,Rk}$ (N) for one / two angle brackets

angle bracket		1	2
$F_{2/3,Rk}$	T	1400	2800
	S	-	-

Characteristic load-carrying capacity $F_{4,Rk}$ (N) for one angle bracket

e (mm)		0	20	40	60	80	100	120	140	160	180	200	220	240	260	280	300	320
$F_{4,Rk}$	T	-	-	1286	191	103	71	54	43	36	31	28	25	22	20	18	17	16
	S	-	172	86	57	40	27	21	16	14	12	10	9	8	7	7	6	6
k_t (-)		0,0	3,1	6,2	9,2	12,3	15,4	18,5	21,5	24,6	27,7	30,8	33,8	36,9	40,0	43,1	46,2	49,2

Characteristic load-carrying capacity $F_{5,Rk}$ (N) for one angle bracket

b / e (mm)		0	20	40	60	80	100	120	140	160	180	200	220	240	260	280	300	320
0	T	123	273	1530	1020	765	612	510	437	383	340	306	278	255	235	219	204	191
	S	48	106	596	397	298	238	198	170	149	132	119	108	99	91	85	79	74
20	T	123	273	1530	1020	765	612	510	437	383	340	306	278	255	235	219	204	191
	S	48	106	596	397	298	238	198	170	149	132	119	108	99	91	85	79	74
40	T	123	273	1530	1020	765	612	510	437	383	340	306	278	255	235	219	204	191
	S	48	106	596	397	298	238	198	170	149	132	119	108	99	91	85	79	74
60	T	123	273	1530	1020	765	612	510	437	383	340	306	278	255	235	219	204	191
	S	48	106	596	397	298	238	198	170	149	132	119	108	99	91	85	79	74
80	T	123	273	1530	1020	765	612	510	437	383	340	306	278	255	235	219	204	191
	S	48	106	596	397	298	238	198	170	149	132	119	108	99	91	85	79	74
100	T	123	273	1530	1020	765	612	510	437	383	340	306	278	255	235	219	204	191
	S	48	106	596	397	298	238	198	170	149	132	119	108	99	91	85	79	74
120	T	123	273	1530	1020	765	612	510	437	383	340	306	278	255	235	219	204	191
	S	48	106	596	397	298	238	198	170	149	132	119	108	99	91	85	79	74
140	T	123	273	1530	1020	765	612	510	437	383	340	306	278	255	235	219	204	191
	S	48	106	596	397	298	238	198	170	149	132	119	108	99	91	85	79	74
160	T	123	273	1530	1020	765	612	510	437	383	340	306	278	255	235	219	204	191
	S	48	106	596	397	298	238	198	170	149	132	119	108	99	91	85	79	74
180	T	123	273	1530	1020	765	612	510	437	383	340	306	278	255	235	219	204	191
	S	48	106	596	397	298	238	198	170	149	132	119	108	99	91	85	79	74
200	T	123	273	1530	1020	765	612	510	437	383	340	306	278	255	235	219	204	191
	S	48	106	596	397	298	238	198	170	149	132	119	108	99	91	85	79	74
220	T	123	273	1530	1020	765	612	510	437	383	340	306	278	255	235	219	204	191
	S	48	106	596	397	298	238	198	170	149	132	119	108	99	91	85	79	74
240	T	123	273	1530	1020	765	612	510	437	383	340	306	278	255	235	219	204	191
	S	48	106	596	397	298	238	198	170	149	132	119	108	99	91	85	79	74
$k_t \times b$ (-)		0,0	16,8	33,7	50,5	67,4	84,2	101,1	117,9	134,7	151,6	168,4	185,3	202,1	218,9	235,8	252,6	269,5

Characteristic load-carrying capacity $F_{4/5,Rk}$ (N) for two angle brackets

b / e (mm)		0	20	40	60	80	100	120	140	160	180	200	220	240	260	280	300	320
0	T	7199	7199	7199	7199	7199	7199	7199	7199	7199	7199	7199	7199	7199	7199	7199	7199	7199
	S	-	-	-	-	-	-	-	-	-	-	-	-	-	-	-	-	-
20	T	7199	7200	3780	2520	1890	1512	1260	1080	945	840	756	687	630	582	540	504	473
	S	-	66	33	22	16	13	11	9	8	7	6	6	5	5	4	4	4
40	T	7199	7200	7200	5040	3780	3024	2520	2160	1890	1680	1512	1375	1260	1163	1080	1008	945
	S	-	133	66	44	33	26	22	19	16	14	13	12	11	10	9	8	8
60	T	7199	7200	7200	7200	5670	4536	3780	3240	2835	2520	2268	2062	1890	1745	1620	1512	1418
	S	-	200	100	66	50	40	33	28	25	22	20	18	16	15	14	13	12
80	T	7199	7200	7200	7200	7200	6048	5040	4320	3780	3360	3024	2749	2520	2326	2160	2016	1890
	S	-	267	133	89	66	53	44	38	33	29	26	24	22	20	19	17	16
100	T	7199	7200	7200	7200	7200	6300	5400	4725	4200	3780	3436	3150	2908	2700	2520	2363	2363
	S	-	334	167	111	83	66	55	47	41	37	33	30	27	25	23	22	20
120	T	7199	7200	7200	7200	7200	7200	7200	6480	5670	5040	4536	4124	3780	3489	3240	3024	2835
	S	-	401	200	133	100	80	66	57	50	44	40	36	33	30	28	26	25
140	T	7199	7200	7200	7200	7200	7200	7200	7200	6615	5880	5292	4811	4410	4071	3780	3528	3308
	S	-	468	234	156	117	93	78	66	58	52	46	42	39	36	33	31	29
160	T	7199	7200	7200	7200	7200	7200	7200	7200	6720	6048	5498	5040	4652	4320	4032	3870	3780
	S	-	535	267	178	133	107	89	76	66	59	53	48	44	41	38	35	33
180	T	7199	7200	7200	7200	7200	7200	7200	7200	7200	7200	6804	6185	5670	5234	4860	4536	4253
	S	-	602	301	200	150	120	100	86	75	66	60	54	50	46	43	40	37
200	T	7199	7200	7200	7200	7200	7200	7200	7200	7200	7200	7200	6873	6300	5815	5400	5040	4725
	S	-	669	334	223	167	133	111	95	83	74	66	60	55	51	47	44	41
220	T	7199	7200	7200	7200	7200	7200	7200	7200	7200	7200	7200	7200	6930	6397	5940	5544	5198
	S	-	736	368	245	184	147	122	105	92	81	73	66	61	56	52	49	46
240	T	7199	7200	7200	7200	7200	7200	7200	7200	7200	7200	7200	7200	7200	6978	6480	6048	5670
	S	-	803	401	267	200	160	133	114	100	89	80	73	66	61	57	53	50
$k_t \times b$ (-)		0,0	158,5	316,9	475,4	633,8	792,3	950,8	1109,2	1267,7	1426,2	1584,6	1743,1	1901,5	2060,0	2218,5	2376,9	2535,4

TTM: Timber-Timber-Maximum | TTP: Timber-Timber-Partial | TCM: Timber-Concrete-Maximum | TCP: Timber-Concrete-Partial

T: $F_{1,T,Rk}$ load-carrying capacity of timber | S: $F_{1,S,Rk}$ load-carrying capacity of steel

Table B. 87 Angle bracket type 6504S13, Variant TCP, Fastener GH Nail 4x60, Density 350 kg/m³Characteristic load-carrying capacity $F_{1,Rk}$ (N) for one / two angle brackets

angle bracket	1													2	
f (mm)	0	10	20	30	40	50	60	70	80	90	100	110	120	0	
$F_{1,Rk}$	T	9456	750	375	250	188	150	125	107	94	83	75	68	63	18912
	S	66	56	48	42	37	33	29	25	21	19	17	15	14	132
k_t (-)	7,9	9,5	11,0	12,5	14,1	15,6	17,2	18,7	20,2	21,8	23,3	24,8	26,4	4,0	

Characteristic load-carrying capacity $F_{2/3,Rk}$ (N) for one / two angle brackets

angle bracket	1	2	
$F_{2/3,Rk}$	T	2120	4240
	S	-	-

Characteristic load-carrying capacity $F_{4,Rk}$ (N) for one angle bracket

e (mm)	0	20	40	60	80	100	120	140	160	180	200	220	240	260	280	300	320	
$F_{4,Rk}$	T	-	-	2143	319	172	118	90	72	61	52	46	41	37	34	31	28	26
	S	-	172	86	57	40	27	21	16	14	12	10	9	8	7	7	6	6
k_t (-)	0,0	3,1	6,2	9,2	12,3	15,4	18,5	21,5	24,6	27,7	30,8	33,8	36,9	40,0	43,1	46,2	49,2	

Characteristic load-carrying capacity $F_{5,Rk}$ (N) for one angle bracket

b / e (mm)	0	20	40	60	80	100	120	140	160	180	200	220	240	260	280	300	320	
0	T	205	455	2550	1700	1275	1020	850	729	638	567	510	464	425	392	364	340	319
	S	48	106	596	397	298	238	198	170	149	132	119	108	99	91	85	79	74
20	T	205	455	2550	1700	1275	1020	850	729	638	567	510	464	425	392	364	340	319
	S	48	106	596	397	298	238	198	170	149	132	119	108	99	91	85	79	74
40	T	205	455	2550	1700	1275	1020	850	729	638	567	510	464	425	392	364	340	319
	S	48	106	596	397	298	238	198	170	149	132	119	108	99	91	85	79	74
60	T	205	455	2550	1700	1275	1020	850	729	638	567	510	464	425	392	364	340	319
	S	48	106	596	397	298	238	198	170	149	132	119	108	99	91	85	79	74
80	T	205	455	2550	1700	1275	1020	850	729	638	567	510	464	425	392	364	340	319
	S	48	106	596	397	298	238	198	170	149	132	119	108	99	91	85	79	74
100	T	205	455	2550	1700	1275	1020	850	729	638	567	510	464	425	392	364	340	319
	S	48	106	596	397	298	238	198	170	149	132	119	108	99	91	85	79	74
120	T	205	455	2550	1700	1275	1020	850	729	638	567	510	464	425	392	364	340	319
	S	48	106	596	397	298	238	198	170	149	132	119	108	99	91	85	79	74
140	T	205	455	2550	1700	1275	1020	850	729	638	567	510	464	425	392	364	340	319
	S	48	106	596	397	298	238	198	170	149	132	119	108	99	91	85	79	74
160	T	205	455	2550	1700	1275	1020	850	729	638	567	510	464	425	392	364	340	319
	S	48	106	596	397	298	238	198	170	149	132	119	108	99	91	85	79	74
180	T	205	455	2550	1700	1275	1020	850	729	638	567	510	464	425	392	364	340	319
	S	48	106	596	397	298	238	198	170	149	132	119	108	99	91	85	79	74
200	T	205	455	2550	1700	1275	1020	850	729	638	567	510	464	425	392	364	340	319
	S	48	106	596	397	298	238	198	170	149	132	119	108	99	91	85	79	74
220	T	205	455	2550	1700	1275	1020	850	729	638	567	510	464	425	392	364	340	319
	S	48	106	596	397	298	238	198	170	149	132	119	108	99	91	85	79	74
240	T	205	455	2550	1700	1275	1020	850	729	638	567	510	464	425	392	364	340	319
	S	48	106	596	397	298	238	198	170	149	132	119	108	99	91	85	79	74
$k_t \times b$ (-)	0,0	16,8	33,7	50,5	67,4	84,2	101,1	117,9	134,7	151,6	168,4	185,3	202,1	218,9	235,8	252,6	269,5	

Characteristic load-carrying capacity $F_{4/5,Rk}$ (N) for two angle brackets

b / e (mm)	0	20	40	60	80	100	120	140	160	180	200	220	240	260	280	300	320	
0	T	12000	12000	12000	12000	12000	12000	12000	12000	12000	12000	12000	12000	12000	12000	12000	12000	
	S	-	-	-	-	-	-	-	-	-	-	-	-	-	-	-	-	
20	T	12000	9456	4728	3152	2364	1891	1576	1351	1182	1051	946	860	788	727	675	630	591
	S	-	66	33	22	16	13	11	9	8	7	6	6	5	5	4	4	4
40	T	12000	12000	9456	6304	4728	3782	3152	2702	2364	2101	1891	1719	1576	1455	1351	1261	1182
	S	-	133	66	44	33	26	22	19	16	14	13	12	11	10	9	8	8
60	T	12000	12000	12000	9456	7092	5674	4728	4053	3546	3152	2837	2579	2364	2182	2026	1891	1773
	S	-	200	100	66	50	40	33	28	25	22	20	18	16	15	14	13	12
80	T	12000	12000	12000	12000	9456	7565	6304	5403	4728	4203	3782	3439	3152	2910	2702	2522	2364
	S	-	267	133	89	66	53	44	38	33	29	26	24	22	20	19	17	16
100	T	12000	12000	12000	12000	11820	9456	7880	6754	5910	5253	4728	4298	3940	3637	3377	3152	2955
	S	-	334	167	111	83	66	55	47	41	37	33	30	27	25	23	22	20
120	T	12000	12000	12000	12000	11347	9456	8105	7092	6304	5674	5158	4728	4364	4053	3782	3546	3346
	S	-	401	200	133	100	80	66	57	50	44	40	36	33	30	28	26	25
140	T	12000	12000	12000	12000	12000	11032	9456	8274	7355	6619	6017	5516	5092	4728	4413	4137	3917
	S	-	468	234	156	117	93	78	66	58	52	46	42	39	36	33	31	29
160	T	12000	12000	12000	12000	12000	12000	10807	9456	8405	7565	6877	6304	5819	5403	5043	4728	4478
	S	-	535	267	178	133	107	89	76	66	59	53	48	44	41	38	35	33
180	T	12000	12000	12000	12000	12000	12000	12000	10638	9456	8510	7737	7092	6546	6079	5674	5319	5019
	S	-	602	301	200	150	120	100	86	75	66	60	54	50	46	43	40	37
200	T	12000	12000	12000	12000	12000	12000	12000	11820	10507	9456	8596	7880	7274	6754	6304	5910	5510
	S	-	669	334	223	167	133	111	95	83	74	66	60	55	51	47	44	41
220	T	12000	12000	12000	12000	12000	12000	12000	12000	11557	10402	9456	8668	8001	7430	6934	6501	6101
	S	-	736	368	245	184	147	122	105	92	81	73	66	61	56	52	49	46
240	T	12000	12000	12000	12000	12000	12000	12000	12000	12000	12000	11347	10316	9456	8729	8105	7565	7092
	S	-	803	401	267	200	160	133	114	100	89	80	73	66	61	57	53	50
$k_t \times b$ (-)	0,0	158,5	316,9	475,4	633,8	792,3	950,8	1109,2	1267,7	1426,2	1584,6	1743,1	1901,5	2060,0	2218,5	2376,9	2535,4	

TTM: Timber-Timber-Maximum | TTP: Timber-Timber-Partial | TCM: Timber-Concrete-Maximum | TCP: Timber-Concrete-Partial

T: $F_{1,T,Rk}$ load-carrying capacity of timber | S: $F_{1,S,Rk}$ load-carrying capacity of steel

Table B. 88 Angle bracket type 6504S13, Variant TCP, Fastener GH Screw 5x40, Density 350 kg/m³Characteristic load-carrying capacity $F_{1,Rk}$ (N) for one / two angle brackets

angle bracket		1													2
f (mm)		0	10	20	30	40	50	60	70	80	90	100	110	120	0
$F_{1,Rk}$	T	8012	945	473	315	236	189	158	135	118	105	95	86	79	16024
	S	66	56	48	42	37	33	29	25	21	19	17	15	14	
k_t (-)		7,9	9,5	11,0	12,5	14,1	15,6	17,2	18,7	20,2	21,8	23,3	24,8	26,4	4,0

Characteristic load-carrying capacity $F_{2/3,Rk}$ (N) for one / two angle brackets

angle bracket		1	2
$F_{2/3,Rk}$	T	2190	4380
	S	-	-

Characteristic load-carrying capacity $F_{4,Rk}$ (N) for one angle bracket

e (mm)		0	20	40	60	80	100	120	140	160	180	200	220	240	260	280	300	320
$F_{4,Rk}$	T	-	-	2700	402	217	149	113	91	77	66	58	51	46	42	39	36	33
	S	-	172	86	57	40	27	21	16	14	12	10	9	8	7	7	6	6
k_t (-)		0,0	3,1	6,2	9,2	12,3	15,4	18,5	21,5	24,6	27,7	30,8	33,8	36,9	40,0	43,1	46,2	49,2

Characteristic load-carrying capacity $F_{5,Rk}$ (N) for one angle bracket

b / e (mm)		0	20	40	60	80	100	120	140	160	180	200	220	240	260	280	300	320
0	T	259	573	3213	2142	1607	1285	1071	918	803	714	643	584	536	494	459	428	402
	S	48	106	596	397	298	238	198	170	149	132	119	108	99	91	85	79	74
20	T	259	573	3213	2142	1607	1285	1071	918	803	714	643	584	536	494	459	428	402
	S	48	106	596	397	298	238	198	170	149	132	119	108	99	91	85	79	74
40	T	259	573	3213	2142	1607	1285	1071	918	803	714	643	584	536	494	459	428	402
	S	48	106	596	397	298	238	198	170	149	132	119	108	99	91	85	79	74
60	T	259	573	3213	2142	1607	1285	1071	918	803	714	643	584	536	494	459	428	402
	S	48	106	596	397	298	238	198	170	149	132	119	108	99	91	85	79	74
80	T	259	573	3213	2142	1607	1285	1071	918	803	714	643	584	536	494	459	428	402
	S	48	106	596	397	298	238	198	170	149	132	119	108	99	91	85	79	74
100	T	259	573	3213	2142	1607	1285	1071	918	803	714	643	584	536	494	459	428	402
	S	48	106	596	397	298	238	198	170	149	132	119	108	99	91	85	79	74
120	T	259	573	3213	2142	1607	1285	1071	918	803	714	643	584	536	494	459	428	402
	S	48	106	596	397	298	238	198	170	149	132	119	108	99	91	85	79	74
140	T	259	573	3213	2142	1607	1285	1071	918	803	714	643	584	536	494	459	428	402
	S	48	106	596	397	298	238	198	170	149	132	119	108	99	91	85	79	74
160	T	259	573	3213	2142	1607	1285	1071	918	803	714	643	584	536	494	459	428	402
	S	48	106	596	397	298	238	198	170	149	132	119	108	99	91	85	79	74
180	T	259	573	3213	2142	1607	1285	1071	918	803	714	643	584	536	494	459	428	402
	S	48	106	596	397	298	238	198	170	149	132	119	108	99	91	85	79	74
200	T	259	573	3213	2142	1607	1285	1071	918	803	714	643	584	536	494	459	428	402
	S	48	106	596	397	298	238	198	170	149	132	119	108	99	91	85	79	74
220	T	259	573	3213	2142	1607	1285	1071	918	803	714	643	584	536	494	459	428	402
	S	48	106	596	397	298	238	198	170	149	132	119	108	99	91	85	79	74
240	T	259	573	3213	2142	1607	1285	1071	918	803	714	643	584	536	494	459	428	402
	S	48	106	596	397	298	238	198	170	149	132	119	108	99	91	85	79	74
$k_t \times b$ (-)		0,0	16,8	33,7	50,5	67,4	84,2	101,1	117,9	134,7	151,6	168,4	185,3	202,1	218,9	235,8	252,6	269,5

Characteristic load-carrying capacity $F_{4/5,Rk}$ (N) for two angle brackets

b / e (mm)		0	20	40	60	80	100	120	140	160	180	200	220	240	260	280	300	320
0	T	15120	15120	15120	15120	15120	15120	15120	15120	15120	15120	15120	15120	15120	15120	15120	15120	15120
	S	-	-	-	-	-	-	-	-	-	-	-	-	-	-	-	-	-
20	T	15120	8012	4006	2671	2003	1602	1335	1145	1002	890	801	728	668	616	572	534	501
	S	-	66	33	22	16	13	11	9	8	7	6	6	5	5	4	4	4
40	T	15120	15120	8012	5341	4006	3205	2671	2289	2003	1780	1602	1457	1335	1233	1145	1068	1002
	S	-	133	66	44	33	26	22	19	16	14	13	12	11	10	9	8	8
60	T	15120	15120	12018	8012	6009	4807	4006	3434	3005	2671	2404	2185	2003	1849	1717	1602	1502
	S	-	200	100	66	50	40	33	28	25	22	20	18	16	15	14	13	12
80	T	15120	15120	15120	10683	8012	6410	5341	4578	4006	3561	3205	2913	2671	2465	2289	2137	2003
	S	-	267	133	89	66	53	44	38	33	29	26	24	22	20	19	17	16
100	T	15120	15120	15120	13353	10015	8012	6677	5723	5008	4451	4006	3642	3338	3082	2861	2671	2504
	S	-	334	167	111	83	66	55	47	41	37	33	30	27	25	23	22	20
120	T	15120	15120	15120	15120	12018	9614	8012	6867	6009	5341	4807	4370	4006	3698	3434	3205	3005
	S	-	401	200	133	100	80	66	57	50	44	40	36	33	30	28	26	25
140	T	15120	15120	15120	15120	14021	11217	9347	8012	7011	6232	5608	5099	4674	4314	4006	3739	3505
	S	-	468	234	156	117	93	78	66	58	52	46	42	39	36	33	31	29
160	T	15120	15120	15120	15120	15120	12819	10683	9157	8012	7122	6410	5827	5341	4930	4578	4273	4006
	S	-	535	267	178	133	107	89	76	66	59	53	48	44	41	38	35	33
180	T	15120	15120	15120	15120	15120	14422	12018	10301	9014	8012	7211	6555	6009	5547	5151	4807	4507
	S	-	602	301	200	150	120	100	86	75	66	60	54	50	46	43	40	37
200	T	15120	15120	15120	15120	15120	15120	13353	11446	10015	8902	8012	7284	6677	6163	5723	5341	5008
	S	-	669	334	223	167	133	111	95	83	74	66	60	55	51	47	44	41
220	T	15120	15120	15120	15120	15120	15120	14689	12590	11017	9792	8813	8012	7344	6779	6295	5875	5508
	S	-	736	368	245	184	147	122	105	92	81	73	66	61	56	52	49	46
240	T	15120	15120	15120	15120	15120	15120	15120	13735	12018	10683	9614	8740	8012	7396	6867	6410	6009
	S	-	803	401	267	200	160	133	114	100	89	80	73	66	61	57	53	50
$k_t \times b$ (-)		0,0	158,5	316,9	475,4	633,8	792,3	950,8	1109,2	1267,7	1426,2	1584,6	1743,1	1901,5	2060,0	2218,5	2376,9	2535,4

TTM: Timber-Timber-Maximum | TTP: Timber-Timber-Partial | TCM: Timber-Concrete-Maximum | TCP: Timber-Concrete-Partial

T: $F_{1,T,Rk}$ load-carrying capacity of timber | S: $F_{1,S,Rk}$ load-carrying capacity of steel

Table B. 89 Angle bracket type 6504S13, Variant TCP, Fastener GH Screw 5x60, Density 350 kg/m³Characteristic load-carrying capacity $F_{1,Rk}$ (N) for one / two angle brackets

angle bracket	1													2	
f (mm)	0	10	20	30	40	50	60	70	80	90	100	110	120	0	
$F_{1,Rk}$	T	9060	1470	735	490	368	294	245	210	184	163	147	134	123	18120
	S	66	56	48	42	37	33	29	25	21	19	17	15	14	132
k_t (-)	7,9	9,5	11,0	12,5	14,1	15,6	17,2	18,7	20,2	21,8	23,3	24,8	26,4	4,0	

Characteristic load-carrying capacity $F_{2/3,Rk}$ (N) for one / two angle brackets

angle bracket	1	2	
$F_{2/3,Rk}$	T	2750	5500
	S	-	-

Characteristic load-carrying capacity $F_{4,Rk}$ (N) for one angle bracket

e (mm)	0	20	40	60	80	100	120	140	160	180	200	220	240	260	280	300	320	
$F_{4,Rk}$	T	-	-	4200	626	338	231	176	142	119	102	90	80	72	66	60	56	52
	S	-	172	86	57	40	27	21	16	14	12	10	9	8	7	7	6	6
k_t (-)	0,0	3,1	6,2	9,2	12,3	15,4	18,5	21,5	24,6	27,7	30,8	33,8	36,9	40,0	43,1	46,2	49,2	

Characteristic load-carrying capacity $F_{5,Rk}$ (N) for one angle bracket

b / e (mm)	0	20	40	60	80	100	120	140	160	180	200	220	240	260	280	300	320	
0	T	403	891	4998	3332	2499	1999	1666	1428	1250	1111	1000	909	833	769	714	666	625
	S	48	106	596	397	298	238	198	170	149	132	119	108	99	91	85	79	74
20	T	403	891	4530	3020	2265	1812	1510	1294	1133	1007	906	824	755	697	647	604	566
	S	48	106	596	397	298	238	198	170	149	132	119	108	99	91	85	79	74
40	T	403	891	4998	3332	2499	1999	1666	1428	1250	1111	1000	909	833	769	714	666	625
	S	48	106	596	397	298	238	198	170	149	132	119	108	99	91	85	79	74
60	T	403	891	4998	3332	2499	1999	1666	1428	1250	1111	1000	909	833	769	714	666	625
	S	48	106	596	397	298	238	198	170	149	132	119	108	99	91	85	79	74
80	T	403	891	4998	3332	2499	1999	1666	1428	1250	1111	1000	909	833	769	714	666	625
	S	48	106	596	397	298	238	198	170	149	132	119	108	99	91	85	79	74
100	T	403	891	4998	3332	2499	1999	1666	1428	1250	1111	1000	909	833	769	714	666	625
	S	48	106	596	397	298	238	198	170	149	132	119	108	99	91	85	79	74
120	T	403	891	4998	3332	2499	1999	1666	1428	1250	1111	1000	909	833	769	714	666	625
	S	48	106	596	397	298	238	198	170	149	132	119	108	99	91	85	79	74
140	T	403	891	4998	3332	2499	1999	1666	1428	1250	1111	1000	909	833	769	714	666	625
	S	48	106	596	397	298	238	198	170	149	132	119	108	99	91	85	79	74
160	T	403	891	4998	3332	2499	1999	1666	1428	1250	1111	1000	909	833	769	714	666	625
	S	48	106	596	397	298	238	198	170	149	132	119	108	99	91	85	79	74
180	T	403	891	4998	3332	2499	1999	1666	1428	1250	1111	1000	909	833	769	714	666	625
	S	48	106	596	397	298	238	198	170	149	132	119	108	99	91	85	79	74
200	T	403	891	4998	3332	2499	1999	1666	1428	1250	1111	1000	909	833	769	714	666	625
	S	48	106	596	397	298	238	198	170	149	132	119	108	99	91	85	79	74
220	T	403	891	4998	3332	2499	1999	1666	1428	1250	1111	1000	909	833	769	714	666	625
	S	48	106	596	397	298	238	198	170	149	132	119	108	99	91	85	79	74
240	T	403	891	4998	3332	2499	1999	1666	1428	1250	1111	1000	909	833	769	714	666	625
	S	48	106	596	397	298	238	198	170	149	132	119	108	99	91	85	79	74
$k_x \times b$ (-)	0,0	16,8	33,7	50,5	67,4	84,2	101,1	117,9	134,7	151,6	168,4	185,3	202,1	218,9	235,8	252,6	269,5	

Characteristic load-carrying capacity $F_{4/5,Rk}$ (N) for two angle brackets

b / e (mm)	0	20	40	60	80	100	120	140	160	180	200	220	240	260	280	300	320	
0	T	23519	23519	23519	23519	23519	23519	23519	23519	23519	23519	23519	23519	23519	23519	23519	23519	
	S	-	-	-	-	-	-	-	-	-	-	-	-	-	-	-	-	
20	T	23519	9060	4530	3020	2265	1812	1510	1294	1133	1007	906	824	755	697	647	604	566
	S	-	66	33	22	16	13	11	9	8	7	6	6	5	5	4	4	4
40	T	23519	18120	9060	6040	4530	3624	3020	2589	2265	2013	1812	1647	1510	1394	1294	1208	1133
	S	-	133	66	44	33	26	22	19	16	14	13	12	11	10	9	8	8
60	T	23519	23520	13590	9060	6795	5436	4530	3883	3398	3020	2718	2471	2265	2091	1941	1812	1699
	S	-	200	100	66	50	40	33	28	25	22	20	18	16	15	14	13	12
80	T	23519	23520	18120	12080	9060	7248	6040	5177	4530	4027	3624	3295	3020	2788	2589	2416	2265
	S	-	267	133	89	66	53	44	38	33	29	26	24	22	20	19	17	16
100	T	23519	23520	22650	15100	11325	9060	7550	6471	5663	5033	4530	4118	3775	3485	3236	3020	2831
	S	-	334	167	111	83	66	55	47	41	37	33	30	27	25	23	22	20
120	T	23519	23520	23520	18120	13590	10872	9060	7766	6795	6040	5436	4942	4530	4182	3883	3624	3398
	S	-	401	200	133	100	80	66	57	50	44	40	36	33	30	28	26	25
140	T	23519	23520	23520	21140	15855	12684	10570	9060	7928	7047	6342	5765	5285	4878	4530	4228	3964
	S	-	468	234	156	117	93	78	66	58	52	46	42	39	36	33	31	29
160	T	23519	23520	23520	23520	18120	14496	12080	10354	9060	8053	7248	6589	6040	5575	5177	4832	4530
	S	-	535	267	178	133	107	89	76	66	59	53	48	44	41	38	35	33
180	T	23519	23520	23520	23520	20385	16308	13590	11649	10193	9060	8154	7413	6795	6272	5824	5436	5096
	S	-	602	301	200	150	120	100	86	75	66	60	54	50	46	43	40	37
200	T	23519	23520	23520	23520	22650	18120	15100	12943	11325	10067	9060	8236	7550	6969	6471	6040	5663
	S	-	669	334	223	167	133	111	95	83	74	66	60	55	51	47	44	41
220	T	23519	23520	23520	23520	23520	19932	16610	14237	12458	11073	9966	9060	8305	7666	7119	6644	6229
	S	-	736	368	245	184	147	122	105	92	81	73	66	61	56	52	49	46
240	T	23519	23520	23520	23520	23520	21744	18120	15531	13590	12080	10872	9884	9060	8363	7766	7248	6795
	S	-	803	401	267	200	160	133	114	100	89	80	73	66	61	57	53	50
$k_x \times b$ (-)	0,0	158,5	316,9	475,4	633,8	792,3	950,8	1109,2	1267,7	1426,2	1584,6	1743,1	1901,5	2060,0	2218,5	2376,9	2535,4	

TTM: Timber-Timber-Maximum | TTP: Timber-Timber-Partial | TCM: Timber-Concrete-Maximum | TCP: Timber-Concrete-Partial

T: $F_{1,T,Rk}$ load-carrying capacity of timber | S: $F_{1,S,Rk}$ load-carrying capacity of steel

Table B. 90 Angle bracket type 6504S13, Variant TTM, Fastener GH Nail 4x40, Density 350 kg/m³Characteristic load-carrying capacity $F_{T,Rk}$ (N) for one / two angle brackets

angle bracket		1													2
f (mm)		0	10	20	30	40	50	60	70	80	90	100	110	120	0
$F_{T,Rk}$	T	486	316	225	150	113	90	75	64	56	50	45	41	38	973
	S	201	130	87	58	43	35	29	25	21	19	17	15	14	402

Characteristic load-carrying capacity $F_{2/3,Rk}$ (N) for one / two angle brackets

angle bracket		1	2
$F_{2/3,Rk}$	T	6000	12000
	S	-	-

Characteristic load-carrying capacity $F_{4,Rk}$ (N) for one angle bracket

e (mm)		0	20	40	60	80	100	120	140	160	180	200	220	240	260	280	300	320
$F_{4,Rk}$	T	22679	450	225	150	103	71	54	43	36	31	28	25	22	20	18	17	16
	S	-	186	93	62	40	27	21	16	14	12	10	9	8	7	7	6	6

Characteristic load-carrying capacity $F_{5,Rk}$ (N) for one angle bracket

b / e (mm)		0	20	40	60	80	100	120	140	160	180	200	220	240	260	280	300	320
0	T	123	273	1440	960	720	576	480	411	360	320	288	262	240	222	206	192	180
	S	48	106	596	397	298	238	198	170	149	132	119	108	99	91	85	79	74
20	T	123	273	1530	1020	765	612	510	437	383	340	306	278	255	235	219	204	191
	S	48	106	596	397	298	238	198	170	149	132	119	108	99	91	85	79	74
40	T	123	273	1530	1020	765	612	510	437	383	340	306	278	255	235	219	204	191
	S	48	106	596	397	298	238	198	170	149	132	119	108	99	91	85	79	74
60	T	123	273	1530	1020	765	612	510	437	383	340	306	278	255	235	219	204	191
	S	48	106	596	397	298	238	198	170	149	132	119	108	99	91	85	79	74
80	T	123	273	1530	1020	765	612	510	437	383	340	306	278	255	235	219	204	191
	S	48	106	596	397	298	238	198	170	149	132	119	108	99	91	85	79	74
100	T	123	273	1530	1020	765	612	510	437	383	340	306	278	255	235	219	204	191
	S	48	106	596	397	298	238	198	170	149	132	119	108	99	91	85	79	74
120	T	123	273	1530	1020	765	612	510	437	383	340	306	278	255	235	219	204	191
	S	48	106	596	397	298	238	198	170	149	132	119	108	99	91	85	79	74
140	T	123	273	1530	1020	765	612	510	437	383	340	306	278	255	235	219	204	191
	S	48	106	596	397	298	238	198	170	149	132	119	108	99	91	85	79	74
160	T	123	273	1530	1020	765	612	510	437	383	340	306	278	255	235	219	204	191
	S	48	106	596	397	298	238	198	170	149	132	119	108	99	91	85	79	74
180	T	123	273	1530	1020	765	612	510	437	383	340	306	278	255	235	219	204	191
	S	48	106	596	397	298	238	198	170	149	132	119	108	99	91	85	79	74
200	T	123	273	1530	1020	765	612	510	437	383	340	306	278	255	235	219	204	191
	S	48	106	596	397	298	238	198	170	149	132	119	108	99	91	85	79	74
220	T	123	273	1530	1020	765	612	510	437	383	340	306	278	255	235	219	204	191
	S	48	106	596	397	298	238	198	170	149	132	119	108	99	91	85	79	74
240	T	123	273	1530	1020	765	612	510	437	383	340	306	278	255	235	219	204	191
	S	48	106	596	397	298	238	198	170	149	132	119	108	99	91	85	79	74

Characteristic load-carrying capacity $F_{4/5,Rk}$ (N) for two angle brackets

b / e (mm)		0	20	40	60	80	100	120	140	160	180	200	220	240	260	280	300	320
0	T	14400	14400	14400	14400	14400	14400	14400	14400	14400	14400	14400	14400	14400	14400	14400	14400	14400
	S	-	-	-	-	-	-	-	-	-	-	-	-	-	-	-	-	-
20	T	14400	486	243	162	122	97	81	69	61	54	49	44	41	37	35	32	30
	S	-	201	100	67	50	40	33	28	25	22	20	18	16	15	14	13	12
40	T	14400	973	486	324	243	195	162	139	122	108	97	88	81	75	69	65	61
	S	-	403	201	134	100	80	67	57	50	44	40	36	33	31	28	26	25
60	T	14400	1459	730	486	365	292	243	208	182	162	146	133	122	112	104	97	91
	S	-	604	302	201	151	120	100	86	75	67	60	54	50	46	43	40	37
80	T	14400	1946	973	649	486	389	324	278	243	216	195	177	162	150	139	130	122
	S	-	806	403	268	201	161	134	115	100	89	80	73	67	62	57	53	50
100	T	14400	2432	1216	811	608	486	405	347	304	270	243	221	203	187	174	162	152
	S	-	1007	503	335	251	201	167	143	125	111	100	91	83	77	71	67	62
120	T	14400	2919	1459	973	730	584	486	417	365	324	292	265	243	225	208	195	182
	S	-	1209	604	403	302	241	201	172	151	134	120	109	100	93	86	80	75
140	T	14400	3405	1703	1135	851	681	568	486	426	378	341	310	284	262	243	227	213
	S	-	1411	705	470	352	282	235	201	176	156	141	128	117	108	100	94	88
160	T	14400	3892	1946	1297	973	778	649	556	486	432	389	354	324	299	278	259	243
	S	-	1612	806	537	403	322	268	230	201	179	161	146	134	124	115	107	100
180	T	14400	4378	2189	1459	1095	876	730	625	547	486	438	398	365	337	313	292	274
	S	-	1814	907	604	453	362	302	259	226	201	181	164	151	139	129	120	113
200	T	14400	4865	2432	1622	1216	973	811	695	608	541	486	442	405	374	347	324	304
	S	-	2015	1007	671	503	403	335	287	251	223	201	183	167	155	143	134	125
220	T	14400	5351	2676	1784	1338	1070	892	764	669	595	535	486	446	412	382	357	334
	S	-	2217	1108	739	554	443	369	316	277	246	221	201	184	170	158	147	138
240	T	14400	5838	2919	1946	1459	1168	973	834	730	649	584	531	486	449	417	389	365
	S	-	2418	1209	806	604	483	403	345	302	268	241	219	201	186	172	161	151

TTM: Timber-Timber-Maximum | TTP: Timber-Timber-Partial | TCM: Timber-Concrete-Maximum | TCP: Timber-Concrete-Partial

T: $F_{T,Rk}$ load-carrying capacity of timber | S: $F_{S,Rk}$ load-carrying capacity of steel

Table B. 91 Angle bracket type 6504S13, Variant TTM, Fastener GH Nail 4x60, Density 350 kg/m³Characteristic load-carrying capacity $F_{T,Rk}$ (N) for one / two angle brackets

angle bracket		1													2
f (mm)		0	10	20	30	40	50	60	70	80	90	100	110	120	0
$F_{T,Rk}$	T	811	526	375	250	188	150	125	107	94	83	75	68	63	1622
	S	201	130	87	58	43	35	29	25	21	19	17	15	14	402

Characteristic load-carrying capacity $F_{2/3,Rk}$ (N) for one / two angle brackets

angle bracket		1	2
$F_{2/3,Rk}$	T	7950	15900
	S	-	-

Characteristic load-carrying capacity $F_{4,Rk}$ (N) for one angle bracket

e (mm)		0	20	40	60	80	100	120	140	160	180	200	220	240	260	280	300	320
$F_{4,Rk}$	T	28367	750	375	250	172	118	90	72	61	52	46	41	37	34	31	28	26
	S	-	186	93	62	40	27	21	16	14	12	10	9	8	7	7	6	6

Characteristic load-carrying capacity $F_{5,Rk}$ (N) for one angle bracket

b / e (mm)		0	20	40	60	80	100	120	140	160	180	200	220	240	260	280	300	320
0	T	205	455	2400	1600	1200	960	800	686	600	533	480	436	400	369	343	320	300
	S	48	106	596	397	298	238	198	170	149	132	119	108	99	91	85	79	74
20	T	205	455	2550	1700	1275	1020	850	729	638	567	510	464	425	392	364	340	319
	S	48	106	596	397	298	238	198	170	149	132	119	108	99	91	85	79	74
40	T	205	455	2550	1700	1275	1020	850	729	638	567	510	464	425	392	364	340	319
	S	48	106	596	397	298	238	198	170	149	132	119	108	99	91	85	79	74
60	T	205	455	2550	1700	1275	1020	850	729	638	567	510	464	425	392	364	340	319
	S	48	106	596	397	298	238	198	170	149	132	119	108	99	91	85	79	74
80	T	205	455	2550	1700	1275	1020	850	729	638	567	510	464	425	392	364	340	319
	S	48	106	596	397	298	238	198	170	149	132	119	108	99	91	85	79	74
100	T	205	455	2550	1700	1275	1020	850	729	638	567	510	464	425	392	364	340	319
	S	48	106	596	397	298	238	198	170	149	132	119	108	99	91	85	79	74
120	T	205	455	2550	1700	1275	1020	850	729	638	567	510	464	425	392	364	340	319
	S	48	106	596	397	298	238	198	170	149	132	119	108	99	91	85	79	74
140	T	205	455	2550	1700	1275	1020	850	729	638	567	510	464	425	392	364	340	319
	S	48	106	596	397	298	238	198	170	149	132	119	108	99	91	85	79	74
160	T	205	455	2550	1700	1275	1020	850	729	638	567	510	464	425	392	364	340	319
	S	48	106	596	397	298	238	198	170	149	132	119	108	99	91	85	79	74
180	T	205	455	2550	1700	1275	1020	850	729	638	567	510	464	425	392	364	340	319
	S	48	106	596	397	298	238	198	170	149	132	119	108	99	91	85	79	74
200	T	205	455	2550	1700	1275	1020	850	729	638	567	510	464	425	392	364	340	319
	S	48	106	596	397	298	238	198	170	149	132	119	108	99	91	85	79	74
220	T	205	455	2550	1700	1275	1020	850	729	638	567	510	464	425	392	364	340	319
	S	48	106	596	397	298	238	198	170	149	132	119	108	99	91	85	79	74
240	T	205	455	2550	1700	1275	1020	850	729	638	567	510	464	425	392	364	340	319
	S	48	106	596	397	298	238	198	170	149	132	119	108	99	91	85	79	74

Characteristic load-carrying capacity $F_{4/5,Rk}$ (N) for two angle brackets

b / e (mm)		0	20	40	60	80	100	120	140	160	180	200	220	240	260	280	300	320
0	T	23999	23999	23999	23999	23999	23999	23999	23999	23999	23999	23999	23999	23999	23999	23999	23999	23999
	S	-	-	-	-	-	-	-	-	-	-	-	-	-	-	-	-	-
20	T	23999	811	405	270	203	162	135	116	101	90	81	74	68	62	58	54	51
	S	-	201	100	67	50	40	33	28	25	22	20	18	16	15	14	13	12
40	T	23999	1622	811	541	405	324	270	232	203	180	162	147	135	125	116	108	101
	S	-	403	201	134	100	80	67	57	50	44	40	36	33	31	28	26	25
60	T	23999	2432	1216	811	608	486	405	347	304	270	243	221	203	187	174	162	152
	S	-	604	302	201	151	120	100	86	75	67	60	54	50	46	43	40	37
80	T	23999	3243	1622	1081	811	649	541	463	405	360	324	295	270	249	232	216	203
	S	-	806	403	268	201	161	134	115	100	89	80	73	67	62	57	53	50
100	T	23999	4054	2027	1351	1014	811	676	579	507	450	405	369	338	312	290	270	253
	S	-	1007	503	335	251	201	167	143	125	111	100	91	83	77	71	67	62
120	T	23999	4865	2432	1622	1216	973	811	695	608	541	486	442	405	374	347	324	304
	S	-	1209	604	403	302	241	201	172	151	134	120	109	100	93	86	80	75
140	T	23999	5676	2838	1892	1419	1135	946	811	709	631	568	516	473	437	405	378	355
	S	-	1411	705	470	352	282	235	201	176	156	141	128	117	108	100	94	88
160	T	23999	6486	3243	2162	1622	1297	1081	927	811	721	649	590	541	499	463	432	405
	S	-	1612	806	537	403	322	268	230	201	179	161	146	134	124	115	107	100
180	T	23999	7297	3649	2432	1824	1459	1216	1042	912	811	730	663	608	561	521	486	456
	S	-	1814	907	604	453	362	302	259	226	201	181	164	151	139	129	120	113
200	T	23999	8108	4054	2703	2027	1622	1351	1158	1014	901	811	737	676	624	579	541	507
	S	-	2015	1007	671	503	403	335	287	251	223	201	183	167	155	143	134	125
220	T	23999	8919	4459	2973	2230	1784	1486	1274	1115	991	892	811	743	686	637	595	557
	S	-	2217	1108	739	554	443	369	316	277	246	221	201	184	170	158	147	138
240	T	23999	9730	4865	3243	2432	1946	1622	1390	1216	1081	973	885	811	748	695	649	608
	S	-	2418	1209	806	604	483	403	345	302	268	241	219	201	186	172	161	151

TTM: Timber-Timber-Maximum | TTP: Timber-Timber-Partial | TCM: Timber-Concrete-Maximum | TCP: Timber-Concrete-Partial

T: $F_{T,Rk}$ load-carrying capacity of timber | S: $F_{S,Rk}$ load-carrying capacity of steel

Table B. 92 Angle bracket type 6504S13, Variant TTM, Fastener GH Screw 5x40, Density 350 kg/m³Characteristic load-carrying capacity $F_{T,Rk}$ (N) for one / two angle brackets

angle bracket		1													2
f (mm)		0	10	20	30	40	50	60	70	80	90	100	110	120	0
$F_{T,Rk}$	T	1022	663	473	315	236	189	158	135	118	105	95	86	79	2043
	S	201	130	87	58	43	35	29	25	21	19	17	15	14	402

Characteristic load-carrying capacity $F_{2/3,Rk}$ (N) for one / two angle brackets

angle bracket		1	2
$F_{2/3,Rk}$	T	7250	14500
	S	-	-

Characteristic load-carrying capacity $F_{4,Rk}$ (N) for one angle bracket

e (mm)		0	20	40	60	80	100	120	140	160	180	200	220	240	260	280	300	320
$F_{4,Rk}$	T	24035	945	473	315	217	149	113	91	77	66	58	51	46	42	39	36	33
	S	-	186	93	62	40	27	21	16	14	12	10	9	8	7	7	6	6

Characteristic load-carrying capacity $F_{5,Rk}$ (N) for one angle bracket

b / e (mm)		0	20	40	60	80	100	120	140	160	180	200	220	240	260	280	300	320
0	T	259	573	3024	2016	1512	1210	1008	864	756	672	605	550	504	465	432	403	378
	S	48	106	596	397	298	238	198	170	149	132	119	108	99	91	85	79	74
20	T	259	573	3213	2142	1607	1285	1071	918	803	714	643	584	536	494	459	428	402
	S	48	106	596	397	298	238	198	170	149	132	119	108	99	91	85	79	74
40	T	259	573	3213	2142	1607	1285	1071	918	803	714	643	584	536	494	459	428	402
	S	48	106	596	397	298	238	198	170	149	132	119	108	99	91	85	79	74
60	T	259	573	3213	2142	1607	1285	1071	918	803	714	643	584	536	494	459	428	402
	S	48	106	596	397	298	238	198	170	149	132	119	108	99	91	85	79	74
80	T	259	573	3213	2142	1607	1285	1071	918	803	714	643	584	536	494	459	428	402
	S	48	106	596	397	298	238	198	170	149	132	119	108	99	91	85	79	74
100	T	259	573	3213	2142	1607	1285	1071	918	803	714	643	584	536	494	459	428	402
	S	48	106	596	397	298	238	198	170	149	132	119	108	99	91	85	79	74
120	T	259	573	3213	2142	1607	1285	1071	918	803	714	643	584	536	494	459	428	402
	S	48	106	596	397	298	238	198	170	149	132	119	108	99	91	85	79	74
140	T	259	573	3213	2142	1607	1285	1071	918	803	714	643	584	536	494	459	428	402
	S	48	106	596	397	298	238	198	170	149	132	119	108	99	91	85	79	74
160	T	259	573	3213	2142	1607	1285	1071	918	803	714	643	584	536	494	459	428	402
	S	48	106	596	397	298	238	198	170	149	132	119	108	99	91	85	79	74
180	T	259	573	3213	2142	1607	1285	1071	918	803	714	643	584	536	494	459	428	402
	S	48	106	596	397	298	238	198	170	149	132	119	108	99	91	85	79	74
200	T	259	573	3213	2142	1607	1285	1071	918	803	714	643	584	536	494	459	428	402
	S	48	106	596	397	298	238	198	170	149	132	119	108	99	91	85	79	74
220	T	259	573	3213	2142	1607	1285	1071	918	803	714	643	584	536	494	459	428	402
	S	48	106	596	397	298	238	198	170	149	132	119	108	99	91	85	79	74
240	T	259	573	3213	2142	1607	1285	1071	918	803	714	643	584	536	494	459	428	402
	S	48	106	596	397	298	238	198	170	149	132	119	108	99	91	85	79	74

Characteristic load-carrying capacity $F_{4/5,Rk}$ (N) for two angle brackets

b / e (mm)		0	20	40	60	80	100	120	140	160	180	200	220	240	260	280	300	320
0	T	30239	30239	30239	30239	30239	30239	30239	30239	30239	30239	30239	30239	30239	30239	30239	30239	30239
	S	-	-	-	-	-	-	-	-	-	-	-	-	-	-	-	-	-
20	T	30239	1022	511	341	255	204	170	146	128	114	102	93	85	79	73	68	64
	S	-	201	100	67	50	40	33	28	25	22	20	18	16	15	14	13	12
40	T	30239	2043	1022	681	511	409	341	292	255	227	204	186	170	157	146	136	128
	S	-	403	201	134	100	80	67	57	50	44	40	36	33	31	28	26	25
60	T	30239	3065	1532	1022	766	613	511	438	383	341	306	279	255	236	219	204	192
	S	-	604	302	201	151	120	100	86	75	67	60	54	50	46	43	40	37
80	T	30239	4086	2043	1362	1022	817	681	584	511	454	409	371	341	314	292	272	255
	S	-	806	403	268	201	161	134	115	100	89	80	73	67	62	57	53	50
100	T	30239	5108	2554	1703	1277	1022	851	730	639	568	511	464	426	393	365	341	319
	S	-	1007	503	335	251	201	167	143	125	111	100	91	83	77	71	67	62
120	T	30239	6130	3065	2043	1532	1226	1022	876	766	681	613	557	511	472	438	409	383
	S	-	1209	604	403	302	241	201	172	151	134	120	109	100	93	86	80	75
140	T	30239	7151	3576	2384	1788	1430	1192	1022	894	795	715	650	596	550	511	477	447
	S	-	1411	705	470	352	282	235	201	176	156	141	128	117	108	100	94	88
160	T	30239	8173	4086	2724	2043	1635	1362	1168	1022	908	817	743	681	629	584	545	511
	S	-	1612	806	537	403	322	268	230	201	179	161	146	134	124	115	107	100
180	T	30239	9195	4597	3065	2299	1839	1532	1314	1149	1022	919	836	766	707	657	613	575
	S	-	1814	907	604	453	362	302	259	226	201	181	164	151	139	129	120	113
200	T	30239	10216	5108	3405	2554	2043	1703	1459	1277	1135	1022	929	851	786	730	681	639
	S	-	2015	1007	671	503	403	335	287	251	223	201	183	167	155	143	134	125
220	T	30239	11238	5619	3746	2809	2248	1873	1605	1405	1249	1124	1022	936	864	803	749	702
	S	-	2217	1108	739	554	443	369	316	277	246	221	201	184	170	158	147	138
240	T	30239	12259	6130	4086	3065	2452	2043	1751	1532	1362	1226	1114	1022	943	876	817	766
	S	-	2418	1209	806	604	483	403	345	302	268	241	219	201	186	172	161	151

TTM: Timber-Timber-Maximum | TTP: Timber-Timber-Partial | TCM: Timber-Concrete-Maximum | TCP: Timber-Concrete-Partial

T: $F_{T,Rk}$ load-carrying capacity of timber | S: $F_{S,Rk}$ load-carrying capacity of steel

Table B. 93 Angle bracket type 6504S13, Variant TTM, Fastener GH Screw 5x60, Density 350 kg/m³Characteristic load-carrying capacity $F_{T,Rk}$ (N) for one / two angle brackets

angle bracket		1													2
f (mm)		0	10	20	30	40	50	60	70	80	90	100	110	120	0
$F_{T,Rk}$	T	1589	1032	735	490	368	294	245	210	184	163	147	134	123	3178
	S	201	130	87	58	43	35	29	25	21	19	17	15	14	402

Characteristic load-carrying capacity $F_{2/3,Rk}$ (N) for one / two angle brackets

angle bracket		1	2
$F_{2/3,Rk}$	T	8580	17160
	S	-	-

Characteristic load-carrying capacity $F_{4,Rk}$ (N) for one angle bracket

e (mm)		0	20	40	60	80	100	120	140	160	180	200	220	240	260	280	300	320
$F_{4,Rk}$	T	27179	1470	735	490	338	231	176	142	119	102	90	80	72	66	60	56	52
	S	-	186	93	62	40	27	21	16	14	12	10	9	8	7	7	6	6

Characteristic load-carrying capacity $F_{5,Rk}$ (N) for one angle bracket

b / e (mm)		0	20	40	60	80	100	120	140	160	180	200	220	240	260	280	300	320
0	T	403	891	4704	3136	2352	1882	1568	1344	1176	1045	941	855	784	724	672	627	588
	S	48	106	596	397	298	238	198	170	149	132	119	108	99	91	85	79	74
20	T	403	891	4998	3332	2499	1999	1666	1428	1250	1111	1000	909	833	769	714	666	625
	S	48	106	596	397	298	238	198	170	149	132	119	108	99	91	85	79	74
40	T	403	891	4998	3332	2499	1999	1666	1428	1250	1111	1000	909	833	769	714	666	625
	S	48	106	596	397	298	238	198	170	149	132	119	108	99	91	85	79	74
60	T	403	891	4998	3332	2499	1999	1666	1428	1250	1111	1000	909	833	769	714	666	625
	S	48	106	596	397	298	238	198	170	149	132	119	108	99	91	85	79	74
80	T	403	891	4998	3332	2499	1999	1666	1428	1250	1111	1000	909	833	769	714	666	625
	S	48	106	596	397	298	238	198	170	149	132	119	108	99	91	85	79	74
100	T	403	891	4998	3332	2499	1999	1666	1428	1250	1111	1000	909	833	769	714	666	625
	S	48	106	596	397	298	238	198	170	149	132	119	108	99	91	85	79	74
120	T	403	891	4998	3332	2499	1999	1666	1428	1250	1111	1000	909	833	769	714	666	625
	S	48	106	596	397	298	238	198	170	149	132	119	108	99	91	85	79	74
140	T	403	891	4998	3332	2499	1999	1666	1428	1250	1111	1000	909	833	769	714	666	625
	S	48	106	596	397	298	238	198	170	149	132	119	108	99	91	85	79	74
160	T	403	891	4998	3332	2499	1999	1666	1428	1250	1111	1000	909	833	769	714	666	625
	S	48	106	596	397	298	238	198	170	149	132	119	108	99	91	85	79	74
180	T	403	891	4998	3332	2499	1999	1666	1428	1250	1111	1000	909	833	769	714	666	625
	S	48	106	596	397	298	238	198	170	149	132	119	108	99	91	85	79	74
200	T	403	891	4998	3332	2499	1999	1666	1428	1250	1111	1000	909	833	769	714	666	625
	S	48	106	596	397	298	238	198	170	149	132	119	108	99	91	85	79	74
220	T	403	891	4998	3332	2499	1999	1666	1428	1250	1111	1000	909	833	769	714	666	625
	S	48	106	596	397	298	238	198	170	149	132	119	108	99	91	85	79	74
240	T	403	891	4998	3332	2499	1999	1666	1428	1250	1111	1000	909	833	769	714	666	625
	S	48	106	596	397	298	238	198	170	149	132	119	108	99	91	85	79	74

Characteristic load-carrying capacity $F_{4/5,Rk}$ (N) for two angle brackets

b / e (mm)		0	20	40	60	80	100	120	140	160	180	200	220	240	260	280	300	320
0	T	47040	47040	47040	47040	47040	47040	47040	47040	47040	47040	47040	47040	47040	47040	47040	47040	47040
	S	-	-	-	-	-	-	-	-	-	-	-	-	-	-	-	-	-
20	T	47040	1589	795	530	397	318	265	227	199	177	159	144	132	122	114	106	99
	S	-	201	100	67	50	40	33	28	25	22	20	18	16	15	14	13	12
40	T	47040	3178	1589	1059	795	636	530	454	397	353	318	289	265	244	227	212	199
	S	-	403	201	134	100	80	67	57	50	44	40	36	33	31	28	26	25
60	T	47040	4768	2384	1589	1192	954	795	681	596	530	477	433	397	367	341	318	298
	S	-	604	302	201	151	120	100	86	75	67	60	54	50	46	43	40	37
80	T	47040	6357	3178	2119	1589	1271	1059	908	795	706	636	578	530	489	454	424	397
	S	-	806	403	268	201	161	134	115	100	89	80	73	67	62	57	53	50
100	T	47040	7946	3973	2649	1986	1589	1324	1135	993	883	795	722	662	611	568	530	497
	S	-	1007	503	335	251	201	167	143	125	111	100	91	83	77	71	67	62
120	T	47040	9535	4768	3178	2384	1907	1589	1362	1192	1059	954	867	795	733	681	636	596
	S	-	1209	604	403	302	241	201	172	151	134	120	109	100	93	86	80	75
140	T	47040	11124	5562	3708	2781	2225	1854	1589	1391	1236	1112	1011	927	856	795	742	695
	S	-	1411	705	470	352	282	235	201	176	156	141	128	117	108	100	94	88
160	T	47040	12714	6357	4238	3178	2543	2119	1816	1589	1413	1271	1156	1059	978	908	848	795
	S	-	1612	806	537	403	322	268	230	201	179	161	146	134	124	115	107	100
180	T	47040	14303	7151	4768	3576	2861	2384	2043	1788	1589	1430	1300	1192	1100	1022	954	894
	S	-	1814	907	604	453	362	302	259	226	201	181	164	151	139	129	120	113
200	T	47040	15892	7946	5297	3973	3178	2649	2270	1986	1766	1589	1445	1324	1222	1135	1059	993
	S	-	2015	1007	671	503	403	335	287	251	223	201	183	167	155	143	134	125
220	T	47040	17481	8741	5827	4370	3496	2914	2497	2185	1942	1748	1589	1457	1345	1249	1165	1093
	S	-	2217	1108	739	554	443	369	316	277	246	221	201	184	170	158	147	138
240	T	47040	19070	9535	6357	4768	3814	3178	2724	2384	2119	1907	1734	1589	1467	1362	1271	1192
	S	-	2418	1209	806	604	483	403	345	302	268	241	219	201	186	172	161	151

TTM: Timber-Timber-Maximum | TTP: Timber-Timber-Partial | TCM: Timber-Concrete-Maximum | TCP: Timber-Concrete-Partial

T: $F_{T,Rk}$ load-carrying capacity of timber | S: $F_{S,Rk}$ load-carrying capacity of steel

Table B. 94 Angle bracket type 6504S13, Variant TTP, Fastener GH Nail 4x40, Density 350 kg/m³Characteristic load-carrying capacity $F_{1,Rk}$ (N) for one / two angle brackets

angle bracket		1													2
f (mm)		0	10	20	30	40	50	60	70	80	90	100	110	120	0
$F_{1,Rk}$	T	486	316	225	150	113	90	75	64	56	50	45	41	38	973
	S	201	130	87	58	43	35	29	25	21	19	17	15	14	402

Characteristic load-carrying capacity $F_{2/3,Rk}$ (N) for one / two angle brackets

angle bracket		1	2
$F_{2/3,Rk}$	T	3580	7160
	S	-	-

Characteristic load-carrying capacity $F_{4,Rk}$ (N) for one angle bracket

e (mm)		0	20	40	60	80	100	120	140	160	180	200	220	240	260	280	300	320
$F_{4,Rk}$	T	11340	450	225	150	103	71	54	43	36	31	28	25	22	20	18	17	16
	S	-	186	93	62	40	27	21	16	14	12	10	9	8	7	7	6	6

Characteristic load-carrying capacity $F_{5,Rk}$ (N) for one angle bracket

b / e (mm)		0	20	40	60	80	100	120	140	160	180	200	220	240	260	280	300	320
0	T	123	273	1440	960	720	576	480	411	360	320	288	262	240	222	206	192	180
	S	48	106	596	397	298	238	198	170	149	132	119	108	99	91	85	79	74
20	T	123	273	1530	1020	765	612	510	437	383	340	306	278	255	235	219	204	191
	S	48	106	596	397	298	238	198	170	149	132	119	108	99	91	85	79	74
40	T	123	273	1530	1020	765	612	510	437	383	340	306	278	255	235	219	204	191
	S	48	106	596	397	298	238	198	170	149	132	119	108	99	91	85	79	74
60	T	123	273	1530	1020	765	612	510	437	383	340	306	278	255	235	219	204	191
	S	48	106	596	397	298	238	198	170	149	132	119	108	99	91	85	79	74
80	T	123	273	1530	1020	765	612	510	437	383	340	306	278	255	235	219	204	191
	S	48	106	596	397	298	238	198	170	149	132	119	108	99	91	85	79	74
100	T	123	273	1530	1020	765	612	510	437	383	340	306	278	255	235	219	204	191
	S	48	106	596	397	298	238	198	170	149	132	119	108	99	91	85	79	74
120	T	123	273	1530	1020	765	612	510	437	383	340	306	278	255	235	219	204	191
	S	48	106	596	397	298	238	198	170	149	132	119	108	99	91	85	79	74
140	T	123	273	1530	1020	765	612	510	437	383	340	306	278	255	235	219	204	191
	S	48	106	596	397	298	238	198	170	149	132	119	108	99	91	85	79	74
160	T	123	273	1530	1020	765	612	510	437	383	340	306	278	255	235	219	204	191
	S	48	106	596	397	298	238	198	170	149	132	119	108	99	91	85	79	74
180	T	123	273	1530	1020	765	612	510	437	383	340	306	278	255	235	219	204	191
	S	48	106	596	397	298	238	198	170	149	132	119	108	99	91	85	79	74
200	T	123	273	1530	1020	765	612	510	437	383	340	306	278	255	235	219	204	191
	S	48	106	596	397	298	238	198	170	149	132	119	108	99	91	85	79	74
220	T	123	273	1530	1020	765	612	510	437	383	340	306	278	255	235	219	204	191
	S	48	106	596	397	298	238	198	170	149	132	119	108	99	91	85	79	74
240	T	123	273	1530	1020	765	612	510	437	383	340	306	278	255	235	219	204	191
	S	48	106	596	397	298	238	198	170	149	132	119	108	99	91	85	79	74

Characteristic load-carrying capacity $F_{4/5,Rk}$ (N) for two angle brackets

b / e (mm)		0	20	40	60	80	100	120	140	160	180	200	220	240	260	280	300	320
0	T	7199	7199	7199	7199	7199	7199	7199	7199	7199	7199	7199	7199	7199	7199	7199	7199	7199
	S	-	-	-	-	-	-	-	-	-	-	-	-	-	-	-	-	-
20	T	7199	486	243	162	122	97	81	69	61	54	49	44	41	37	35	32	30
	S	-	201	100	67	50	40	33	28	25	22	20	18	16	15	14	13	12
40	T	7199	973	486	324	243	195	162	139	122	108	97	88	81	75	69	65	61
	S	-	403	201	134	100	80	67	57	50	44	40	36	33	31	28	26	25
60	T	7199	1459	730	486	365	292	243	208	182	162	146	133	122	112	104	97	91
	S	-	604	302	201	151	120	100	86	75	67	60	54	50	46	43	40	37
80	T	7199	1946	973	649	486	389	324	278	243	216	195	177	162	150	139	130	122
	S	-	806	403	268	201	161	134	115	100	89	80	73	67	62	57	53	50
100	T	7199	2432	1216	811	608	486	405	347	304	270	243	221	203	187	174	162	152
	S	-	1007	503	335	251	201	167	143	125	111	100	91	83	77	71	67	62
120	T	7199	2919	1459	973	730	584	486	417	365	324	292	265	243	225	208	195	182
	S	-	1209	604	403	302	241	201	172	151	134	120	109	100	93	86	80	75
140	T	7199	3405	1703	1135	851	681	568	486	426	378	341	310	284	262	243	227	213
	S	-	1411	705	470	352	282	235	201	176	156	141	128	117	108	100	94	88
160	T	7199	3892	1946	1297	973	778	649	556	486	432	389	354	324	299	278	259	243
	S	-	1612	806	537	403	322	268	230	201	179	161	146	134	124	115	107	100
180	T	7199	4378	2189	1459	1095	876	730	625	547	486	438	398	365	337	313	292	274
	S	-	1814	907	604	453	362	302	259	226	201	181	164	151	139	129	120	113
200	T	7199	4865	2432	1622	1216	973	811	695	608	541	486	442	405	374	347	324	304
	S	-	2015	1007	671	503	403	335	287	251	223	201	183	167	155	143	134	125
220	T	7199	5351	2676	1784	1338	1070	892	764	669	595	535	486	446	412	382	357	334
	S	-	2217	1108	739	554	443	369	316	277	246	221	201	184	170	158	147	138
240	T	7199	5838	2919	1946	1459	1168	973	834	730	649	584	531	486	449	417	389	365
	S	-	2418	1209	806	604	483	403	345	302	268	241	219	201	186	172	161	151

TTM: Timber-Timber-Maximum | TTP: Timber-Timber-Partial | TCM: Timber-Concrete-Maximum | TCP: Timber-Concrete-Partial

T: $F_{1,T,Rk}$ load-carrying capacity of timber | S: $F_{1,S,Rk}$ load-carrying capacity of steel

Table B. 95 Angle bracket type 6504S13, Variant TTP, Fastener GH Nail 4x60, Density 350 kg/m³Characteristic load-carrying capacity $F_{1,Rk}$ (N) for one / two angle brackets

angle bracket		1													2
f (mm)		0	10	20	30	40	50	60	70	80	90	100	110	120	0
$F_{1,Rk}$	T	811	526	375	250	188	150	125	107	94	83	75	68	63	1622
	S	201	130	87	58	43	35	29	25	21	19	17	15	14	402

Characteristic load-carrying capacity $F_{2/3,Rk}$ (N) for one / two angle brackets

angle bracket		1	2
$F_{2/3,Rk}$	T	4750	9500
	S	-	-

Characteristic load-carrying capacity $F_{4,Rk}$ (N) for one angle bracket

e (mm)		0	20	40	60	80	100	120	140	160	180	200	220	240	260	280	300	320
$F_{4,Rk}$	T	14184	750	375	250	172	118	90	72	61	52	46	41	37	34	31	28	26
	S	-	186	93	62	40	27	21	16	14	12	10	9	8	7	7	6	6

Characteristic load-carrying capacity $F_{5,Rk}$ (N) for one angle bracket

b / e (mm)		0	20	40	60	80	100	120	140	160	180	200	220	240	260	280	300	320
0	T	205	455	2400	1600	1200	960	800	686	600	533	480	436	400	369	343	320	300
	S	48	106	596	397	298	238	198	170	149	132	119	108	99	91	85	79	74
20	T	205	455	2550	1700	1275	1020	850	729	638	567	510	464	425	392	364	340	319
	S	48	106	596	397	298	238	198	170	149	132	119	108	99	91	85	79	74
40	T	205	455	2550	1700	1275	1020	850	729	638	567	510	464	425	392	364	340	319
	S	48	106	596	397	298	238	198	170	149	132	119	108	99	91	85	79	74
60	T	205	455	2550	1700	1275	1020	850	729	638	567	510	464	425	392	364	340	319
	S	48	106	596	397	298	238	198	170	149	132	119	108	99	91	85	79	74
80	T	205	455	2550	1700	1275	1020	850	729	638	567	510	464	425	392	364	340	319
	S	48	106	596	397	298	238	198	170	149	132	119	108	99	91	85	79	74
100	T	205	455	2550	1700	1275	1020	850	729	638	567	510	464	425	392	364	340	319
	S	48	106	596	397	298	238	198	170	149	132	119	108	99	91	85	79	74
120	T	205	455	2550	1700	1275	1020	850	729	638	567	510	464	425	392	364	340	319
	S	48	106	596	397	298	238	198	170	149	132	119	108	99	91	85	79	74
140	T	205	455	2550	1700	1275	1020	850	729	638	567	510	464	425	392	364	340	319
	S	48	106	596	397	298	238	198	170	149	132	119	108	99	91	85	79	74
160	T	205	455	2550	1700	1275	1020	850	729	638	567	510	464	425	392	364	340	319
	S	48	106	596	397	298	238	198	170	149	132	119	108	99	91	85	79	74
180	T	205	455	2550	1700	1275	1020	850	729	638	567	510	464	425	392	364	340	319
	S	48	106	596	397	298	238	198	170	149	132	119	108	99	91	85	79	74
200	T	205	455	2550	1700	1275	1020	850	729	638	567	510	464	425	392	364	340	319
	S	48	106	596	397	298	238	198	170	149	132	119	108	99	91	85	79	74
220	T	205	455	2550	1700	1275	1020	850	729	638	567	510	464	425	392	364	340	319
	S	48	106	596	397	298	238	198	170	149	132	119	108	99	91	85	79	74
240	T	205	455	2550	1700	1275	1020	850	729	638	567	510	464	425	392	364	340	319
	S	48	106	596	397	298	238	198	170	149	132	119	108	99	91	85	79	74

Characteristic load-carrying capacity $F_{4/5,Rk}$ (N) for two angle brackets

b / e (mm)		0	20	40	60	80	100	120	140	160	180	200	220	240	260	280	300	320
0	T	12000	12000	12000	12000	12000	12000	12000	12000	12000	12000	12000	12000	12000	12000	12000	12000	12000
	S	-	-	-	-	-	-	-	-	-	-	-	-	-	-	-	-	-
20	T	12000	811	405	270	203	162	135	116	101	90	81	74	68	62	58	54	51
	S	-	201	100	67	50	40	33	28	25	22	20	18	16	15	14	13	12
40	T	12000	1622	811	541	405	324	270	232	203	180	162	147	135	125	116	108	101
	S	-	403	201	134	100	80	67	57	50	44	40	36	33	31	28	26	25
60	T	12000	2432	1216	811	608	486	405	347	304	270	243	221	203	187	174	162	152
	S	-	604	302	201	151	120	100	86	75	67	60	54	50	46	43	40	37
80	T	12000	3243	1622	1081	811	649	541	463	405	360	324	295	270	249	232	216	203
	S	-	806	403	268	201	161	134	115	100	89	80	73	67	62	57	53	50
100	T	12000	4054	2027	1351	1014	811	676	579	507	450	405	369	338	312	290	270	253
	S	-	1007	503	335	251	201	167	143	125	111	100	91	83	77	71	67	62
120	T	12000	4865	2432	1622	1216	973	811	695	608	541	486	442	405	374	347	324	304
	S	-	1209	604	403	302	241	201	172	151	134	120	109	100	93	86	80	75
140	T	12000	5676	2838	1892	1419	1135	946	811	709	631	568	516	473	437	405	378	355
	S	-	1411	705	470	352	282	235	201	176	156	141	128	117	108	100	94	88
160	T	12000	6486	3243	2162	1622	1297	1081	927	811	721	649	590	541	499	463	432	405
	S	-	1612	806	537	403	322	268	230	201	179	161	146	134	124	115	107	100
180	T	12000	7297	3649	2432	1824	1459	1216	1042	912	811	730	663	608	561	521	486	456
	S	-	1814	907	604	453	362	302	259	226	201	181	164	151	139	129	120	113
200	T	12000	8108	4054	2703	2027	1622	1351	1158	1014	901	811	737	676	624	579	541	507
	S	-	2015	1007	671	503	403	335	287	251	223	201	183	167	155	143	134	125
220	T	12000	8919	4459	2973	2230	1784	1486	1274	1115	991	892	811	743	686	637	595	557
	S	-	2217	1108	739	554	443	369	316	277	246	221	201	184	170	158	147	138
240	T	12000	9730	4865	3243	2432	1946	1622	1390	1216	1081	973	885	811	748	695	649	608
	S	-	2418	1209	806	604	483	403	345	302	268	241	219	201	186	172	161	151

TTM: Timber-Timber-Maximum | TTP: Timber-Timber-Partial | TCM: Timber-Concrete-Maximum | TCP: Timber-Concrete-Partial

T: $F_{1,T,Rk}$ load-carrying capacity of timber | S: $F_{1,S,Rk}$ load-carrying capacity of steel

Table B. 96 Angle bracket type 6504S13, Variant TTP, Fastener GH Screw 5x40, Density 350 kg/m³Characteristic load-carrying capacity $F_{1,Rk}$ (N) for one / two angle brackets

angle bracket		1													2
f (mm)		0	10	20	30	40	50	60	70	80	90	100	110	120	0
$F_{1,Rk}$	T	1022	663	473	315	236	189	158	135	118	105	95	86	79	2043
	S	201	130	87	58	43	35	29	25	21	19	17	15	14	402

Characteristic load-carrying capacity $F_{2/3,Rk}$ (N) for one / two angle brackets

angle bracket		1	2
$F_{2/3,Rk}$	T	4360	8720
	S	-	-

Characteristic load-carrying capacity $F_{4,Rk}$ (N) for one angle bracket

e (mm)		0	20	40	60	80	100	120	140	160	180	200	220	240	260	280	300	320
$F_{4,Rk}$	T	12018	945	473	315	217	149	113	91	77	66	58	51	46	42	39	36	33
	S	-	186	93	62	40	27	21	16	14	12	10	9	8	7	7	6	6

Characteristic load-carrying capacity $F_{5,Rk}$ (N) for one angle bracket

b / e (mm)		0	20	40	60	80	100	120	140	160	180	200	220	240	260	280	300	320
0	T	259	573	3024	2016	1512	1210	1008	864	756	672	605	550	504	465	432	403	378
	S	48	106	596	397	298	238	198	170	149	132	119	108	99	91	85	79	74
20	T	259	573	3213	2142	1607	1285	1071	918	803	714	643	584	536	494	459	428	402
	S	48	106	596	397	298	238	198	170	149	132	119	108	99	91	85	79	74
40	T	259	573	3213	2142	1607	1285	1071	918	803	714	643	584	536	494	459	428	402
	S	48	106	596	397	298	238	198	170	149	132	119	108	99	91	85	79	74
60	T	259	573	3213	2142	1607	1285	1071	918	803	714	643	584	536	494	459	428	402
	S	48	106	596	397	298	238	198	170	149	132	119	108	99	91	85	79	74
80	T	259	573	3213	2142	1607	1285	1071	918	803	714	643	584	536	494	459	428	402
	S	48	106	596	397	298	238	198	170	149	132	119	108	99	91	85	79	74
100	T	259	573	3213	2142	1607	1285	1071	918	803	714	643	584	536	494	459	428	402
	S	48	106	596	397	298	238	198	170	149	132	119	108	99	91	85	79	74
120	T	259	573	3213	2142	1607	1285	1071	918	803	714	643	584	536	494	459	428	402
	S	48	106	596	397	298	238	198	170	149	132	119	108	99	91	85	79	74
140	T	259	573	3213	2142	1607	1285	1071	918	803	714	643	584	536	494	459	428	402
	S	48	106	596	397	298	238	198	170	149	132	119	108	99	91	85	79	74
160	T	259	573	3213	2142	1607	1285	1071	918	803	714	643	584	536	494	459	428	402
	S	48	106	596	397	298	238	198	170	149	132	119	108	99	91	85	79	74
180	T	259	573	3213	2142	1607	1285	1071	918	803	714	643	584	536	494	459	428	402
	S	48	106	596	397	298	238	198	170	149	132	119	108	99	91	85	79	74
200	T	259	573	3213	2142	1607	1285	1071	918	803	714	643	584	536	494	459	428	402
	S	48	106	596	397	298	238	198	170	149	132	119	108	99	91	85	79	74
220	T	259	573	3213	2142	1607	1285	1071	918	803	714	643	584	536	494	459	428	402
	S	48	106	596	397	298	238	198	170	149	132	119	108	99	91	85	79	74
240	T	259	573	3213	2142	1607	1285	1071	918	803	714	643	584	536	494	459	428	402
	S	48	106	596	397	298	238	198	170	149	132	119	108	99	91	85	79	74

Characteristic load-carrying capacity $F_{4/5,Rk}$ (N) for two angle brackets

b / e (mm)		0	20	40	60	80	100	120	140	160	180	200	220	240	260	280	300	320
0	T	15120	15120	15120	15120	15120	15120	15120	15120	15120	15120	15120	15120	15120	15120	15120	15120	15120
	S	-	-	-	-	-	-	-	-	-	-	-	-	-	-	-	-	-
20	T	15120	1022	511	341	255	204	170	146	128	114	102	93	85	79	73	68	64
	S	-	201	100	67	50	40	33	28	25	22	20	18	16	15	14	13	12
40	T	15120	2043	1022	681	511	409	341	292	255	227	204	186	170	157	146	136	128
	S	-	403	201	134	100	80	67	57	50	44	40	36	33	31	28	26	25
60	T	15120	3065	1532	1022	766	613	511	438	383	341	306	279	255	236	219	204	192
	S	-	604	302	201	151	120	100	86	75	67	60	54	50	46	43	40	37
80	T	15120	4086	2043	1362	1022	817	681	584	511	454	409	371	341	314	292	272	255
	S	-	806	403	268	201	161	134	115	100	89	80	73	67	62	57	53	50
100	T	15120	5108	2554	1703	1277	1022	851	730	639	568	511	464	426	393	365	341	319
	S	-	1007	503	335	251	201	167	143	125	111	100	91	83	77	71	67	62
120	T	15120	6130	3065	2043	1532	1226	1022	876	766	681	613	557	511	472	438	409	383
	S	-	1209	604	403	302	241	201	172	151	134	120	109	100	93	86	80	75
140	T	15120	7151	3576	2384	1788	1430	1192	1022	894	795	715	650	596	550	511	477	447
	S	-	1411	705	470	352	282	235	201	176	156	141	128	117	108	100	94	88
160	T	15120	8173	4086	2724	2043	1635	1362	1168	1022	908	817	743	681	629	584	545	511
	S	-	1612	806	537	403	322	268	230	201	179	161	146	134	124	115	107	100
180	T	15120	9195	4597	3065	2299	1839	1532	1314	1149	1022	919	836	766	707	657	613	575
	S	-	1814	907	604	453	362	302	259	226	201	181	164	151	139	129	120	113
200	T	15120	10216	5108	3405	2554	2043	1703	1459	1277	1135	1022	929	851	786	730	681	639
	S	-	2015	1007	671	503	403	335	287	251	223	201	183	167	155	143	134	125
220	T	15120	11238	5619	3746	2809	2248	1873	1605	1405	1249	1124	1022	936	864	803	749	702
	S	-	2217	1108	739	554	443	369	316	277	246	221	201	184	170	158	147	138
240	T	15120	12259	6130	4086	3065	2452	2043	1751	1532	1362	1226	1114	1022	943	876	817	766
	S	-	2418	1209	806	604	483	403	345	302	268	241	219	201	186	172	161	151

TTM: Timber-Timber-Maximum | TTP: Timber-Timber-Partial | TCM: Timber-Concrete-Maximum | TCP: Timber-Concrete-Partial

T: $F_{1,T,Rk}$ load-carrying capacity of timber | S: $F_{1,S,Rk}$ load-carrying capacity of steel

Table B. 97 Angle bracket type 6504S13, Variant TTP, Fastener GH Screw 5x60, Density 350 kg/m³Characteristic load-carrying capacity $F_{T,Rk}$ (N) for one / two angle brackets

angle bracket		1													2
f (mm)		0	10	20	30	40	50	60	70	80	90	100	110	120	0
$F_{T,Rk}$	T	1589	1032	735	490	368	294	245	210	184	163	147	134	123	3178
	S	201	130	87	58	43	35	29	25	21	19	17	15	14	402

Characteristic load-carrying capacity $F_{2/3,Rk}$ (N) for one / two angle brackets

angle bracket		1	2
$F_{2/3,Rk}$	T	5220	10440
	S	-	-

Characteristic load-carrying capacity $F_{4,Rk}$ (N) for one angle bracket

e (mm)		0	20	40	60	80	100	120	140	160	180	200	220	240	260	280	300	320
$F_{4,Rk}$	T	13590	1470	735	490	338	231	176	142	119	102	90	80	72	66	60	56	52
	S	-	186	93	62	40	27	21	16	14	12	10	9	8	7	7	6	6

Characteristic load-carrying capacity $F_{5,Rk}$ (N) for one angle bracket

b / e (mm)		0	20	40	60	80	100	120	140	160	180	200	220	240	260	280	300	320
0	T	403	891	4704	3136	2352	1882	1568	1344	1176	1045	941	855	784	724	672	627	588
	S	48	106	596	397	298	238	198	170	149	132	119	108	99	91	85	79	74
20	T	403	891	4530	3020	2265	1812	1510	1294	1133	1007	906	824	755	697	647	604	566
	S	48	106	596	397	298	238	198	170	149	132	119	108	99	91	85	79	74
40	T	403	891	4998	3332	2499	1999	1666	1428	1250	1111	1000	909	833	769	714	666	625
	S	48	106	596	397	298	238	198	170	149	132	119	108	99	91	85	79	74
60	T	403	891	4998	3332	2499	1999	1666	1428	1250	1111	1000	909	833	769	714	666	625
	S	48	106	596	397	298	238	198	170	149	132	119	108	99	91	85	79	74
80	T	403	891	4998	3332	2499	1999	1666	1428	1250	1111	1000	909	833	769	714	666	625
	S	48	106	596	397	298	238	198	170	149	132	119	108	99	91	85	79	74
100	T	403	891	4998	3332	2499	1999	1666	1428	1250	1111	1000	909	833	769	714	666	625
	S	48	106	596	397	298	238	198	170	149	132	119	108	99	91	85	79	74
120	T	403	891	4998	3332	2499	1999	1666	1428	1250	1111	1000	909	833	769	714	666	625
	S	48	106	596	397	298	238	198	170	149	132	119	108	99	91	85	79	74
140	T	403	891	4998	3332	2499	1999	1666	1428	1250	1111	1000	909	833	769	714	666	625
	S	48	106	596	397	298	238	198	170	149	132	119	108	99	91	85	79	74
160	T	403	891	4998	3332	2499	1999	1666	1428	1250	1111	1000	909	833	769	714	666	625
	S	48	106	596	397	298	238	198	170	149	132	119	108	99	91	85	79	74
180	T	403	891	4998	3332	2499	1999	1666	1428	1250	1111	1000	909	833	769	714	666	625
	S	48	106	596	397	298	238	198	170	149	132	119	108	99	91	85	79	74
200	T	403	891	4998	3332	2499	1999	1666	1428	1250	1111	1000	909	833	769	714	666	625
	S	48	106	596	397	298	238	198	170	149	132	119	108	99	91	85	79	74
220	T	403	891	4998	3332	2499	1999	1666	1428	1250	1111	1000	909	833	769	714	666	625
	S	48	106	596	397	298	238	198	170	149	132	119	108	99	91	85	79	74
240	T	403	891	4998	3332	2499	1999	1666	1428	1250	1111	1000	909	833	769	714	666	625
	S	48	106	596	397	298	238	198	170	149	132	119	108	99	91	85	79	74

Characteristic load-carrying capacity $F_{4/5,Rk}$ (N) for two angle brackets

b / e (mm)		0	20	40	60	80	100	120	140	160	180	200	220	240	260	280	300	320
0	T	23519	23519	23519	23519	23519	23519	23519	23519	23519	23519	23519	23519	23519	23519	23519	23519	23519
	S	-	-	-	-	-	-	-	-	-	-	-	-	-	-	-	-	-
20	T	23519	1589	795	530	397	318	265	227	199	177	159	144	132	122	114	106	99
	S	-	201	100	67	50	40	33	28	25	22	20	18	16	15	14	13	12
40	T	23519	3178	1589	1059	795	636	530	454	397	353	318	289	265	244	227	212	199
	S	-	403	201	134	100	80	67	57	50	44	40	36	33	31	28	26	25
60	T	23519	4768	2384	1589	1192	954	795	681	596	530	477	433	397	367	341	318	298
	S	-	604	302	201	151	120	100	86	75	67	60	54	50	46	43	40	37
80	T	23519	6357	3178	2119	1589	1271	1059	908	795	706	636	578	530	489	454	424	397
	S	-	806	403	268	201	161	134	115	100	89	80	73	67	62	57	53	50
100	T	23519	7946	3973	2649	1986	1589	1324	1135	993	883	795	722	662	611	568	530	497
	S	-	1007	503	335	251	201	167	143	125	111	100	91	83	77	71	67	62
120	T	23519	9535	4768	3178	2384	1907	1589	1362	1192	1059	954	867	795	733	681	636	596
	S	-	1209	604	403	302	241	201	172	151	134	120	109	100	93	86	80	75
140	T	23519	11124	5562	3708	2781	2225	1854	1589	1391	1236	1112	1011	927	856	795	742	695
	S	-	1411	705	470	352	282	235	201	176	156	141	128	117	108	100	94	88
160	T	23519	12714	6357	4238	3178	2543	2119	1816	1589	1413	1271	1156	1059	978	908	848	795
	S	-	1612	806	537	403	322	268	230	201	179	161	146	134	124	115	107	100
180	T	23519	14303	7151	4768	3576	2861	2384	2043	1788	1589	1430	1300	1192	1100	1022	954	894
	S	-	1814	907	604	453	362	302	259	226	201	181	164	151	139	129	120	113
200	T	23519	15892	7946	5297	3973	3178	2649	2270	1986	1766	1589	1445	1324	1222	1135	1059	993
	S	-	2015	1007	671	503	403	335	287	251	223	201	183	167	155	143	134	125
220	T	23519	17481	8741	5827	4370	3496	2914	2497	2185	1942	1748	1589	1457	1345	1249	1165	1093
	S	-	2217	1108	739	554	443	369	316	277	246	221	201	184	170	158	147	138
240	T	23519	19070	9535	6357	4768	3814	3178	2724	2384	2119	1907	1734	1589	1467	1362	1271	1192
	S	-	2418	1209	806	604	483	403	345	302	268	241	219	201	186	172	161	151

TTM: Timber-Timber-Maximum | TTP: Timber-Timber-Partial | TCM: Timber-Concrete-Maximum | TCP: Timber-Concrete-Partial

T: $F_{T,Rk}$ load-carrying capacity of timber | S: $F_{S,Rk}$ load-carrying capacity of steel

Table B. 98 Angle bracket type 9003S, Variant TCM, Fastener GH Nail 4x40, Density 350 kg/m³Characteristic load-carrying capacity $F_{T,Rk}$ (N) for one / two angle brackets

angle bracket		1												2	
f (mm)		0	10	20	30	40	50	60	70	80	90	100	110	120	0
$F_{T,Rk}$	T	22680	8712	4356	2904	2178	1742	1452	1245	1089	968	871	792	726	45360
	S	66	57	50	44	40	36	33	30	28	26	25	23	22	132
k_t (-)		5,5	6,4	7,3	8,2	9,1	10,0	10,9	11,8	12,7	13,6	14,5	15,5	16,4	2,7

Characteristic load-carrying capacity $F_{2/3,Rk}$ (N) for one / two angle brackets

angle bracket		1	2
$F_{2/3,Rk}$	T	4490	8980
	S	-	-

Characteristic load-carrying capacity $F_{4,Rk}$ (N) for one angle bracket

e (mm)		0	20	40	60	80	100	120	140	160	180	200	220	240	260	280	300	320
$F_{4,Rk}$	T	-	-	-	108900	4188	2135	1433	1078	864	721	619	542	482	434	395	362	334
	S	-	200	100	66	50	40	33	28	25	22	20	18	16	15	14	13	12
k_t (-)		0,0	1,8	3,6	5,5	7,3	9,1	10,9	12,7	14,5	16,4	18,2	20,0	21,8	23,6	25,5	27,3	29,1

Characteristic load-carrying capacity $F_{5,Rk}$ (N) for one angle bracket

b / e (mm)		0	20	40	60	80	100	120	140	160	180	200	220	240	260	280	300	320
0	T	1472	2222	4538	2100	1575	1260	1050	900	788	700	630	573	525	485	450	420	394
	S	464	702	995	663	497	398	331	284	248	221	199	180	165	153	142	132	124
20	T	1472	2222	4538	2100	1575	1260	1050	900	788	700	630	573	525	485	450	420	394
	S	464	702	995	663	497	398	331	284	248	221	199	180	165	153	142	132	124
40	T	1472	2222	4538	2100	1575	1260	1050	900	788	700	630	573	525	485	450	420	394
	S	464	702	995	663	497	398	331	284	248	221	199	180	165	153	142	132	124
60	T	1472	2222	4538	2100	1575	1260	1050	900	788	700	630	573	525	485	450	420	394
	S	464	702	995	663	497	398	331	284	248	221	199	180	165	153	142	132	124
80	T	1472	2222	4538	2100	1575	1260	1050	900	788	700	630	573	525	485	450	420	394
	S	464	702	995	663	497	398	331	284	248	221	199	180	165	153	142	132	124
100	T	1472	2222	4538	2100	1575	1260	1050	900	788	700	630	573	525	485	450	420	394
	S	464	702	995	663	497	398	331	284	248	221	199	180	165	153	142	132	124
120	T	1472	2222	4538	2100	1575	1260	1050	900	788	700	630	573	525	485	450	420	394
	S	464	702	995	663	497	398	331	284	248	221	199	180	165	153	142	132	124
140	T	1472	2222	4538	2100	1575	1260	1050	900	788	700	630	573	525	485	450	420	394
	S	464	702	995	663	497	398	331	284	248	221	199	180	165	153	142	132	124
160	T	1472	2222	4538	2100	1575	1260	1050	900	788	700	630	573	525	485	450	420	394
	S	464	702	995	663	497	398	331	284	248	221	199	180	165	153	142	132	124
180	T	1472	2222	4538	2100	1575	1260	1050	900	788	700	630	573	525	485	450	420	394
	S	464	702	995	663	497	398	331	284	248	221	199	180	165	153	142	132	124
200	T	1472	2222	4538	2100	1575	1260	1050	900	788	700	630	573	525	485	450	420	394
	S	464	702	995	663	497	398	331	284	248	221	199	180	165	153	142	132	124
220	T	1472	2222	4538	2100	1575	1260	1050	900	788	700	630	573	525	485	450	420	394
	S	464	702	995	663	497	398	331	284	248	221	199	180	165	153	142	132	124
240	T	1472	2222	4538	2100	1575	1260	1050	900	788	700	630	573	525	485	450	420	394
	S	464	702	995	663	497	398	331	284	248	221	199	180	165	153	142	132	124
$k_t \times b$ (-)		0,0	8,1	16,3	24,4	32,6	40,7	48,9	57,0	65,2	73,3	81,5	89,6	97,8	105,9	114,1	122,2	130,4

Characteristic load-carrying capacity $F_{4/5,Rk}$ (N) for two angle brackets

b / e (mm)		0	20	40	60	80	100	120	140	160	180	200	220	240	260	280	300	320
0	T	21599	21599	21599	21599	21599	21599	21599	21599	21599	21599	21599	21599	21599	21599	21599	21599	21599
	S	-	-	-	-	-	-	-	-	-	-	-	-	-	-	-	-	-
20	T	21599	21600	11340	7560	5670	4536	3780	3240	2835	2520	2268	2062	1890	1745	1620	1512	1418
	S	-	66	33	22	16	13	11	9	8	7	6	6	5	5	4	4	4
40	T	21599	21600	21600	15120	11340	9072	7560	6480	5670	5040	4536	4124	3780	3489	3240	3024	2835
	S	-	133	66	44	33	26	22	19	16	14	13	12	11	10	9	8	8
60	T	21599	21600	21600	21600	17010	13608	11340	9720	8505	7560	6804	6185	5670	5234	4860	4536	4253
	S	-	200	100	66	50	40	33	28	25	22	20	18	16	15	14	13	12
80	T	21599	21600	21600	21600	21600	18144	15120	12960	11340	10080	9072	8247	7560	6978	6480	6048	5670
	S	-	267	133	89	66	53	44	38	33	29	26	24	22	20	19	17	16
100	T	21599	21600	21600	21600	21600	18900	16200	14175	12600	11340	10309	9450	8723	8100	7560	7088	6708
	S	-	334	167	111	83	66	55	47	41	37	33	30	27	25	23	22	20
120	T	21599	21600	21600	21600	21600	21600	19440	17010	15120	13608	12371	11340	10468	9720	9072	8505	8050
	S	-	401	200	133	100	80	66	57	50	44	40	36	33	30	28	26	25
140	T	21599	21600	21600	21600	21600	21600	21600	19845	17640	15876	14433	13230	12212	11340	10584	9923	9423
	S	-	468	234	156	117	93	78	66	58	52	46	42	39	36	33	31	29
160	T	21599	21600	21600	21600	21600	21600	21600	21600	20160	18144	16495	15120	13957	12960	12096	11340	10740
	S	-	535	267	178	133	107	89	76	66	59	53	48	44	41	38	35	33
180	T	21599	21600	21600	21600	21600	21600	21600	21600	21600	20412	18556	17010	15702	14580	13608	12758	12058
	S	-	602	301	200	150	120	100	86	75	66	60	54	50	46	43	40	37
200	T	21599	21600	21600	21600	21600	21600	21600	21600	21600	21600	20618	18900	17446	16200	15120	14175	13375
	S	-	669	334	223	167	133	111	95	83	74	66	60	55	51	47	44	41
220	T	21599	21600	21600	21600	21600	21600	21600	21600	21600	21600	21600	20790	19191	17820	16632	15593	14653
	S	-	736	368	245	184	147	122	105	92	81	73	66	61	56	52	49	46
240	T	21599	21600	21600	21600	21600	21600	21600	21600	21600	21600	21600	21600	20935	19440	18144	17010	16010
	S	-	803	401	267	200	160	133	114	100	89	80	73	66	61	57	53	50
$k_t \times b$ (-)		0,0	109,1	218,2	327,3	436,4	545,5	654,5	763,6	872,7	981,8	1090,9	1200,0	1309,1	1418,2	1527,3	1636,4	1745,5

TTM: Timber-Timber-Maximum | TTP: Timber-Timber-Partial | TCM: Timber-Concrete-Maximum | TCP: Timber-Concrete-Partial

T: $F_{T,Rk}$ load-carrying capacity of timber | S: $F_{S,Rk}$ load-carrying capacity of steel

Table B. 99 Angle bracket type 9003S, Variant TCM, Fastener GH Nail 4x60, Density 350 kg/m³Characteristic load-carrying capacity $F_{T,Rk}$ (N) for one / two angle brackets

angle bracket		1												2	
f (mm)		0	10	20	30	40	50	60	70	80	90	100	110	120	0
$F_{T,Rk}$	T	28368	14520	7260	4840	3630	2904	2420	2074	1815	1613	1452	1320	1210	56736
	S	66	57	50	44	40	36	33	30	28	26	25	23	22	132
k_t (-)		5,5	6,4	7,3	8,2	9,1	10,0	10,9	11,8	12,7	13,6	14,5	15,5	16,4	2,7

Characteristic load-carrying capacity $F_{2/3,Rk}$ (N) for one / two angle brackets

angle bracket		1	2
$F_{2/3,Rk}$	T	6550	13100
	S	-	-

Characteristic load-carrying capacity $F_{4,Rk}$ (N) for one angle bracket

e (mm)		0	20	40	60	80	100	120	140	160	180	200	220	240	260	280	300	320
$F_{4,Rk}$	T	-	-	-	181500	6981	3559	2388	1797	1440	1202	1031	903	803	723	658	603	557
	S	-	200	100	66	50	40	33	28	25	22	20	18	16	15	14	13	12
k_t (-)		0,0	1,8	3,6	5,5	7,3	9,1	10,9	12,7	14,5	16,4	18,2	20,0	21,8	23,6	25,5	27,3	29,1

Characteristic load-carrying capacity $F_{5,Rk}$ (N) for one angle bracket

b / e (mm)		0	20	40	60	80	100	120	140	160	180	200	220	240	260	280	300	320
0	T	2453	3704	7563	3500	2625	2100	1750	1500	1313	1167	1050	955	875	808	750	700	656
	S	464	702	995	663	497	398	331	284	248	221	199	180	165	153	142	132	124
20	T	2453	3704	7563	3500	2625	2100	1750	1500	1313	1167	1050	955	875	808	750	700	656
	S	464	702	995	663	497	398	331	284	248	221	199	180	165	153	142	132	124
40	T	2453	3704	7563	3500	2625	2100	1750	1500	1313	1167	1050	955	875	808	750	700	656
	S	464	702	995	663	497	398	331	284	248	221	199	180	165	153	142	132	124
60	T	2453	3704	7563	3500	2625	2100	1750	1500	1313	1167	1050	955	875	808	750	700	656
	S	464	702	995	663	497	398	331	284	248	221	199	180	165	153	142	132	124
80	T	2453	3704	7563	3500	2625	2100	1750	1500	1313	1167	1050	955	875	808	750	700	656
	S	464	702	995	663	497	398	331	284	248	221	199	180	165	153	142	132	124
100	T	2453	3704	7563	3500	2625	2100	1750	1500	1313	1167	1050	955	875	808	750	700	656
	S	464	702	995	663	497	398	331	284	248	221	199	180	165	153	142	132	124
120	T	2453	3704	7563	3500	2625	2100	1750	1500	1313	1167	1050	955	875	808	750	700	656
	S	464	702	995	663	497	398	331	284	248	221	199	180	165	153	142	132	124
140	T	2453	3704	7563	3500	2625	2100	1750	1500	1313	1167	1050	955	875	808	750	700	656
	S	464	702	995	663	497	398	331	284	248	221	199	180	165	153	142	132	124
160	T	2453	3704	7563	3500	2625	2100	1750	1500	1313	1167	1050	955	875	808	750	700	656
	S	464	702	995	663	497	398	331	284	248	221	199	180	165	153	142	132	124
180	T	2453	3704	7563	3500	2625	2100	1750	1500	1313	1167	1050	955	875	808	750	700	656
	S	464	702	995	663	497	398	331	284	248	221	199	180	165	153	142	132	124
200	T	2453	3704	7563	3500	2625	2100	1750	1500	1313	1167	1050	955	875	808	750	700	656
	S	464	702	995	663	497	398	331	284	248	221	199	180	165	153	142	132	124
220	T	2453	3704	7563	3500	2625	2100	1750	1500	1313	1167	1050	955	875	808	750	700	656
	S	464	702	995	663	497	398	331	284	248	221	199	180	165	153	142	132	124
240	T	2453	3704	7563	3500	2625	2100	1750	1500	1313	1167	1050	955	875	808	750	700	656
	S	464	702	995	663	497	398	331	284	248	221	199	180	165	153	142	132	124
$k_t \times b$ (-)		0,0	8,1	16,3	24,4	32,6	40,7	48,9	57,0	65,2	73,3	81,5	89,6	97,8	105,9	114,1	122,2	130,4

Characteristic load-carrying capacity $F_{4/5,Rk}$ (N) for two angle brackets

b / e (mm)		0	20	40	60	80	100	120	140	160	180	200	220	240	260	280	300	320
0	T	35999	35999	35999	35999	35999	35999	35999	35999	35999	35999	35999	35999	35999	35999	35999	35999	35999
	S	-	-	-	-	-	-	-	-	-	-	-	-	-	-	-	-	-
20	T	35999	28368	14184	9456	7092	5674	4728	4053	3546	3152	2837	2579	2364	2182	2026	1891	1773
	S	-	66	33	22	16	13	11	9	8	7	6	6	5	5	4	4	4
40	T	35999	36000	28368	18912	14184	11347	9456	8105	7092	6304	5674	5158	4728	4364	4053	3782	3546
	S	-	133	66	44	33	26	22	19	16	14	13	12	11	10	9	8	8
60	T	35999	36000	36000	28368	21276	17021	14184	12158	10638	9456	8510	7737	7092	6546	6079	5674	5319
	S	-	200	100	66	50	40	33	28	25	22	20	18	16	15	14	13	12
80	T	35999	36000	36000	36000	28368	22694	18912	16210	14184	12608	11347	10316	9456	8729	8105	7565	7092
	S	-	267	133	89	66	53	44	38	33	29	26	24	22	20	19	17	16
100	T	35999	36000	36000	36000	35460	28368	23640	20263	17730	15760	14184	12895	11820	10911	10131	9456	8865
	S	-	334	167	111	83	66	55	47	41	37	33	30	27	25	23	22	20
120	T	35999	36000	36000	36000	36000	34042	28368	24315	21276	18912	17021	15473	14184	13093	12158	11347	10638
	S	-	401	200	133	100	80	66	57	50	44	40	36	33	30	28	26	25
140	T	35999	36000	36000	36000	36000	33096	28368	24822	22064	19858	18052	16548	15275	14184	13238	12411	
	S	-	468	234	156	117	93	78	66	58	52	46	42	39	36	33	31	29
160	T	35999	36000	36000	36000	36000	36000	32421	28368	25216	22694	20631	18912	17457	16210	15130	14184	
	S	-	535	267	178	133	107	89	76	66	59	53	48	44	41	38	35	33
180	T	35999	36000	36000	36000	36000	36000	36000	36000	31914	28368	25531	23210	21276	19639	18237	17021	15957
	S	-	602	301	200	150	120	100	86	75	66	60	54	50	46	43	40	37
200	T	35999	36000	36000	36000	36000	36000	36000	36000	35460	31520	28368	25789	23640	21822	20263	18912	17730
	S	-	669	334	223	167	133	111	95	83	74	66	60	55	51	47	44	41
220	T	35999	36000	36000	36000	36000	36000	36000	36000	36000	34672	31205	28368	26004	24004	22289	20803	19503
	S	-	736	368	245	184	147	122	105	92	81	73	66	61	56	52	49	46
240	T	35999	36000	36000	36000	36000	36000	36000	36000	36000	36000	34042	30947	28368	26186	24315	22694	21276
	S	-	803	401	267	200	160	133	114	100	89	80	73	66	61	57	53	50
$k_t \times b$ (-)		0,0	109,1	218,2	327,3	436,4	545,5	654,5	763,6	872,7	981,8	1090,9	1200,0	1309,1	1418,2	1527,3	1636,4	1745,5

TTM: Timber-Timber-Maximum | TTP: Timber-Timber-Partial | TCM: Timber-Concrete-Maximum | TCP: Timber-Concrete-Partial

T: $F_{T,Rk}$ load-carrying capacity of timber | S: $F_{S,Rk}$ load-carrying capacity of steel

Table B. 100 Angle bracket type 9003S, Variant TCM, Fastener GH Screw 5x40, Density 350 kg/m³Characteristic load-carrying capacity $F_{1,Rk}$ (N) for one / two angle brackets

angle bracket		1												2	
f (mm)		0	10	20	30	40	50	60	70	80	90	100	110	120	0
$F_{1,Rk}$	T	24036	18295	9148	6098	4574	3659	3049	2614	2287	2033	1830	1663	1525	48072
	S	66	57	50	44	40	36	33	30	28	26	25	23	22	132
k_t (-)		5,5	6,4	7,3	8,2	9,1	10,0	10,9	11,8	12,7	13,6	14,5	15,5	16,4	2,7

Characteristic load-carrying capacity $F_{2/3,Rk}$ (N) for one / two angle brackets

angle bracket		1	2
$F_{2/3,Rk}$	T	6430	12860
	S	-	-

Characteristic load-carrying capacity $F_{4,Rk}$ (N) for one angle bracket

e (mm)		0	20	40	60	80	100	120	140	160	180	200	220	240	260	280	300	320
$F_{4,Rk}$	T	-	-	-	228690	8796	4484	3009	2264	1815	1515	1299	1138	1012	911	829	760	702
	S	-	200	100	66	50	40	33	28	25	22	20	18	16	15	14	13	12
k_t (-)		0,0	1,8	3,6	5,5	7,3	9,1	10,9	12,7	14,5	16,4	18,2	20,0	21,8	23,6	25,5	27,3	29,1

Characteristic load-carrying capacity $F_{5,Rk}$ (N) for one angle bracket

b / e (mm)		0	20	40	60	80	100	120	140	160	180	200	220	240	260	280	300	320
0	T	3090	4667	9529	4410	3308	2646	2205	1890	1654	1470	1323	1203	1103	1018	945	882	827
	S	464	702	995	663	497	398	331	284	248	221	199	180	165	153	142	132	124
20	T	3090	4667	9529	4410	3308	2646	2205	1890	1654	1470	1323	1203	1103	1018	945	882	827
	S	464	702	995	663	497	398	331	284	248	221	199	180	165	153	142	132	124
40	T	3090	4667	9529	4410	3308	2646	2205	1890	1654	1470	1323	1203	1103	1018	945	882	827
	S	464	702	995	663	497	398	331	284	248	221	199	180	165	153	142	132	124
60	T	3090	4667	9529	4410	3308	2646	2205	1890	1654	1470	1323	1203	1103	1018	945	882	827
	S	464	702	995	663	497	398	331	284	248	221	199	180	165	153	142	132	124
80	T	3090	4667	9529	4410	3308	2646	2205	1890	1654	1470	1323	1203	1103	1018	945	882	827
	S	464	702	995	663	497	398	331	284	248	221	199	180	165	153	142	132	124
100	T	3090	4667	9529	4410	3308	2646	2205	1890	1654	1470	1323	1203	1103	1018	945	882	827
	S	464	702	995	663	497	398	331	284	248	221	199	180	165	153	142	132	124
120	T	3090	4667	9529	4410	3308	2646	2205	1890	1654	1470	1323	1203	1103	1018	945	882	827
	S	464	702	995	663	497	398	331	284	248	221	199	180	165	153	142	132	124
140	T	3090	4667	9529	4410	3308	2646	2205	1890	1654	1470	1323	1203	1103	1018	945	882	827
	S	464	702	995	663	497	398	331	284	248	221	199	180	165	153	142	132	124
160	T	3090	4667	9529	4410	3308	2646	2205	1890	1654	1470	1323	1203	1103	1018	945	882	827
	S	464	702	995	663	497	398	331	284	248	221	199	180	165	153	142	132	124
180	T	3090	4667	9529	4410	3308	2646	2205	1890	1654	1470	1323	1203	1103	1018	945	882	827
	S	464	702	995	663	497	398	331	284	248	221	199	180	165	153	142	132	124
200	T	3090	4667	9529	4410	3308	2646	2205	1890	1654	1470	1323	1203	1103	1018	945	882	827
	S	464	702	995	663	497	398	331	284	248	221	199	180	165	153	142	132	124
220	T	3090	4667	9529	4410	3308	2646	2205	1890	1654	1470	1323	1203	1103	1018	945	882	827
	S	464	702	995	663	497	398	331	284	248	221	199	180	165	153	142	132	124
240	T	3090	4667	9529	4410	3308	2646	2205	1890	1654	1470	1323	1203	1103	1018	945	882	827
	S	464	702	995	663	497	398	331	284	248	221	199	180	165	153	142	132	124
$k_t \times b$ (-)		0,0	8,1	16,3	24,4	32,6	40,7	48,9	57,0	65,2	73,3	81,5	89,6	97,8	105,9	114,1	122,2	130,4

Characteristic load-carrying capacity $F_{4/5,Rk}$ (N) for two angle brackets

b / e (mm)		0	20	40	60	80	100	120	140	160	180	200	220	240	260	280	300	320
0	T	45360	45360	45360	45360	45360	45360	45360	45360	45360	45360	45360	45360	45360	45360	45360	45360	45360
	S	-	-	-	-	-	-	-	-	-	-	-	-	-	-	-	-	-
20	T	45360	24036	12018	8012	6009	4807	4006	3434	3005	2671	2404	2185	2003	1849	1717	1602	1502
	S	-	66	33	22	16	13	11	9	8	7	6	6	5	5	4	4	4
40	T	45360	45360	24036	16024	12018	9614	8012	6867	6009	5341	4807	4370	4006	3698	3434	3205	3005
	S	-	133	66	44	33	26	22	19	16	14	13	12	11	10	9	8	8
60	T	45360	45360	36054	24036	18027	14422	12018	10301	9014	8012	7211	6555	6009	5547	5151	4807	4507
	S	-	200	100	66	50	40	33	28	25	22	20	18	16	15	14	13	12
80	T	45360	45360	45360	32048	24036	19229	16024	13735	12018	10683	9614	8740	8012	7396	6867	6410	6009
	S	-	267	133	89	66	53	44	38	33	29	26	24	22	20	19	17	16
100	T	45360	45360	45360	40060	30045	24036	20030	17169	15023	13353	12018	10925	10015	9245	8584	8012	7511
	S	-	334	167	111	83	66	55	47	41	37	33	30	27	25	23	22	20
120	T	45360	45360	45360	45360	36054	28843	24036	20602	18027	16024	14422	13111	12018	11094	10301	9614	9014
	S	-	401	200	133	100	80	66	57	50	44	40	36	33	30	28	26	25
140	T	45360	45360	45360	45360	42063	33650	28042	24036	21032	18695	16825	15296	14021	12942	12018	11217	10516
	S	-	468	234	156	117	93	78	66	58	52	46	42	39	36	33	31	29
160	T	45360	45360	45360	45360	45360	38458	32048	27470	24036	21365	19229	17481	16024	14791	13735	12819	12018
	S	-	535	267	178	133	107	89	76	66	59	53	48	44	41	38	35	33
180	T	45360	45360	45360	45360	45360	43265	36054	30903	27041	24036	21632	19666	18027	16640	15452	14422	13520
	S	-	602	301	200	150	120	100	86	75	66	60	54	50	46	43	40	37
200	T	45360	45360	45360	45360	45360	45360	40060	34337	30045	26707	24036	21851	20030	18489	17169	16024	15023
	S	-	669	334	223	167	133	111	95	83	74	66	60	55	51	47	44	41
220	T	45360	45360	45360	45360	45360	45360	44066	37771	33050	29377	26440	24036	22033	20338	18885	17626	16525
	S	-	736	368	245	184	147	122	105	92	81	73	66	61	56	52	49	46
240	T	45360	45360	45360	45360	45360	45360	45360	41205	36054	32048	28843	26221	24036	22187	20602	19229	18027
	S	-	803	401	267	200	160	133	114	100	89	80	73	66	61	57	53	50
$k_t \times b$ (-)		0,0	109,1	218,2	327,3	436,4	545,5	654,5	763,6	872,7	981,8	1090,9	1200,0	1309,1	1418,2	1527,3	1636,4	1745,5

TTM: Timber-Timber-Maximum | TTP: Timber-Timber-Partial | TCM: Timber-Concrete-Maximum | TCP: Timber-Concrete-Partial

T: $F_{1,T,Rk}$ load-carrying capacity of timber | S: $F_{1,S,Rk}$ load-carrying capacity of steel

Table B. 101 Angle bracket type 9003S, Variant TCM, Fastener GH Screw 5x60, Density 350 kg/m³Characteristic load-carrying capacity $F_{1,Rk}$ (N) for one / two angle brackets

angle bracket		1												2	
f (mm)		0	10	20	30	40	50	60	70	80	90	100	110	120	0
$F_{1,Rk}$	T	27180	27180	14230	9486	7115	5692	4743	4066	3557	3162	2846	2587	2372	54360
	S	66	57	50	44	40	36	33	30	28	26	25	23	22	132
k_t (-)		5,5	6,4	7,3	8,2	9,1	10,0	10,9	11,8	12,7	13,6	14,5	15,5	16,4	2,7

Characteristic load-carrying capacity $F_{2/3,Rk}$ (N) for one / two angle brackets

angle bracket		1	2
$F_{2/3,Rk}$	T	7800	15600
	S	-	-

Characteristic load-carrying capacity $F_{4,Rk}$ (N) for one angle bracket

e (mm)		0	20	40	60	80	100	120	140	160	180	200	220	240	260	280	300	320
$F_{4,Rk}$	T	-	-	-	355740	13682	6975	4681	3522	2823	2356	2021	1770	1574	1417	1289	1182	1091
	S	-	200	100	66	50	40	33	28	25	22	20	18	16	15	14	13	12
k_t (-)		0,0	1,8	3,6	5,5	7,3	9,1	10,9	12,7	14,5	16,4	18,2	20,0	21,8	23,6	25,5	27,3	29,1

Characteristic load-carrying capacity $F_{5,Rk}$ (N) for one angle bracket

b / e (mm)		0	20	40	60	80	100	120	140	160	180	200	220	240	260	280	300	320
0	T	4807	7260	14823	6860	5145	4116	3430	2940	2573	2287	2058	1871	1715	1583	1470	1372	1286
	S	464	702	995	663	497	398	331	284	248	221	199	180	165	153	142	132	124
20	T	4807	7260	14823	6860	5145	4116	3430	2940	2573	2287	2058	1871	1715	1583	1470	1372	1286
	S	464	702	995	663	497	398	331	284	248	221	199	180	165	153	142	132	124
40	T	4807	7260	14823	6860	5145	4116	3430	2940	2573	2287	2058	1871	1715	1583	1470	1372	1286
	S	464	702	995	663	497	398	331	284	248	221	199	180	165	153	142	132	124
60	T	4807	7260	14823	6860	5145	4116	3430	2940	2573	2287	2058	1871	1715	1583	1470	1372	1286
	S	464	702	995	663	497	398	331	284	248	221	199	180	165	153	142	132	124
80	T	4807	7260	14823	6860	5145	4116	3430	2940	2573	2287	2058	1871	1715	1583	1470	1372	1286
	S	464	702	995	663	497	398	331	284	248	221	199	180	165	153	142	132	124
100	T	4807	7260	14823	6860	5145	4116	3430	2940	2573	2287	2058	1871	1715	1583	1470	1372	1286
	S	464	702	995	663	497	398	331	284	248	221	199	180	165	153	142	132	124
120	T	4807	7260	14823	6860	5145	4116	3430	2940	2573	2287	2058	1871	1715	1583	1470	1372	1286
	S	464	702	995	663	497	398	331	284	248	221	199	180	165	153	142	132	124
140	T	4807	7260	14823	6860	5145	4116	3430	2940	2573	2287	2058	1871	1715	1583	1470	1372	1286
	S	464	702	995	663	497	398	331	284	248	221	199	180	165	153	142	132	124
160	T	4807	7260	14823	6860	5145	4116	3430	2940	2573	2287	2058	1871	1715	1583	1470	1372	1286
	S	464	702	995	663	497	398	331	284	248	221	199	180	165	153	142	132	124
180	T	4807	7260	14823	6860	5145	4116	3430	2940	2573	2287	2058	1871	1715	1583	1470	1372	1286
	S	464	702	995	663	497	398	331	284	248	221	199	180	165	153	142	132	124
200	T	4807	7260	14823	6860	5145	4116	3430	2940	2573	2287	2058	1871	1715	1583	1470	1372	1286
	S	464	702	995	663	497	398	331	284	248	221	199	180	165	153	142	132	124
220	T	4807	7260	14823	6860	5145	4116	3430	2940	2573	2287	2058	1871	1715	1583	1470	1372	1286
	S	464	702	995	663	497	398	331	284	248	221	199	180	165	153	142	132	124
240	T	4807	7260	14823	6860	5145	4116	3430	2940	2573	2287	2058	1871	1715	1583	1470	1372	1286
	S	464	702	995	663	497	398	331	284	248	221	199	180	165	153	142	132	124
$k_t \times b$ (-)		0,0	8,1	16,3	24,4	32,6	40,7	48,9	57,0	65,2	73,3	81,5	89,6	97,8	105,9	114,1	122,2	130,4

Characteristic load-carrying capacity $F_{4/5,Rk}$ (N) for two angle brackets

b / e (mm)		0	20	40	60	80	100	120	140	160	180	200	220	240	260	280	300	320
0	T	70560	70560	70560	70560	70560	70560	70560	70560	70560	70560	70560	70560	70560	70560	70560	70560	70560
	S	-	-	-	-	-	-	-	-	-	-	-	-	-	-	-	-	-
20	T	70560	27180	13590	9060	6795	5436	4530	3883	3398	3020	2718	2471	2265	2091	1941	1812	1699
	S	-	66	33	22	16	13	11	9	8	7	6	6	5	5	4	4	4
40	T	70560	54360	27180	18120	13590	10872	9060	7766	6795	6040	5436	4942	4530	4182	3883	3624	3398
	S	-	133	66	44	33	26	22	19	16	14	13	12	11	10	9	8	8
60	T	70560	70560	40770	27180	20385	16308	13590	11649	10193	9060	8154	7413	6795	6272	5824	5436	5096
	S	-	200	100	66	50	40	33	28	25	22	20	18	16	15	14	13	12
80	T	70560	70560	54360	36240	27180	21744	18120	15531	13590	12080	10872	9884	9060	8363	7766	7248	6795
	S	-	267	133	89	66	53	44	38	33	29	26	24	22	20	19	17	16
100	T	70560	70560	67950	45300	33975	27180	22650	19414	16988	15100	13590	12355	11325	10454	9707	9060	8494
	S	-	334	167	111	83	66	55	47	41	37	33	30	27	25	23	22	20
120	T	70560	70560	70560	54360	40770	32616	27180	23297	20385	18120	16308	14825	13590	12545	11649	10872	10193
	S	-	401	200	133	100	80	66	57	50	44	40	36	33	30	28	26	25
140	T	70560	70560	70560	63420	47565	38052	31710	27180	23783	21140	19026	17296	15855	14635	13590	12684	11891
	S	-	468	234	156	117	93	78	66	58	52	46	42	39	36	33	31	29
160	T	70560	70560	70560	54360	43488	36240	31063	27180	24160	21744	19767	18120	16726	15531	14496	13590	
	S	-	535	267	178	133	107	89	76	66	59	53	48	44	41	38	35	33
180	T	70560	70560	70560	70560	61155	48924	40770	34946	30578	27180	24462	22238	20385	18817	17473	16308	15289
	S	-	602	301	200	150	120	100	86	75	66	60	54	50	46	43	40	37
200	T	70560	70560	70560	70560	67950	54360	45300	38829	33975	30200	27180	24709	22650	20908	19414	18120	16988
	S	-	669	334	223	167	133	111	95	83	74	66	60	55	51	47	44	41
220	T	70560	70560	70560	70560	70560	59796	49830	42711	37373	33220	29898	27180	24915	22998	21356	19932	18686
	S	-	736	368	245	184	147	122	105	92	81	73	66	61	56	52	49	46
240	T	70560	70560	70560	70560	70560	65232	54360	46594	40770	36240	32616	29651	27180	25089	23297	21744	20385
	S	-	803	401	267	200	160	133	114	100	89	80	73	66	61	57	53	50
$k_t \times b$ (-)		0,0	109,1	218,2	327,3	436,4	545,5	654,5	763,6	872,7	981,8	1090,9	1200,0	1309,1	1418,2	1527,3	1636,4	1745,5

TTM: Timber-Timber-Maximum | TTP: Timber-Timber-Partial | TCM: Timber-Concrete-Maximum | TCP: Timber-Concrete-Partial

T: $F_{1,T,Rk}$ load-carrying capacity of timber | S: $F_{1,S,Rk}$ load-carrying capacity of steel

Table B. 102 Angle bracket type 9003S, Variant TCP, Fastener GH Nail 4x40, Density 350 kg/m³Characteristic load-carrying capacity $F_{1,Rk}$ (N) for one / two angle brackets

angle bracket		1													2
f (mm)		0	10	20	30	40	50	60	70	80	90	100	110	120	0
$F_{1,Rk}$	T	15120	8712	4356	2904	2178	1742	1452	1245	1089	968	871	792	726	30240
	S	66	57	50	44	40	36	33	30	28	26	25	23	22	132
k_t (-)		5,5	6,4	7,3	8,2	9,1	10,0	10,9	11,8	12,7	13,6	14,5	15,5	16,4	2,7

Characteristic load-carrying capacity $F_{2/3,Rk}$ (N) for one / two angle brackets

angle bracket		1	2
$F_{2/3,Rk}$	T	3140	6280
	S	-	-

Characteristic load-carrying capacity $F_{4,Rk}$ (N) for one angle bracket

e (mm)		0	20	40	60	80	100	120	140	160	180	200	220	240	260	280	300	320
$F_{4,Rk}$	T	-	-	-	108900	4188	2135	1433	1078	864	721	619	542	482	434	395	362	334
	S	-	200	100	66	50	40	33	28	25	22	20	18	16	15	14	13	12
k_t (-)		0,0	1,8	3,6	5,5	7,3	9,1	10,9	12,7	14,5	16,4	18,2	20,0	21,8	23,6	25,5	27,3	29,1

Characteristic load-carrying capacity $F_{5,Rk}$ (N) for one angle bracket

b / e (mm)		0	20	40	60	80	100	120	140	160	180	200	220	240	260	280	300	320
0	T	1472	2222	4538	2100	1575	1260	1050	900	788	700	630	573	525	485	450	420	394
	S	464	702	995	663	497	398	331	284	248	221	199	180	165	153	142	132	124
20	T	1472	2222	4538	2100	1575	1260	1050	900	788	700	630	573	525	485	450	420	394
	S	464	702	995	663	497	398	331	284	248	221	199	180	165	153	142	132	124
40	T	1472	2222	4538	2100	1575	1260	1050	900	788	700	630	573	525	485	450	420	394
	S	464	702	995	663	497	398	331	284	248	221	199	180	165	153	142	132	124
60	T	1472	2222	4538	2100	1575	1260	1050	900	788	700	630	573	525	485	450	420	394
	S	464	702	995	663	497	398	331	284	248	221	199	180	165	153	142	132	124
80	T	1472	2222	4538	2100	1575	1260	1050	900	788	700	630	573	525	485	450	420	394
	S	464	702	995	663	497	398	331	284	248	221	199	180	165	153	142	132	124
100	T	1472	2222	4538	2100	1575	1260	1050	900	788	700	630	573	525	485	450	420	394
	S	464	702	995	663	497	398	331	284	248	221	199	180	165	153	142	132	124
120	T	1472	2222	4538	2100	1575	1260	1050	900	788	700	630	573	525	485	450	420	394
	S	464	702	995	663	497	398	331	284	248	221	199	180	165	153	142	132	124
140	T	1472	2222	4538	2100	1575	1260	1050	900	788	700	630	573	525	485	450	420	394
	S	464	702	995	663	497	398	331	284	248	221	199	180	165	153	142	132	124
160	T	1472	2222	4538	2100	1575	1260	1050	900	788	700	630	573	525	485	450	420	394
	S	464	702	995	663	497	398	331	284	248	221	199	180	165	153	142	132	124
180	T	1472	2222	4538	2100	1575	1260	1050	900	788	700	630	573	525	485	450	420	394
	S	464	702	995	663	497	398	331	284	248	221	199	180	165	153	142	132	124
200	T	1472	2222	4538	2100	1575	1260	1050	900	788	700	630	573	525	485	450	420	394
	S	464	702	995	663	497	398	331	284	248	221	199	180	165	153	142	132	124
220	T	1472	2222	4538	2100	1575	1260	1050	900	788	700	630	573	525	485	450	420	394
	S	464	702	995	663	497	398	331	284	248	221	199	180	165	153	142	132	124
240	T	1472	2222	4538	2100	1575	1260	1050	900	788	700	630	573	525	485	450	420	394
	S	464	702	995	663	497	398	331	284	248	221	199	180	165	153	142	132	124
$k_t \times b$ (-)		0,0	8,1	16,3	24,4	32,6	40,7	48,9	57,0	65,2	73,3	81,5	89,6	97,8	105,9	114,1	122,2	130,4

Characteristic load-carrying capacity $F_{4/5,Rk}$ (N) for two angle brackets

b / e (mm)		0	20	40	60	80	100	120	140	160	180	200	220	240	260	280	300	320
0	T	14400	14400	14400	14400	14400	14400	14400	14400	14400	14400	14400	14400	14400	14400	14400	14400	14400
	S	-	-	-	-	-	-	-	-	-	-	-	-	-	-	-	-	-
20	T	14400	14400	7560	5040	3780	3024	2520	2160	1890	1680	1512	1375	1260	1163	1080	1008	945
	S	-	66	33	22	16	13	11	9	8	7	6	6	5	5	4	4	4
40	T	14400	14400	14400	10080	7560	6048	5040	4320	3780	3360	3024	2749	2520	2326	2160	2016	1890
	S	-	133	66	44	33	26	22	19	16	14	13	12	11	10	9	8	8
60	T	14400	14400	14400	14400	11340	9072	7560	6480	5670	5040	4536	4124	3780	3489	3240	3024	2835
	S	-	200	100	66	50	40	33	28	25	22	20	18	16	15	14	13	12
80	T	14400	14400	14400	14400	14400	12096	10080	8640	7560	6720	6048	5498	5040	4652	4320	4032	3780
	S	-	267	133	89	66	53	44	38	33	29	26	24	22	20	19	17	16
100	T	14400	14400	14400	14400	14400	14400	12600	10800	9450	8400	7560	6873	6300	5815	5400	5040	4725
	S	-	334	167	111	83	66	55	47	41	37	33	30	27	25	23	22	20
120	T	14400	14400	14400	14400	14400	14400	14400	12960	11340	10080	9072	8247	7560	6978	6480	6048	5670
	S	-	401	200	133	100	80	66	57	50	44	40	36	33	30	28	26	25
140	T	14400	14400	14400	14400	14400	14400	14400	14400	13230	11760	10584	9622	8820	8142	7560	7056	6615
	S	-	468	234	156	117	93	78	66	58	52	46	42	39	36	33	31	29
160	T	14400	14400	14400	14400	14400	14400	14400	14400	14400	13440	12096	10996	10080	9305	8640	8064	7560
	S	-	535	267	178	133	107	89	76	66	59	53	48	44	41	38	35	33
180	T	14400	14400	14400	14400	14400	14400	14400	14400	14400	14400	13608	12371	11340	10468	9720	9072	8505
	S	-	602	301	200	150	120	100	86	75	66	60	54	50	46	43	40	37
200	T	14400	14400	14400	14400	14400	14400	14400	14400	14400	14400	14400	14400	13745	12600	11631	10800	10080
	S	-	669	334	223	167	133	111	95	83	74	66	60	55	51	47	44	41
220	T	14400	14400	14400	14400	14400	14400	14400	14400	14400	14400	14400	14400	14400	13860	12794	11880	11088
	S	-	736	368	245	184	147	122	105	92	81	73	66	61	56	52	49	46
240	T	14400	14400	14400	14400	14400	14400	14400	14400	14400	14400	14400	14400	14400	13957	12960	12096	11340
	S	-	803	401	267	200	160	133	114	100	89	80	73	66	61	57	53	50
$k_t \times b$ (-)		0,0	109,1	218,2	327,3	436,4	545,5	654,5	763,6	872,7	981,8	1090,9	1200,0	1309,1	1418,2	1527,3	1636,4	1745,5

TTM: Timber-Timber-Maximum | TTP: Timber-Timber-Partial | TCM: Timber-Concrete-Maximum | TCP: Timber-Concrete-Partial

T: $F_{1,T,Rk}$ load-carrying capacity of timber | S: $F_{1,S,Rk}$ load-carrying capacity of steel

Table B. 103 Angle bracket type 9003S, Variant TCP, Fastener GH Nail 4x60, Density 350 kg/m³Characteristic load-carrying capacity $F_{T,Rk}$ (N) for one / two angle brackets

angle bracket		1													2
f (mm)		0	10	20	30	40	50	60	70	80	90	100	110	120	0
$F_{T,Rk}$	T	18912	14520	7260	4840	3630	2904	2420	2074	1815	1613	1452	1320	1210	37824
	S	66	57	50	44	40	36	33	30	28	26	25	23	22	132
k_t (-)		5,5	6,4	7,3	8,2	9,1	10,0	10,9	11,8	12,7	13,6	14,5	15,5	16,4	2,7

Characteristic load-carrying capacity $F_{2/3,Rk}$ (N) for one / two angle brackets

angle bracket		1	2
$F_{2/3,Rk}$	T	4710	9420
	S	-	-

Characteristic load-carrying capacity $F_{4,Rk}$ (N) for one angle bracket

e (mm)		0	20	40	60	80	100	120	140	160	180	200	220	240	260	280	300	320
$F_{4,Rk}$	T	-	-	-	181500	6981	3559	2388	1797	1440	1202	1031	903	803	723	658	603	557
	S	-	200	100	66	50	40	33	28	25	22	20	18	16	15	14	13	12
k_t (-)		0,0	1,8	3,6	5,5	7,3	9,1	10,9	12,7	14,5	16,4	18,2	20,0	21,8	23,6	25,5	27,3	29,1

Characteristic load-carrying capacity $F_{5,Rk}$ (N) for one angle bracket

b / e (mm)		0	20	40	60	80	100	120	140	160	180	200	220	240	260	280	300	320
0	T	2453	3704	7563	3500	2625	2100	1750	1500	1313	1167	1050	955	875	808	750	700	656
	S	464	702	995	663	497	398	331	284	248	221	199	180	165	153	142	132	124
20	T	2453	3704	7563	3500	2625	2100	1750	1500	1313	1167	1050	955	875	808	750	700	656
	S	464	702	995	663	497	398	331	284	248	221	199	180	165	153	142	132	124
40	T	2453	3704	7563	3500	2625	2100	1750	1500	1313	1167	1050	955	875	808	750	700	656
	S	464	702	995	663	497	398	331	284	248	221	199	180	165	153	142	132	124
60	T	2453	3704	7563	3500	2625	2100	1750	1500	1313	1167	1050	955	875	808	750	700	656
	S	464	702	995	663	497	398	331	284	248	221	199	180	165	153	142	132	124
80	T	2453	3704	7563	3500	2625	2100	1750	1500	1313	1167	1050	955	875	808	750	700	656
	S	464	702	995	663	497	398	331	284	248	221	199	180	165	153	142	132	124
100	T	2453	3704	7563	3500	2625	2100	1750	1500	1313	1167	1050	955	875	808	750	700	656
	S	464	702	995	663	497	398	331	284	248	221	199	180	165	153	142	132	124
120	T	2453	3704	7563	3500	2625	2100	1750	1500	1313	1167	1050	955	875	808	750	700	656
	S	464	702	995	663	497	398	331	284	248	221	199	180	165	153	142	132	124
140	T	2453	3704	7563	3500	2625	2100	1750	1500	1313	1167	1050	955	875	808	750	700	656
	S	464	702	995	663	497	398	331	284	248	221	199	180	165	153	142	132	124
160	T	2453	3704	7563	3500	2625	2100	1750	1500	1313	1167	1050	955	875	808	750	700	656
	S	464	702	995	663	497	398	331	284	248	221	199	180	165	153	142	132	124
180	T	2453	3704	7563	3500	2625	2100	1750	1500	1313	1167	1050	955	875	808	750	700	656
	S	464	702	995	663	497	398	331	284	248	221	199	180	165	153	142	132	124
200	T	2453	3704	7563	3500	2625	2100	1750	1500	1313	1167	1050	955	875	808	750	700	656
	S	464	702	995	663	497	398	331	284	248	221	199	180	165	153	142	132	124
220	T	2453	3704	7563	3500	2625	2100	1750	1500	1313	1167	1050	955	875	808	750	700	656
	S	464	702	995	663	497	398	331	284	248	221	199	180	165	153	142	132	124
240	T	2453	3704	7563	3500	2625	2100	1750	1500	1313	1167	1050	955	875	808	750	700	656
	S	464	702	995	663	497	398	331	284	248	221	199	180	165	153	142	132	124
$k_t \times b$ (-)		0,0	8,1	16,3	24,4	32,6	40,7	48,9	57,0	65,2	73,3	81,5	89,6	97,8	105,9	114,1	122,2	130,4

Characteristic load-carrying capacity $F_{4/5,Rk}$ (N) for two angle brackets

b / e (mm)		0	20	40	60	80	100	120	140	160	180	200	220	240	260	280	300	320
0	T	23999	23999	23999	23999	23999	23999	23999	23999	23999	23999	23999	23999	23999	23999	23999	23999	23999
	S	-	-	-	-	-	-	-	-	-	-	-	-	-	-	-	-	-
20	T	23999	18912	9456	6304	4728	3782	3152	2702	2364	2101	1891	1719	1576	1455	1351	1261	1182
	S	-	66	33	22	16	13	11	9	8	7	6	6	5	5	4	4	4
40	T	23999	24000	18912	12608	9456	7565	6304	5403	4728	4203	3782	3439	3152	2910	2702	2522	2364
	S	-	133	66	44	33	26	22	19	16	14	13	12	11	10	9	8	8
60	T	23999	24000	24000	18912	14184	11347	9456	8105	7092	6304	5674	5158	4728	4364	4053	3782	3546
	S	-	200	100	66	50	40	33	28	25	22	20	18	16	15	14	13	12
80	T	23999	24000	24000	24000	18912	15130	12608	10807	9456	8405	7565	6877	6304	5819	5403	5043	4728
	S	-	267	133	89	66	53	44	38	33	29	26	24	22	20	19	17	16
100	T	23999	24000	24000	24000	23640	18912	15760	13509	11820	10507	9456	8596	7880	7274	6754	6304	5910
	S	-	334	167	111	83	66	55	47	41	37	33	30	27	25	23	22	20
120	T	23999	24000	24000	24000	24000	22694	18912	16210	14184	12608	11347	10316	9456	8729	8105	7565	7092
	S	-	401	200	133	100	80	66	57	50	44	40	36	33	30	28	26	25
140	T	23999	24000	24000	24000	24000	22064	18912	16548	14709	13238	12035	11032	10183	9456	8826	8274	
	S	-	468	234	156	117	93	78	66	58	52	46	42	39	36	33	31	29
160	T	23999	24000	24000	24000	24000	24000	21614	18912	16811	15130	13754	12608	11638	10807	10086	9456	
	S	-	535	267	178	133	107	89	76	66	59	53	48	44	41	38	35	33
180	T	23999	24000	24000	24000	24000	24000	24000	21276	18912	17021	15473	14184	13093	12158	11347	10638	
	S	-	602	301	200	150	120	100	86	75	66	60	54	50	46	43	40	37
200	T	23999	24000	24000	24000	24000	24000	24000	23640	21013	18912	17193	15760	14548	13509	12608	11820	
	S	-	669	334	223	167	133	111	95	83	74	66	60	55	51	47	44	41
220	T	23999	24000	24000	24000	24000	24000	24000	24000	23115	20803	18912	17336	16002	14859	13869	13002	
	S	-	736	368	245	184	147	122	105	92	81	73	66	61	56	52	49	46
240	T	23999	24000	24000	24000	24000	24000	24000	24000	24000	24000	22694	20631	18912	17457	16210	15130	14184
	S	-	803	401	267	200	160	133	114	100	89	80	73	66	61	57	53	50
$k_t \times b$ (-)		0,0	109,1	218,2	327,3	436,4	545,5	654,5	763,6	872,7	981,8	1090,9	1200,0	1309,1	1418,2	1527,3	1636,4	1745,5

TTM: Timber-Timber-Maximum | TTP: Timber-Timber-Partial | TCM: Timber-Concrete-Maximum | TCP: Timber-Concrete-Partial

T: $F_{T,Rk}$ load-carrying capacity of timber | S: $F_{S,Rk}$ load-carrying capacity of steel

Table B. 104 Angle bracket type 9003S, Variant TCP, Fastener GH Screw 5x40, Density 350 kg/m³Characteristic load-carrying capacity $F_{1,Rk}$ (N) for one / two angle brackets

angle bracket	1													2	
f (mm)	0	10	20	30	40	50	60	70	80	90	100	110	120	0	
$F_{1,Rk}$	T	16024	16024	9148	6098	4574	3659	3049	2614	2287	2033	1830	1663	1525	32048
	S	66	57	50	44	40	36	33	30	28	26	25	23	22	132
k_t (-)	5,5	6,4	7,3	8,2	9,1	10,0	10,9	11,8	12,7	13,6	14,5	15,5	16,4	2,7	

Characteristic load-carrying capacity $F_{2/3,Rk}$ (N) for one / two angle brackets

angle bracket	1	2	
$F_{2/3,Rk}$	T	4790	9580
	S	-	-

Characteristic load-carrying capacity $F_{4,Rk}$ (N) for one angle bracket

e (mm)	0	20	40	60	80	100	120	140	160	180	200	220	240	260	280	300	320	
$F_{4,Rk}$	T	-	-	-	228690	8796	4484	3009	2264	1815	1515	1299	1138	1012	911	829	760	702
	S	-	200	100	66	50	40	33	28	25	22	20	18	16	15	14	13	12
k_t (-)	0,0	1,8	3,6	5,5	7,3	9,1	10,9	12,7	14,5	16,4	18,2	20,0	21,8	23,6	25,5	27,3	29,1	

Characteristic load-carrying capacity $F_{5,Rk}$ (N) for one angle bracket

b / e (mm)	0	20	40	60	80	100	120	140	160	180	200	220	240	260	280	300	320	
0	T	3090	4667	9529	4410	3308	2646	2205	1890	1654	1470	1323	1203	1103	1018	945	882	827
	S	464	702	995	663	497	398	331	284	248	221	199	180	165	153	142	132	124
20	T	3090	4667	9529	4410	3308	2646	2205	1890	1654	1470	1323	1203	1103	1018	945	882	827
	S	464	702	995	663	497	398	331	284	248	221	199	180	165	153	142	132	124
40	T	3090	4667	9529	4410	3308	2646	2205	1890	1654	1470	1323	1203	1103	1018	945	882	827
	S	464	702	995	663	497	398	331	284	248	221	199	180	165	153	142	132	124
60	T	3090	4667	9529	4410	3308	2646	2205	1890	1654	1470	1323	1203	1103	1018	945	882	827
	S	464	702	995	663	497	398	331	284	248	221	199	180	165	153	142	132	124
80	T	3090	4667	9529	4410	3308	2646	2205	1890	1654	1470	1323	1203	1103	1018	945	882	827
	S	464	702	995	663	497	398	331	284	248	221	199	180	165	153	142	132	124
100	T	3090	4667	9529	4410	3308	2646	2205	1890	1654	1470	1323	1203	1103	1018	945	882	827
	S	464	702	995	663	497	398	331	284	248	221	199	180	165	153	142	132	124
120	T	3090	4667	9529	4410	3308	2646	2205	1890	1654	1470	1323	1203	1103	1018	945	882	827
	S	464	702	995	663	497	398	331	284	248	221	199	180	165	153	142	132	124
140	T	3090	4667	9529	4410	3308	2646	2205	1890	1654	1470	1323	1203	1103	1018	945	882	827
	S	464	702	995	663	497	398	331	284	248	221	199	180	165	153	142	132	124
160	T	3090	4667	9529	4410	3308	2646	2205	1890	1654	1470	1323	1203	1103	1018	945	882	827
	S	464	702	995	663	497	398	331	284	248	221	199	180	165	153	142	132	124
180	T	3090	4667	9529	4410	3308	2646	2205	1890	1654	1470	1323	1203	1103	1018	945	882	827
	S	464	702	995	663	497	398	331	284	248	221	199	180	165	153	142	132	124
200	T	3090	4667	9529	4410	3308	2646	2205	1890	1654	1470	1323	1203	1103	1018	945	882	827
	S	464	702	995	663	497	398	331	284	248	221	199	180	165	153	142	132	124
220	T	3090	4667	9529	4410	3308	2646	2205	1890	1654	1470	1323	1203	1103	1018	945	882	827
	S	464	702	995	663	497	398	331	284	248	221	199	180	165	153	142	132	124
240	T	3090	4667	9529	4410	3308	2646	2205	1890	1654	1470	1323	1203	1103	1018	945	882	827
	S	464	702	995	663	497	398	331	284	248	221	199	180	165	153	142	132	124
$k_t \times b$ (-)	0,0	8,1	16,3	24,4	32,6	40,7	48,9	57,0	65,2	73,3	81,5	89,6	97,8	105,9	114,1	122,2	130,4	

Characteristic load-carrying capacity $F_{4/5,Rk}$ (N) for two angle brackets

b / e (mm)	0	20	40	60	80	100	120	140	160	180	200	220	240	260	280	300	320	
0	T	30239	30239	30239	30239	30239	30239	30239	30239	30239	30239	30239	30239	30239	30239	30239	30239	
	S	-	-	-	-	-	-	-	-	-	-	-	-	-	-	-	-	
20	T	30239	16024	8012	5341	4006	3205	2671	2289	2003	1780	1602	1457	1335	1233	1145	1068	1002
	S	-	66	33	22	16	13	11	9	8	7	6	6	5	5	4	4	4
40	T	30239	30240	16024	10683	8012	6410	5341	4578	4006	3561	3205	2913	2671	2465	2289	2137	2003
	S	-	133	66	44	33	26	22	19	16	14	13	12	11	10	9	8	8
60	T	30239	30240	24036	16024	12018	9614	8012	6867	6009	5341	4807	4370	4006	3698	3434	3205	3005
	S	-	200	100	66	50	40	33	28	25	22	20	18	16	15	14	13	12
80	T	30239	30240	30240	21365	16024	12819	10683	9157	8012	7122	6410	5827	5341	4930	4578	4273	4006
	S	-	267	133	89	66	53	44	38	33	29	26	24	22	20	19	17	16
100	T	30239	30240	30240	26707	20030	16024	13353	11446	10015	8902	8012	7284	6677	6163	5723	5341	5008
	S	-	334	167	111	83	66	55	47	41	37	33	30	27	25	23	22	20
120	T	30239	30240	30240	30240	24036	19229	16024	13735	12018	10683	9614	8740	8012	7396	6867	6410	6009
	S	-	401	200	133	100	80	66	57	50	44	40	36	33	30	28	26	25
140	T	30239	30240	30240	30240	28042	22434	18695	16024	14021	12463	11217	10197	9347	8628	8012	7478	7011
	S	-	468	234	156	117	93	78	66	58	52	46	42	39	36	33	31	29
160	T	30239	30240	30240	30240	30240	25638	21365	18313	16024	14244	12819	11654	10683	9861	9157	8546	8012
	S	-	535	267	178	133	107	89	76	66	59	53	48	44	41	38	35	33
180	T	30239	30240	30240	30240	30240	28843	24036	20602	18027	16024	14422	13111	12018	11094	10301	9614	9014
	S	-	602	301	200	150	120	100	86	75	66	60	54	50	46	43	40	37
200	T	30239	30240	30240	30240	30240	26707	22891	20030	17804	16024	14567	13353	12326	11446	10683	10015	
	S	-	669	334	223	167	133	111	95	83	74	66	60	55	51	47	44	41
220	T	30239	30240	30240	30240	30240	29377	25181	22033	19585	17626	16024	14689	13559	12590	11751	11017	
	S	-	736	368	245	184	147	122	105	92	81	73	66	61	56	52	49	46
240	T	30239	30240	30240	30240	30240	30240	27470	24036	21365	19229	17481	16024	14791	13735	12819	12018	
	S	-	803	401	267	200	160	133	114	100	89	80	73	66	61	57	53	50
$k_t \times b$ (-)	0,0	109,1	218,2	327,3	436,4	545,5	654,5	763,6	872,7	981,8	1090,9	1200,0	1309,1	1418,2	1527,3	1636,4	1745,5	

TTM: Timber-Timber-Maximum | TTP: Timber-Timber-Partial | TCM: Timber-Concrete-Maximum | TCP: Timber-Concrete-Partial

T: $F_{1,T,Rk}$ load-carrying capacity of timber | S: $F_{1,S,Rk}$ load-carrying capacity of steel

Table B. 105 Angle bracket type 9003S, Variant TCP, Fastener GH Screw 5x60, Density 350 kg/m³Characteristic load-carrying capacity $F_{1,Rk}$ (N) for one / two angle brackets

angle bracket		1												2	
f (mm)		0	10	20	30	40	50	60	70	80	90	100	110	120	0
$F_{1,Rk}$	T	18120	18120	14230	9486	7115	5692	4743	4066	3557	3162	2846	2587	2372	36240
	S	66	57	50	44	40	36	33	30	28	26	25	23	22	132
k_t (-)		5,5	6,4	7,3	8,2	9,1	10,0	10,9	11,8	12,7	13,6	14,5	15,5	16,4	2,7

Characteristic load-carrying capacity $F_{2/3,Rk}$ (N) for one / two angle brackets

angle bracket		1	2
$F_{2/3,Rk}$	T	5960	11920
	S	-	-

Characteristic load-carrying capacity $F_{4,Rk}$ (N) for one angle bracket

e (mm)		0	20	40	60	80	100	120	140	160	180	200	220	240	260	280	300	320
$F_{4,Rk}$	T	-	-	-	355740	13682	6975	4681	3522	2823	2356	2021	1770	1574	1417	1289	1182	1091
	S	-	200	100	66	50	40	33	28	25	22	20	18	16	15	14	13	12
k_t (-)		0,0	1,8	3,6	5,5	7,3	9,1	10,9	12,7	14,5	16,4	18,2	20,0	21,8	23,6	25,5	27,3	29,1

Characteristic load-carrying capacity $F_{5,Rk}$ (N) for one angle bracket

b / e (mm)		0	20	40	60	80	100	120	140	160	180	200	220	240	260	280	300	320
0	T	4807	7260	14823	6860	5145	4116	3430	2940	2573	2287	2058	1871	1715	1583	1470	1372	1286
	S	464	702	995	663	497	398	331	284	248	221	199	180	165	153	142	132	124
20	T	4807	7260	14823	6040	4530	3624	3020	2589	2265	2013	1812	1647	1510	1394	1294	1208	1133
	S	464	702	995	663	497	398	331	284	248	221	199	180	165	153	142	132	124
40	T	4807	7260	14823	6860	5145	4116	3430	2940	2573	2287	2058	1871	1715	1583	1470	1372	1286
	S	464	702	995	663	497	398	331	284	248	221	199	180	165	153	142	132	124
60	T	4807	7260	14823	6860	5145	4116	3430	2940	2573	2287	2058	1871	1715	1583	1470	1372	1286
	S	464	702	995	663	497	398	331	284	248	221	199	180	165	153	142	132	124
80	T	4807	7260	14823	6860	5145	4116	3430	2940	2573	2287	2058	1871	1715	1583	1470	1372	1286
	S	464	702	995	663	497	398	331	284	248	221	199	180	165	153	142	132	124
100	T	4807	7260	14823	6860	5145	4116	3430	2940	2573	2287	2058	1871	1715	1583	1470	1372	1286
	S	464	702	995	663	497	398	331	284	248	221	199	180	165	153	142	132	124
120	T	4807	7260	14823	6860	5145	4116	3430	2940	2573	2287	2058	1871	1715	1583	1470	1372	1286
	S	464	702	995	663	497	398	331	284	248	221	199	180	165	153	142	132	124
140	T	4807	7260	14823	6860	5145	4116	3430	2940	2573	2287	2058	1871	1715	1583	1470	1372	1286
	S	464	702	995	663	497	398	331	284	248	221	199	180	165	153	142	132	124
160	T	4807	7260	14823	6860	5145	4116	3430	2940	2573	2287	2058	1871	1715	1583	1470	1372	1286
	S	464	702	995	663	497	398	331	284	248	221	199	180	165	153	142	132	124
180	T	4807	7260	14823	6860	5145	4116	3430	2940	2573	2287	2058	1871	1715	1583	1470	1372	1286
	S	464	702	995	663	497	398	331	284	248	221	199	180	165	153	142	132	124
200	T	4807	7260	14823	6860	5145	4116	3430	2940	2573	2287	2058	1871	1715	1583	1470	1372	1286
	S	464	702	995	663	497	398	331	284	248	221	199	180	165	153	142	132	124
220	T	4807	7260	14823	6860	5145	4116	3430	2940	2573	2287	2058	1871	1715	1583	1470	1372	1286
	S	464	702	995	663	497	398	331	284	248	221	199	180	165	153	142	132	124
240	T	4807	7260	14823	6860	5145	4116	3430	2940	2573	2287	2058	1871	1715	1583	1470	1372	1286
	S	464	702	995	663	497	398	331	284	248	221	199	180	165	153	142	132	124
$k_t \times b$ (-)		0,0	8,1	16,3	24,4	32,6	40,7	48,9	57,0	65,2	73,3	81,5	89,6	97,8	105,9	114,1	122,2	130,4

Characteristic load-carrying capacity $F_{4/5,Rk}$ (N) for two angle brackets

b / e (mm)		0	20	40	60	80	100	120	140	160	180	200	220	240	260	280	300	320
0	T	47040	47040	47040	47040	47040	47040	47040	47040	47040	47040	47040	47040	47040	47040	47040	47040	47040
	S	-	-	-	-	-	-	-	-	-	-	-	-	-	-	-	-	-
20	T	47040	18120	9060	6040	4530	3624	3020	2589	2265	2013	1812	1647	1510	1394	1294	1208	1133
	S	-	66	33	22	16	13	11	9	8	7	6	6	5	5	4	4	4
40	T	47040	36240	18120	12080	9060	7248	6040	5177	4530	4027	3624	3295	3020	2788	2589	2416	2265
	S	-	133	66	44	33	26	22	19	16	14	13	12	11	10	9	8	8
60	T	47040	47040	27180	18120	13590	10872	9060	7766	6795	6040	5436	4942	4530	4182	3883	3624	3398
	S	-	200	100	66	50	40	33	28	25	22	20	18	16	15	14	13	12
80	T	47040	47040	36240	24160	18120	14496	12080	10354	9060	8053	7248	6589	6040	5575	5177	4832	4530
	S	-	267	133	89	66	53	44	38	33	29	26	24	22	20	19	17	16
100	T	47040	47040	45300	30200	22650	18120	15100	12943	11325	10067	9060	8236	7550	6969	6471	6040	5663
	S	-	334	167	111	83	66	55	47	41	37	33	30	27	25	23	22	20
120	T	47040	47040	47040	36240	27180	21744	18120	15531	13590	12080	10872	9884	9060	8363	7766	7248	6795
	S	-	401	200	133	100	80	66	57	50	44	40	36	33	30	28	26	25
140	T	47040	47040	47040	42280	31710	25368	21140	18120	15855	14093	12684	11531	10570	9757	9060	8456	7928
	S	-	468	234	156	117	93	78	66	58	52	46	42	39	36	33	31	29
160	T	47040	47040	47040	47040	36240	28992	24160	20709	18120	16107	14496	13178	12080	11151	10354	9664	9060
	S	-	535	267	178	133	107	89	76	66	59	53	48	44	41	38	35	33
180	T	47040	47040	47040	47040	40770	32616	27180	23297	20385	18120	16308	14825	13590	12545	11649	10872	10193
	S	-	602	301	200	150	120	100	86	75	66	60	54	50	46	43	40	37
200	T	47040	47040	47040	47040	45300	36240	30200	25886	22650	20133	18120	16473	15100	13938	12943	12080	11325
	S	-	669	334	223	167	133	111	95	83	74	66	60	55	51	47	44	41
220	T	47040	47040	47040	47040	47040	39864	33220	28474	24915	22147	19932	18120	16610	15332	14237	13288	12458
	S	-	736	368	245	184	147	122	105	92	81	73	66	61	56	52	49	46
240	T	47040	47040	47040	47040	47040	43488	36240	31063	27180	24160	21744	19767	18120	16726	15531	14496	13590
	S	-	803	401	267	200	160	133	114	100	89	80	73	66	61	57	53	50
$k_t \times b$ (-)		0,0	109,1	218,2	327,3	436,4	545,5	654,5	763,6	872,7	981,8	1090,9	1200,0	1309,1	1418,2	1527,3	1636,4	1745,5

TTM: Timber-Timber-Maximum | TTP: Timber-Timber-Partial | TCM: Timber-Concrete-Maximum | TCP: Timber-Concrete-Partial

T: $F_{1,T,Rk}$ load-carrying capacity of timber | S: $F_{1,S,Rk}$ load-carrying capacity of steel

Table B. 106 Angle bracket type 9003S, Variant TTM, Fastener GH Nail 4x40, Density 350 kg/m³Characteristic load-carrying capacity $F_{T,Rk}$ (N) for one / two angle brackets

angle bracket		1													2
f (mm)		0	10	20	30	40	50	60	70	80	90	100	110	120	0
$F_{T,Rk}$	T	2427	2077	1814	1611	1449	1316	1206	1112	1032	963	871	792	726	4855
	S	738	632	552	490	440	400	366	338	314	293	274	250	229	1476

Characteristic load-carrying capacity $F_{2/3,Rk}$ (N) for one / two angle brackets

angle bracket		1	2
$F_{2/3,Rk}$	T	8690	17380
	S	-	-

Characteristic load-carrying capacity $F_{4,Rk}$ (N) for one angle bracket

e (mm)		0	20	40	60	80	100	120	140	160	180	200	220	240	260	280	300	320
$F_{4,Rk}$	T	26459	7185	3593	2395	1796	1437	1198	1026	864	721	619	542	482	434	395	362	334
	S	-	1990	995	663	497	398	331	284	248	221	195	171	152	137	124	114	105

Characteristic load-carrying capacity $F_{5,Rk}$ (N) for one angle bracket

b / e (mm)		0	20	40	60	80	100	120	140	160	180	200	220	240	260	280	300	320
0	T	1472	2222	3544	2100	1575	1260	1050	900	788	700	630	573	525	485	450	420	394
	S	464	702	995	663	497	398	331	284	248	221	199	180	165	153	142	132	124
20	T	1472	2222	4538	2100	1575	1260	1050	900	788	700	630	573	525	485	450	420	394
	S	464	702	995	663	497	398	331	284	248	221	199	180	165	153	142	132	124
40	T	1472	2222	4538	2100	1575	1260	1050	900	788	700	630	573	525	485	450	420	394
	S	464	702	995	663	497	398	331	284	248	221	199	180	165	153	142	132	124
60	T	1472	2222	4538	2100	1575	1260	1050	900	788	700	630	573	525	485	450	420	394
	S	464	702	995	663	497	398	331	284	248	221	199	180	165	153	142	132	124
80	T	1472	2222	4538	2100	1575	1260	1050	900	788	700	630	573	525	485	450	420	394
	S	464	702	995	663	497	398	331	284	248	221	199	180	165	153	142	132	124
100	T	1472	2222	4538	2100	1575	1260	1050	900	788	700	630	573	525	485	450	420	394
	S	464	702	995	663	497	398	331	284	248	221	199	180	165	153	142	132	124
120	T	1472	2222	4538	2100	1575	1260	1050	900	788	700	630	573	525	485	450	420	394
	S	464	702	995	663	497	398	331	284	248	221	199	180	165	153	142	132	124
140	T	1472	2222	4538	2100	1575	1260	1050	900	788	700	630	573	525	485	450	420	394
	S	464	702	995	663	497	398	331	284	248	221	199	180	165	153	142	132	124
160	T	1472	2222	4538	2100	1575	1260	1050	900	788	700	630	573	525	485	450	420	394
	S	464	702	995	663	497	398	331	284	248	221	199	180	165	153	142	132	124
180	T	1472	2222	4538	2100	1575	1260	1050	900	788	700	630	573	525	485	450	420	394
	S	464	702	995	663	497	398	331	284	248	221	199	180	165	153	142	132	124
200	T	1472	2222	4538	2100	1575	1260	1050	900	788	700	630	573	525	485	450	420	394
	S	464	702	995	663	497	398	331	284	248	221	199	180	165	153	142	132	124
220	T	1472	2222	4538	2100	1575	1260	1050	900	788	700	630	573	525	485	450	420	394
	S	464	702	995	663	497	398	331	284	248	221	199	180	165	153	142	132	124
240	T	1472	2222	4538	2100	1575	1260	1050	900	788	700	630	573	525	485	450	420	394
	S	464	702	995	663	497	398	331	284	248	221	199	180	165	153	142	132	124

Characteristic load-carrying capacity $F_{4/5,Rk}$ (N) for two angle brackets

b / e (mm)		0	20	40	60	80	100	120	140	160	180	200	220	240	260	280	300	320
0	T	21599	21599	21599	21599	21599	21599	21599	21599	21599	21599	21599	21599	21599	21599	21599	21599	21599
	S	-	-	-	-	-	-	-	-	-	-	-	-	-	-	-	-	-
20	T	21599	2427	1214	809	607	485	405	347	303	270	243	221	202	187	173	162	152
	S	-	738	369	246	184	147	123	105	92	82	73	67	61	56	52	49	46
40	T	21599	4855	2427	1618	1214	971	809	694	607	539	485	441	405	373	347	324	303
	S	-	1477	738	492	369	295	246	211	184	164	147	134	123	113	105	98	92
60	T	21599	7282	3641	2427	1821	1456	1214	1040	910	809	728	662	607	560	520	485	455
	S	-	2216	1108	738	554	443	369	316	277	246	221	201	184	170	158	147	138
80	T	21599	9709	4855	3236	2427	1942	1618	1387	1214	1079	971	883	809	747	694	647	607
	S	-	2955	1477	985	738	591	492	422	369	328	295	268	246	227	211	197	184
100	T	21599	12137	6068	4046	3034	2427	2023	1734	1517	1349	1214	1103	1011	934	867	809	759
	S	-	3694	1847	1231	923	738	615	527	461	410	369	335	307	284	263	246	230
120	T	21599	14564	7282	4855	3641	2913	2427	2081	1821	1618	1456	1324	1214	1120	1040	971	910
	S	-	4433	2216	1477	1108	886	738	633	554	492	443	403	369	341	316	295	277
140	T	21599	16992	8496	5664	4248	3398	2832	2427	2124	1888	1699	1545	1416	1307	1214	1133	1062
	S	-	5172	2586	1724	1293	1034	862	738	646	574	517	470	431	397	369	344	323
160	T	21599	19419	9709	6473	4855	3884	3236	2774	2427	2158	1942	1765	1618	1494	1387	1295	1214
	S	-	5911	2955	1970	1477	1182	985	844	738	656	591	537	492	454	422	394	369
180	T	21599	21600	10923	7282	5462	4369	3641	3121	2731	2427	2185	1986	1821	1680	1560	1456	1365
	S	-	6649	3324	2216	1662	1329	1108	949	831	738	664	604	554	511	474	443	415
200	T	21599	21600	12137	8091	6068	4855	4046	3468	3034	2697	2427	2207	2023	1867	1734	1618	1517
	S	-	7388	3694	2462	1847	1477	1231	1055	923	820	738	671	615	568	527	492	461
220	T	21599	21600	13351	8900	6675	5340	4450	3814	3338	2967	2670	2427	2225	2054	1907	1780	1669
	S	-	8127	4063	2709	2031	1625	1354	1161	1015	903	812	738	677	625	580	541	507
240	T	21599	21600	14564	9709	7282	5826	4855	4161	3641	3236	2913	2648	2427	2241	2081	1942	1821
	S	-	8866	4433	2955	2216	1773	1477	1266	1108	985	886	806	738	682	633	591	554

TTM: Timber-Timber-Maximum | TTP: Timber-Timber-Partial | TCM: Timber-Concrete-Maximum | TCP: Timber-Concrete-Partial

T: $F_{T,Rk}$ load-carrying capacity of timber | S: $F_{S,Rk}$ load-carrying capacity of steel

Table B. 107 Angle bracket type 9003S, Variant TTM, Fastener GH Nail 4x60, Density 350 kg/m³Characteristic load-carrying capacity $F_{T,Rk}$ (N) for one / two angle brackets

angle bracket		1													2
f (mm)		0	10	20	30	40	50	60	70	80	90	100	110	120	0
$F_{T,Rk}$	T	4046	3461	3024	2685	2414	2193	2009	1854	1721	1605	1452	1320	1210	8091
	S	738	632	552	490	440	400	366	338	314	293	274	250	229	1476

Characteristic load-carrying capacity $F_{2/3,Rk}$ (N) for one / two angle brackets

angle bracket		1	2
$F_{2/3,Rk}$	T	11100	22200
	S	-	-

Characteristic load-carrying capacity $F_{4,Rk}$ (N) for one angle bracket

e (mm)		0	20	40	60	80	100	120	140	160	180	200	220	240	260	280	300	320
$F_{4,Rk}$	T	33095	11975	5988	3992	2994	2395	1996	1711	1440	1202	1031	903	803	723	658	603	557
	S	-	1990	995	663	497	398	331	284	248	221	195	171	152	137	124	114	105

Characteristic load-carrying capacity $F_{5,Rk}$ (N) for one angle bracket

b / e (mm)		0	20	40	60	80	100	120	140	160	180	200	220	240	260	280	300	320
0	T	2453	3704	5906	3500	2625	2100	1750	1500	1313	1167	1050	955	875	808	750	700	656
	S	464	702	995	663	497	398	331	284	248	221	199	180	165	153	142	132	124
20	T	2453	3704	5906	3500	2625	2100	1750	1500	1313	1167	1050	955	875	808	750	700	656
	S	464	702	995	663	497	398	331	284	248	221	199	180	165	153	142	132	124
40	T	2453	3704	5906	3500	2625	2100	1750	1500	1313	1167	1050	955	875	808	750	700	656
	S	464	702	995	663	497	398	331	284	248	221	199	180	165	153	142	132	124
60	T	2453	3704	5906	3500	2625	2100	1750	1500	1313	1167	1050	955	875	808	750	700	656
	S	464	702	995	663	497	398	331	284	248	221	199	180	165	153	142	132	124
80	T	2453	3704	5906	3500	2625	2100	1750	1500	1313	1167	1050	955	875	808	750	700	656
	S	464	702	995	663	497	398	331	284	248	221	199	180	165	153	142	132	124
100	T	2453	3704	5906	3500	2625	2100	1750	1500	1313	1167	1050	955	875	808	750	700	656
	S	464	702	995	663	497	398	331	284	248	221	199	180	165	153	142	132	124
120	T	2453	3704	5906	3500	2625	2100	1750	1500	1313	1167	1050	955	875	808	750	700	656
	S	464	702	995	663	497	398	331	284	248	221	199	180	165	153	142	132	124
140	T	2453	3704	5906	3500	2625	2100	1750	1500	1313	1167	1050	955	875	808	750	700	656
	S	464	702	995	663	497	398	331	284	248	221	199	180	165	153	142	132	124
160	T	2453	3704	5906	3500	2625	2100	1750	1500	1313	1167	1050	955	875	808	750	700	656
	S	464	702	995	663	497	398	331	284	248	221	199	180	165	153	142	132	124
180	T	2453	3704	5906	3500	2625	2100	1750	1500	1313	1167	1050	955	875	808	750	700	656
	S	464	702	995	663	497	398	331	284	248	221	199	180	165	153	142	132	124
200	T	2453	3704	5906	3500	2625	2100	1750	1500	1313	1167	1050	955	875	808	750	700	656
	S	464	702	995	663	497	398	331	284	248	221	199	180	165	153	142	132	124
220	T	2453	3704	5906	3500	2625	2100	1750	1500	1313	1167	1050	955	875	808	750	700	656
	S	464	702	995	663	497	398	331	284	248	221	199	180	165	153	142	132	124
240	T	2453	3704	5906	3500	2625	2100	1750	1500	1313	1167	1050	955	875	808	750	700	656
	S	464	702	995	663	497	398	331	284	248	221	199	180	165	153	142	132	124

Characteristic load-carrying capacity $F_{4/5,Rk}$ (N) for two angle brackets

b / e (mm)		0	20	40	60	80	100	120	140	160	180	200	220	240	260	280	300	320
0	T	35999	35999	35999	35999	35999	35999	35999	35999	35999	35999	35999	35999	35999	35999	35999	35999	35999
	S	-	-	-	-	-	-	-	-	-	-	-	-	-	-	-	-	-
20	T	35999	4046	2023	1349	1011	809	674	578	506	450	405	368	337	311	289	270	253
	S	-	738	369	246	184	147	123	105	92	82	73	67	61	56	52	49	46
40	T	35999	8091	4046	2697	2023	1618	1349	1156	1011	899	809	736	674	622	578	539	506
	S	-	1477	738	492	369	295	246	211	184	164	147	134	123	113	105	98	92
60	T	35999	12137	6068	4046	3034	2427	2023	1734	1517	1349	1214	1103	1011	934	867	809	759
	S	-	2216	1108	738	554	443	369	316	277	246	221	201	184	170	158	147	138
80	T	35999	16182	8091	5394	4046	3236	2697	2312	2023	1798	1618	1471	1349	1245	1156	1079	1011
	S	-	2955	1477	985	738	591	492	422	369	328	295	268	246	227	211	197	184
100	T	35999	20228	10114	6743	5057	4046	3371	2890	2529	2248	2023	1839	1686	1556	1445	1349	1264
	S	-	3694	1847	1231	923	738	615	527	461	410	369	335	307	284	263	246	230
120	T	35999	24274	12137	8091	6068	4855	4046	3468	3034	2697	2427	2207	2023	1867	1734	1618	1517
	S	-	4433	2216	1477	1108	886	738	633	554	492	443	403	369	341	316	295	277
140	T	35999	28319	14160	9440	7080	5664	4720	4046	3540	3147	2832	2574	2360	2178	2023	1888	1770
	S	-	5172	2586	1724	1293	1034	862	738	646	574	517	470	431	397	369	344	323
160	T	35999	32365	16182	10788	8091	6473	5394	4624	4046	3596	3236	2942	2697	2490	2312	2158	2023
	S	-	5911	2955	1970	1477	1182	985	844	738	656	591	537	492	454	422	394	369
180	T	35999	36000	18205	12137	9103	7282	6068	5201	4551	4046	3641	3310	3034	2801	2601	2427	2276
	S	-	6649	3324	2216	1662	1329	1108	949	831	738	664	604	554	511	474	443	415
200	T	35999	36000	20228	13485	10114	8091	6743	5779	5057	4495	4046	3678	3371	3112	2890	2697	2529
	S	-	7388	3694	2462	1847	1477	1231	1055	923	820	738	671	615	568	527	492	461
220	T	35999	36000	22251	14834	11125	8900	7417	6357	5563	4945	4450	4046	3708	3423	3179	2967	2781
	S	-	8127	4063	2709	2031	1625	1354	1161	1015	903	812	738	677	625	580	541	507
240	T	35999	36000	24274	16182	12137	9709	8091	6935	6068	5394	4855	4413	4046	3734	3468	3236	3034
	S	-	8866	4433	2955	2216	1773	1477	1266	1108	985	886	806	738	682	633	591	554

TTM: Timber-Timber-Maximum | TTP: Timber-Timber-Partial | TCM: Timber-Concrete-Maximum | TCP: Timber-Concrete-Partial

T: $F_{T,Rk}$ load-carrying capacity of timber | S: $F_{S,Rk}$ load-carrying capacity of steel

Table B. 108 Angle bracket type 9003S, Variant TTM, Fastener GH Screw 5x40, Density 350 kg/m³Characteristic load-carrying capacity $F_{1,Rk}$ (N) for one / two angle brackets

angle bracket		1													2
f (mm)		0	10	20	30	40	50	60	70	80	90	100	110	120	0
$F_{1,Rk}$	T	5097	4361	3810	3383	3042	2763	2532	2336	2168	2023	1830	1663	1525	10195
	S	738	632	552	490	440	400	366	338	314	293	274	250	229	1476

Characteristic load-carrying capacity $F_{2/3,Rk}$ (N) for one / two angle brackets

angle bracket		1	2
$F_{2/3,Rk}$	T	9610	19220
	S	-	-

Characteristic load-carrying capacity $F_{4,Rk}$ (N) for one angle bracket

e (mm)		0	20	40	60	80	100	120	140	160	180	200	220	240	260	280	300	320
$F_{4,Rk}$	T	28041	15089	7544	5030	3772	3018	2515	2156	1815	1515	1299	1138	1012	911	829	760	702
	S	-	1990	995	663	497	398	331	284	248	221	195	171	152	137	124	114	105

Characteristic load-carrying capacity $F_{5,Rk}$ (N) for one angle bracket

b / e (mm)		0	20	40	60	80	100	120	140	160	180	200	220	240	260	280	300	320
0	T	3090	4667	7442	4410	3308	2646	2205	1890	1654	1470	1323	1203	1103	1018	945	882	827
	S	464	702	995	663	497	398	331	284	248	221	199	180	165	153	142	132	124
20	T	3090	4667	9529	4410	3308	2646	2205	1890	1654	1470	1323	1203	1103	1018	945	882	827
	S	464	702	995	663	497	398	331	284	248	221	199	180	165	153	142	132	124
40	T	3090	4667	9529	4410	3308	2646	2205	1890	1654	1470	1323	1203	1103	1018	945	882	827
	S	464	702	995	663	497	398	331	284	248	221	199	180	165	153	142	132	124
60	T	3090	4667	9529	4410	3308	2646	2205	1890	1654	1470	1323	1203	1103	1018	945	882	827
	S	464	702	995	663	497	398	331	284	248	221	199	180	165	153	142	132	124
80	T	3090	4667	9529	4410	3308	2646	2205	1890	1654	1470	1323	1203	1103	1018	945	882	827
	S	464	702	995	663	497	398	331	284	248	221	199	180	165	153	142	132	124
100	T	3090	4667	9529	4410	3308	2646	2205	1890	1654	1470	1323	1203	1103	1018	945	882	827
	S	464	702	995	663	497	398	331	284	248	221	199	180	165	153	142	132	124
120	T	3090	4667	9529	4410	3308	2646	2205	1890	1654	1470	1323	1203	1103	1018	945	882	827
	S	464	702	995	663	497	398	331	284	248	221	199	180	165	153	142	132	124
140	T	3090	4667	9529	4410	3308	2646	2205	1890	1654	1470	1323	1203	1103	1018	945	882	827
	S	464	702	995	663	497	398	331	284	248	221	199	180	165	153	142	132	124
160	T	3090	4667	9529	4410	3308	2646	2205	1890	1654	1470	1323	1203	1103	1018	945	882	827
	S	464	702	995	663	497	398	331	284	248	221	199	180	165	153	142	132	124
180	T	3090	4667	9529	4410	3308	2646	2205	1890	1654	1470	1323	1203	1103	1018	945	882	827
	S	464	702	995	663	497	398	331	284	248	221	199	180	165	153	142	132	124
200	T	3090	4667	9529	4410	3308	2646	2205	1890	1654	1470	1323	1203	1103	1018	945	882	827
	S	464	702	995	663	497	398	331	284	248	221	199	180	165	153	142	132	124
220	T	3090	4667	9529	4410	3308	2646	2205	1890	1654	1470	1323	1203	1103	1018	945	882	827
	S	464	702	995	663	497	398	331	284	248	221	199	180	165	153	142	132	124
240	T	3090	4667	9529	4410	3308	2646	2205	1890	1654	1470	1323	1203	1103	1018	945	882	827
	S	464	702	995	663	497	398	331	284	248	221	199	180	165	153	142	132	124

Characteristic load-carrying capacity $F_{4/5,Rk}$ (N) for two angle brackets

b / e (mm)		0	20	40	60	80	100	120	140	160	180	200	220	240	260	280	300	320
0	T	45360	45360	45360	45360	45360	45360	45360	45360	45360	45360	45360	45360	45360	45360	45360	45360	45360
	S	-	-	-	-	-	-	-	-	-	-	-	-	-	-	-	-	-
20	T	45360	5097	2549	1699	1274	1019	850	728	637	566	510	463	425	392	364	340	319
	S	-	738	369	246	184	147	123	105	92	82	73	67	61	56	52	49	46
40	T	45360	10195	5097	3398	2549	2039	1699	1456	1274	1133	1019	927	850	784	728	680	637
	S	-	1477	738	492	369	295	246	211	184	164	147	134	123	113	105	98	92
60	T	45360	15292	7646	5097	3823	3058	2549	2185	1912	1699	1529	1390	1274	1176	1092	1019	956
	S	-	2216	1108	738	554	443	369	316	277	246	221	201	184	170	158	147	138
80	T	45360	20390	10195	6797	5097	4078	3398	2913	2549	2266	2039	1854	1699	1568	1456	1359	1274
	S	-	2955	1477	985	738	591	492	422	369	328	295	268	246	227	211	197	184
100	T	45360	25487	12744	8496	6372	5097	4248	3641	3186	2832	2549	2317	2124	1961	1821	1699	1593
	S	-	3694	1847	1231	923	738	615	527	461	410	369	335	307	284	263	246	230
120	T	45360	30585	15292	10195	7646	6117	5097	4369	3823	3398	3058	2780	2549	2353	2185	2039	1912
	S	-	4433	2216	1477	1108	886	738	633	554	492	443	403	369	341	316	295	277
140	T	45360	35682	17841	11894	8921	7136	5947	5097	4460	3965	3568	3244	2974	2745	2549	2379	2230
	S	-	5172	2586	1724	1293	1034	862	738	646	574	517	470	431	397	369	344	323
160	T	45360	40780	20390	13593	10195	8156	6797	5826	5097	4531	4078	3707	3398	3137	2913	2719	2549
	S	-	5911	2955	1970	1477	1182	985	844	738	656	591	537	492	454	422	394	369
180	T	45360	45360	22939	15292	11469	9175	7646	6554	5735	5097	4588	4171	3823	3529	3277	3058	2867
	S	-	6649	3324	2216	1662	1329	1108	949	831	738	664	604	554	511	474	443	415
200	T	45360	45360	25487	16992	12744	10195	8496	7282	6372	5664	5097	4634	4248	3921	3641	3398	3186
	S	-	7388	3694	2462	1847	1477	1231	1055	923	820	738	671	615	568	527	492	461
220	T	45360	45360	28036	18691	14018	11214	9345	8010	7009	6230	5607	5097	4673	4313	4005	3738	3505
	S	-	8127	4063	2709	2031	1625	1354	1161	1015	903	812	738	677	625	580	541	507
240	T	45360	45360	30585	20390	15292	12234	10195	8739	7646	6797	6117	5561	5097	4705	4369	4078	3823
	S	-	8866	4433	2955	2216	1773	1477	1266	1108	985	886	806	738	682	633	591	554

TTM: Timber-Timber-Maximum | TTP: Timber-Timber-Partial | TCM: Timber-Concrete-Maximum | TCP: Timber-Concrete-Partial

T: $F_{1,T,Rk}$ load-carrying capacity of timber | S: $F_{1,S,Rk}$ load-carrying capacity of steel

Table B. 109 Angle bracket type 9003S, Variant TTM, Fastener GH Screw 5x60, Density 350 kg/m³Characteristic load-carrying capacity $F_{T,Rk}$ (N) for one / two angle brackets

angle bracket		1													2
f (mm)		0	10	20	30	40	50	60	70	80	90	100	110	120	0
$F_{T,Rk}$	T	7929	6784	5927	5263	4732	4299	3938	3633	3372	3146	2846	2587	2372	15859
	S	738	632	552	490	440	400	366	338	314	293	274	250	229	1476

Characteristic load-carrying capacity $F_{2/3,Rk}$ (N) for one / two angle brackets

angle bracket		1	2
$F_{2/3,Rk}$	T	10990	21980
	S	-	-

Characteristic load-carrying capacity $F_{4,Rk}$ (N) for one angle bracket

e (mm)		0	20	40	60	80	100	120	140	160	180	200	220	240	260	280	300	320
$F_{4,Rk}$	T	31709	23471	11736	7824	5868	4694	3912	3353	2823	2356	2021	1770	1574	1417	1289	1182	1091
	S	-	1990	995	663	497	398	331	284	248	221	195	171	152	137	124	114	105

Characteristic load-carrying capacity $F_{5,Rk}$ (N) for one angle bracket

b / e (mm)		0	20	40	60	80	100	120	140	160	180	200	220	240	260	280	300	320
0	T	4807	7260	11576	6860	5145	4116	3430	2940	2573	2287	2058	1871	1715	1583	1470	1372	1286
	S	464	702	995	663	497	398	331	284	248	221	199	180	165	153	142	132	124
20	T	4807	7260	14823	6860	5145	4116	3430	2940	2573	2287	2058	1871	1715	1583	1470	1372	1286
	S	464	702	995	663	497	398	331	284	248	221	199	180	165	153	142	132	124
40	T	4807	7260	14823	6860	5145	4116	3430	2940	2573	2287	2058	1871	1715	1583	1470	1372	1286
	S	464	702	995	663	497	398	331	284	248	221	199	180	165	153	142	132	124
60	T	4807	7260	14823	6860	5145	4116	3430	2940	2573	2287	2058	1871	1715	1583	1470	1372	1286
	S	464	702	995	663	497	398	331	284	248	221	199	180	165	153	142	132	124
80	T	4807	7260	14823	6860	5145	4116	3430	2940	2573	2287	2058	1871	1715	1583	1470	1372	1286
	S	464	702	995	663	497	398	331	284	248	221	199	180	165	153	142	132	124
100	T	4807	7260	14823	6860	5145	4116	3430	2940	2573	2287	2058	1871	1715	1583	1470	1372	1286
	S	464	702	995	663	497	398	331	284	248	221	199	180	165	153	142	132	124
120	T	4807	7260	14823	6860	5145	4116	3430	2940	2573	2287	2058	1871	1715	1583	1470	1372	1286
	S	464	702	995	663	497	398	331	284	248	221	199	180	165	153	142	132	124
140	T	4807	7260	14823	6860	5145	4116	3430	2940	2573	2287	2058	1871	1715	1583	1470	1372	1286
	S	464	702	995	663	497	398	331	284	248	221	199	180	165	153	142	132	124
160	T	4807	7260	14823	6860	5145	4116	3430	2940	2573	2287	2058	1871	1715	1583	1470	1372	1286
	S	464	702	995	663	497	398	331	284	248	221	199	180	165	153	142	132	124
180	T	4807	7260	14823	6860	5145	4116	3430	2940	2573	2287	2058	1871	1715	1583	1470	1372	1286
	S	464	702	995	663	497	398	331	284	248	221	199	180	165	153	142	132	124
200	T	4807	7260	14823	6860	5145	4116	3430	2940	2573	2287	2058	1871	1715	1583	1470	1372	1286
	S	464	702	995	663	497	398	331	284	248	221	199	180	165	153	142	132	124
220	T	4807	7260	14823	6860	5145	4116	3430	2940	2573	2287	2058	1871	1715	1583	1470	1372	1286
	S	464	702	995	663	497	398	331	284	248	221	199	180	165	153	142	132	124
240	T	4807	7260	14823	6860	5145	4116	3430	2940	2573	2287	2058	1871	1715	1583	1470	1372	1286
	S	464	702	995	663	497	398	331	284	248	221	199	180	165	153	142	132	124

Characteristic load-carrying capacity $F_{4/5,Rk}$ (N) for two angle brackets

b / e (mm)		0	20	40	60	80	100	120	140	160	180	200	220	240	260	280	300	320
0	T	63420	63420	63420	63420	63420	63420	63420	63420	63420	63420	63420	63420	63420	63420	63420	63420	63420
	S	-	-	-	-	-	-	-	-	-	-	-	-	-	-	-	-	-
20	T	63420	7929	3965	2643	1982	1586	1322	1133	991	881	793	721	661	610	566	529	496
	S	-	738	369	246	184	147	123	105	92	82	73	67	61	56	52	49	46
40	T	63420	15859	7929	5286	3965	3172	2643	2266	1982	1762	1586	1442	1322	1220	1133	1057	991
	S	-	1477	738	492	369	295	246	211	184	164	147	134	123	113	105	98	92
60	T	63420	23788	11894	7929	5947	4758	3965	3398	2974	2643	2379	2163	1982	1830	1699	1586	1487
	S	-	2216	1108	738	554	443	369	316	277	246	221	201	184	170	158	147	138
80	T	63420	31718	15859	10573	7929	6344	5286	4531	3965	3524	3172	2883	2643	2440	2266	2115	1982
	S	-	2955	1477	985	738	591	492	422	369	328	295	268	246	227	211	197	184
100	T	63420	39647	19823	13216	9912	7929	6608	5664	4956	4405	3965	3604	3304	3050	2832	2643	2478
	S	-	3694	1847	1231	923	738	615	527	461	410	369	335	307	284	263	246	230
120	T	63420	47576	23788	15859	11894	9515	7929	6797	5947	5286	4758	4325	3965	3660	3398	3172	2974
	S	-	4433	2216	1477	1108	886	738	633	554	492	443	403	369	341	316	295	277
140	T	63420	55506	27753	18502	13876	11101	9251	7929	6938	6167	5551	5046	4625	4270	3965	3700	3469
	S	-	5172	2586	1724	1293	1034	862	738	646	574	517	470	431	397	369	344	323
160	T	63420	63420	31718	21145	15859	12687	10573	9062	7929	7048	6344	5767	5286	4880	4531	4229	3965
	S	-	5911	2955	1970	1477	1182	985	844	738	656	591	537	492	454	422	394	369
180	T	63420	63420	35682	23788	17841	14273	11894	10195	8921	7929	7136	6488	5947	5490	5097	4758	4460
	S	-	6649	3324	2216	1662	1329	1108	949	831	738	664	604	554	511	474	443	415
200	T	63420	63420	39647	26431	19823	15859	13216	11328	9912	8810	7929	7209	6608	6100	5664	5286	4956
	S	-	7388	3694	2462	1847	1477	1231	1055	923	820	738	671	615	568	527	492	461
220	T	63420	63420	43612	29074	21806	17445	14537	12460	10903	9691	8722	7929	7269	6709	6230	5815	5451
	S	-	8127	4063	2709	2031	1625	1354	1161	1015	903	812	738	677	625	580	541	507
240	T	63420	63420	47576	31718	23788	19031	15859	13593	11894	10573	9515	8650	7929	7319	6797	6344	5947
	S	-	8866	4433	2955	2216	1773	1477	1266	1108	985	886	806	738	682	633	591	554

TTM: Timber-Timber-Maximum | TTP: Timber-Timber-Partial | TCM: Timber-Concrete-Maximum | TCP: Timber-Concrete-Partial

T: $F_{T,Rk}$ load-carrying capacity of timber | S: $F_{S,Rk}$ load-carrying capacity of steel

Table B. 110 Angle bracket type 9003S, Variant TTP, Fastener GH Nail 4x40, Density 350 kg/m³Characteristic load-carrying capacity $F_{1,Rk}$ (N) for one / two angle brackets

angle bracket		1													2
f (mm)		0	10	20	30	40	50	60	70	80	90	100	110	120	0
$F_{1,Rk}$	T	1848	1581	1381	1226	1103	1002	918	847	786	733	687	646	610	3695
	S	906	775	677	601	540	491	450	393	344	305	275	250	229	1812

Characteristic load-carrying capacity $F_{2/3,Rk}$ (N) for one / two angle brackets

angle bracket		1	2
$F_{2/3,Rk}$	T	5410	10820
	S	-	-

Characteristic load-carrying capacity $F_{4,Rk}$ (N) for one angle bracket

e (mm)		0	20	40	60	80	100	120	140	160	180	200	220	240	260	280	300	320
$F_{4,Rk}$	T	11340	5469	2735	1823	1367	1094	912	781	684	608	547	497	456	421	391	362	334
	S	-	1990	995	663	497	398	331	284	248	221	195	171	152	137	124	114	105

Characteristic load-carrying capacity $F_{5,Rk}$ (N) for one angle bracket

b / e (mm)		0	20	40	60	80	100	120	140	160	180	200	220	240	260	280	300	320
0	T	1472	2222	1969	1313	984	788	656	563	492	438	394	358	328	303	281	263	246
	S	464	702	995	663	497	398	331	284	248	221	199	180	165	153	142	132	124
20	T	1472	2222	3626	2100	1575	1260	1050	900	788	700	630	573	525	485	450	420	394
	S	464	702	995	663	497	398	331	284	248	221	199	180	165	153	142	132	124
40	T	1472	2222	4538	2100	1575	1260	1050	900	788	700	630	573	525	485	450	420	394
	S	464	702	995	663	497	398	331	284	248	221	199	180	165	153	142	132	124
60	T	1472	2222	4538	2100	1575	1260	1050	900	788	700	630	573	525	485	450	420	394
	S	464	702	995	663	497	398	331	284	248	221	199	180	165	153	142	132	124
80	T	1472	2222	4538	2100	1575	1260	1050	900	788	700	630	573	525	485	450	420	394
	S	464	702	995	663	497	398	331	284	248	221	199	180	165	153	142	132	124
100	T	1472	2222	4538	2100	1575	1260	1050	900	788	700	630	573	525	485	450	420	394
	S	464	702	995	663	497	398	331	284	248	221	199	180	165	153	142	132	124
120	T	1472	2222	4538	2100	1575	1260	1050	900	788	700	630	573	525	485	450	420	394
	S	464	702	995	663	497	398	331	284	248	221	199	180	165	153	142	132	124
140	T	1472	2222	4538	2100	1575	1260	1050	900	788	700	630	573	525	485	450	420	394
	S	464	702	995	663	497	398	331	284	248	221	199	180	165	153	142	132	124
160	T	1472	2222	4538	2100	1575	1260	1050	900	788	700	630	573	525	485	450	420	394
	S	464	702	995	663	497	398	331	284	248	221	199	180	165	153	142	132	124
180	T	1472	2222	4538	2100	1575	1260	1050	900	788	700	630	573	525	485	450	420	394
	S	464	702	995	663	497	398	331	284	248	221	199	180	165	153	142	132	124
200	T	1472	2222	4538	2100	1575	1260	1050	900	788	700	630	573	525	485	450	420	394
	S	464	702	995	663	497	398	331	284	248	221	199	180	165	153	142	132	124
220	T	1472	2222	4538	2100	1575	1260	1050	900	788	700	630	573	525	485	450	420	394
	S	464	702	995	663	497	398	331	284	248	221	199	180	165	153	142	132	124
240	T	1472	2222	4538	2100	1575	1260	1050	900	788	700	630	573	525	485	450	420	394
	S	464	702	995	663	497	398	331	284	248	221	199	180	165	153	142	132	124

Characteristic load-carrying capacity $F_{4/5,Rk}$ (N) for two angle brackets

b / e (mm)		0	20	40	60	80	100	120	140	160	180	200	220	240	260	280	300	320
0	T	14400	14400	14400	14400	14400	14400	14400	14400	14400	14400	14400	14400	14400	14400	14400	14400	14400
	S	-	-	-	-	-	-	-	-	-	-	-	-	-	-	-	-	-
20	T	14400	1848	924	616	462	370	308	264	231	205	185	168	154	142	132	123	115
	S	-	906	453	302	226	181	151	129	113	100	90	82	75	69	64	60	56
40	T	14400	3695	1848	1232	924	739	616	528	462	411	370	336	308	284	264	246	231
	S	-	1812	906	604	453	362	302	258	226	201	181	164	151	139	129	120	113
60	T	14400	5543	2771	1848	1386	1109	924	792	693	616	554	504	462	426	396	370	346
	S	-	2719	1359	906	679	543	453	388	339	302	271	247	226	209	194	181	169
80	T	14400	7391	3695	2464	1848	1478	1232	1056	924	821	739	672	616	569	528	493	462
	S	-	3625	1812	1208	906	725	604	517	453	402	362	329	302	278	258	241	226
100	T	14400	9238	4619	3079	2310	1848	1540	1320	1155	1026	924	840	770	711	660	616	577
	S	-	4532	2266	1510	1133	906	755	647	566	503	453	412	377	348	323	302	283
120	T	14400	11086	5543	3695	2771	2217	1848	1584	1386	1232	1109	1008	924	853	792	739	693
	S	-	5438	2719	1812	1359	1087	906	776	679	604	543	494	453	418	388	362	339
140	T	14400	12933	6467	4311	3233	2587	2156	1848	1617	1437	1293	1176	1078	995	924	862	808
	S	-	6345	3172	2115	1586	1269	1057	906	793	705	634	576	528	488	453	423	396
160	T	14400	14400	7391	4927	3695	2956	2464	2112	1848	1642	1478	1344	1232	1137	1056	985	924
	S	-	7251	3625	2417	1812	1450	1208	1035	906	805	725	659	604	557	517	483	453
180	T	14400	14400	8314	5543	4157	3326	2771	2376	2079	1848	1663	1512	1386	1279	1188	1109	1039
	S	-	8158	4079	2719	2039	1631	1359	1165	1019	906	815	741	679	627	582	543	509
200	T	14400	14400	9238	6159	4619	3695	3079	2639	2310	2053	1848	1680	1540	1421	1320	1232	1155
	S	-	9064	4532	3021	2266	1812	1510	1294	1133	1007	906	824	755	697	647	604	566
220	T	14400	14400	10162	6775	5081	4065	3387	2903	2540	2258	2032	1848	1694	1563	1452	1355	1270
	S	-	9971	4985	3323	2492	1994	1661	1424	1246	1107	997	906	830	767	712	664	623
240	T	14400	14400	11086	7391	5543	4434	3695	3167	2771	2464	2217	2016	1848	1706	1584	1478	1386
	S	-	10877	5438	3625	2719	2175	1812	1553	1359	1208	1087	988	906	836	776	725	679

TTM: Timber-Timber-Maximum | TTP: Timber-Timber-Partial | TCM: Timber-Concrete-Maximum | TCP: Timber-Concrete-Partial

T: $F_{1,T,Rk}$ load-carrying capacity of timber | S: $F_{1,S,Rk}$ load-carrying capacity of steel

Table B. 111 Angle bracket type 9003S, Variant TTP, Fastener GH Nail 4x60, Density 350 kg/m³Characteristic load-carrying capacity $F_{T,Rk}$ (N) for one / two angle brackets

angle bracket		1													2
f (mm)		0	10	20	30	40	50	60	70	80	90	100	110	120	0
$F_{T,Rk}$	T	3079	2634	2302	2044	1838	1669	1529	1411	1310	1222	1145	1077	1017	6159
	S	906	775	677	601	540	491	450	393	344	305	275	250	229	1812

Characteristic load-carrying capacity $F_{2/3,Rk}$ (N) for one / two angle brackets

angle bracket		1	2
$F_{2/3,Rk}$	T	6760	13520
	S	-	-

Characteristic load-carrying capacity $F_{4,Rk}$ (N) for one angle bracket

e (mm)		0	20	40	60	80	100	120	140	160	180	200	220	240	260	280	300	320
$F_{4,Rk}$	T	14184	9115	4558	3038	2279	1823	1519	1302	1139	1013	912	829	760	701	651	603	557
	S	-	1990	995	663	497	398	331	284	248	221	195	171	152	137	124	114	105

Characteristic load-carrying capacity $F_{5,Rk}$ (N) for one angle bracket

b / e (mm)		0	20	40	60	80	100	120	140	160	180	200	220	240	260	280	300	320
0	T	2453	3704	3281	2188	1641	1313	1094	938	820	729	656	597	547	505	469	438	410
	S	464	702	995	663	497	398	331	284	248	221	199	180	165	153	142	132	124
20	T	2453	3704	6043	3500	2625	2100	1750	1500	1313	1167	1050	955	875	808	750	700	656
	S	464	702	995	663	497	398	331	284	248	221	199	180	165	153	142	132	124
40	T	2453	3704	7563	3500	2625	2100	1750	1500	1313	1167	1050	955	875	808	750	700	656
	S	464	702	995	663	497	398	331	284	248	221	199	180	165	153	142	132	124
60	T	2453	3704	7563	3500	2625	2100	1750	1500	1313	1167	1050	955	875	808	750	700	656
	S	464	702	995	663	497	398	331	284	248	221	199	180	165	153	142	132	124
80	T	2453	3704	7563	3500	2625	2100	1750	1500	1313	1167	1050	955	875	808	750	700	656
	S	464	702	995	663	497	398	331	284	248	221	199	180	165	153	142	132	124
100	T	2453	3704	7563	3500	2625	2100	1750	1500	1313	1167	1050	955	875	808	750	700	656
	S	464	702	995	663	497	398	331	284	248	221	199	180	165	153	142	132	124
120	T	2453	3704	7563	3500	2625	2100	1750	1500	1313	1167	1050	955	875	808	750	700	656
	S	464	702	995	663	497	398	331	284	248	221	199	180	165	153	142	132	124
140	T	2453	3704	7563	3500	2625	2100	1750	1500	1313	1167	1050	955	875	808	750	700	656
	S	464	702	995	663	497	398	331	284	248	221	199	180	165	153	142	132	124
160	T	2453	3704	7563	3500	2625	2100	1750	1500	1313	1167	1050	955	875	808	750	700	656
	S	464	702	995	663	497	398	331	284	248	221	199	180	165	153	142	132	124
180	T	2453	3704	7563	3500	2625	2100	1750	1500	1313	1167	1050	955	875	808	750	700	656
	S	464	702	995	663	497	398	331	284	248	221	199	180	165	153	142	132	124
200	T	2453	3704	7563	3500	2625	2100	1750	1500	1313	1167	1050	955	875	808	750	700	656
	S	464	702	995	663	497	398	331	284	248	221	199	180	165	153	142	132	124
220	T	2453	3704	7563	3500	2625	2100	1750	1500	1313	1167	1050	955	875	808	750	700	656
	S	464	702	995	663	497	398	331	284	248	221	199	180	165	153	142	132	124
240	T	2453	3704	7563	3500	2625	2100	1750	1500	1313	1167	1050	955	875	808	750	700	656
	S	464	702	995	663	497	398	331	284	248	221	199	180	165	153	142	132	124

Characteristic load-carrying capacity $F_{4/5,Rk}$ (N) for two angle brackets

b / e (mm)		0	20	40	60	80	100	120	140	160	180	200	220	240	260	280	300	320
0	T	23999	23999	23999	23999	23999	23999	23999	23999	23999	23999	23999	23999	23999	23999	23999	23999	23999
	S	-	-	-	-	-	-	-	-	-	-	-	-	-	-	-	-	-
20	T	23999	3079	1540	1026	770	616	513	440	385	342	308	280	257	237	220	205	192
	S	-	906	453	302	226	181	151	129	113	100	90	82	75	69	64	60	56
40	T	23999	6159	3079	2053	1540	1232	1026	880	770	684	616	560	513	474	440	411	385
	S	-	1812	906	604	453	362	302	258	226	201	181	164	151	139	129	120	113
60	T	23999	9238	4619	3079	2310	1848	1540	1320	1155	1026	924	840	770	711	660	616	577
	S	-	2719	1359	906	679	543	453	388	339	302	271	247	226	209	194	181	169
80	T	23999	12318	6159	4106	3079	2464	2053	1760	1540	1369	1232	1120	1026	948	880	821	770
	S	-	3625	1812	1208	906	725	604	517	453	402	362	329	302	278	258	241	226
100	T	23999	15397	7698	5132	3849	3079	2566	2200	1925	1711	1540	1400	1283	1184	1100	1026	962
	S	-	4532	2266	1510	1133	906	755	647	566	503	453	412	377	348	323	302	283
120	T	23999	18476	9238	6159	4619	3695	3079	2639	2310	2053	1848	1680	1540	1421	1320	1232	1155
	S	-	5438	2719	1812	1359	1087	906	776	679	604	543	494	453	418	388	362	339
140	T	23999	21556	10778	7185	5389	4311	3593	3079	2694	2395	2156	1960	1796	1658	1540	1437	1347
	S	-	6345	3172	2115	1586	1269	1057	906	793	705	634	576	528	488	453	423	396
160	T	23999	24000	12318	8212	6159	4927	4106	3519	3079	2737	2464	2240	2053	1895	1760	1642	1540
	S	-	7251	3625	2417	1812	1450	1208	1035	906	805	725	659	604	557	517	483	453
180	T	23999	24000	13857	9238	6929	5543	4619	3959	3464	3079	2771	2520	2310	2132	1980	1848	1732
	S	-	8158	4079	2719	2039	1631	1359	1165	1019	906	815	741	679	627	582	543	509
200	T	23999	24000	15397	10265	7698	6159	5132	4399	3849	3422	3079	2799	2566	2369	2200	2053	1925
	S	-	9064	4532	3021	2266	1812	1510	1294	1133	1007	906	824	755	697	647	604	566
220	T	23999	24000	16937	11291	8468	6775	5646	4839	4234	3764	3387	3079	2823	2606	2420	2258	2117
	S	-	9971	4985	3323	2492	1994	1661	1424	1246	1107	997	906	830	767	712	664	623
240	T	23999	24000	18476	12318	9238	7391	6159	5279	4619	4106	3695	3359	3079	2843	2639	2464	2310
	S	-	10877	5438	3625	2719	2175	1812	1553	1359	1208	1087	988	906	836	776	725	679

TTM: Timber-Timber-Maximum | TTP: Timber-Timber-Partial | TCM: Timber-Concrete-Maximum | TCP: Timber-Concrete-Partial

T: $F_{T,Rk}$ load-carrying capacity of timber | S: $F_{S,Rk}$ load-carrying capacity of steel

Table B. 112 Angle bracket type 9003S, Variant TTP, Fastener GH Screw 5x40, Density 350 kg/m³Characteristic load-carrying capacity $F_{1,Rk}$ (N) for one / two angle brackets

angle bracket		1												2	
f (mm)		0	10	20	30	40	50	60	70	80	90	100	110	120	0
$F_{1,Rk}$	T	3880	3319	2900	2575	2316	2103	1927	1778	1650	1540	1443	1358	1282	7760
	S	906	775	677	601	540	491	450	393	344	305	275	250	229	1812

Characteristic load-carrying capacity $F_{2/3,Rk}$ (N) for one / two angle brackets

angle bracket		1	2
$F_{2/3,Rk}$	T	5730	11460
	S	-	-

Characteristic load-carrying capacity $F_{4,Rk}$ (N) for one angle bracket

e (mm)		0	20	40	60	80	100	120	140	160	180	200	220	240	260	280	300	320
$F_{4,Rk}$	T	12018	11485	5742	3828	2871	2297	1914	1641	1436	1276	1148	1044	957	883	820	760	702
	S	-	1990	995	663	497	398	331	284	248	221	195	171	152	137	124	114	105

Characteristic load-carrying capacity $F_{5,Rk}$ (N) for one angle bracket

b / e (mm)		0	20	40	60	80	100	120	140	160	180	200	220	240	260	280	300	320
0	T	3090	4667	4134	2756	2067	1654	1378	1181	1034	919	827	752	689	636	591	551	517
	S	464	702	995	663	497	398	331	284	248	221	199	180	165	153	142	132	124
20	T	3090	4667	7614	4410	3308	2646	2205	1890	1654	1470	1323	1203	1103	1018	945	882	827
	S	464	702	995	663	497	398	331	284	248	221	199	180	165	153	142	132	124
40	T	3090	4667	9529	4410	3308	2646	2205	1890	1654	1470	1323	1203	1103	1018	945	882	827
	S	464	702	995	663	497	398	331	284	248	221	199	180	165	153	142	132	124
60	T	3090	4667	9529	4410	3308	2646	2205	1890	1654	1470	1323	1203	1103	1018	945	882	827
	S	464	702	995	663	497	398	331	284	248	221	199	180	165	153	142	132	124
80	T	3090	4667	9529	4410	3308	2646	2205	1890	1654	1470	1323	1203	1103	1018	945	882	827
	S	464	702	995	663	497	398	331	284	248	221	199	180	165	153	142	132	124
100	T	3090	4667	9529	4410	3308	2646	2205	1890	1654	1470	1323	1203	1103	1018	945	882	827
	S	464	702	995	663	497	398	331	284	248	221	199	180	165	153	142	132	124
120	T	3090	4667	9529	4410	3308	2646	2205	1890	1654	1470	1323	1203	1103	1018	945	882	827
	S	464	702	995	663	497	398	331	284	248	221	199	180	165	153	142	132	124
140	T	3090	4667	9529	4410	3308	2646	2205	1890	1654	1470	1323	1203	1103	1018	945	882	827
	S	464	702	995	663	497	398	331	284	248	221	199	180	165	153	142	132	124
160	T	3090	4667	9529	4410	3308	2646	2205	1890	1654	1470	1323	1203	1103	1018	945	882	827
	S	464	702	995	663	497	398	331	284	248	221	199	180	165	153	142	132	124
180	T	3090	4667	9529	4410	3308	2646	2205	1890	1654	1470	1323	1203	1103	1018	945	882	827
	S	464	702	995	663	497	398	331	284	248	221	199	180	165	153	142	132	124
200	T	3090	4667	9529	4410	3308	2646	2205	1890	1654	1470	1323	1203	1103	1018	945	882	827
	S	464	702	995	663	497	398	331	284	248	221	199	180	165	153	142	132	124
220	T	3090	4667	9529	4410	3308	2646	2205	1890	1654	1470	1323	1203	1103	1018	945	882	827
	S	464	702	995	663	497	398	331	284	248	221	199	180	165	153	142	132	124
240	T	3090	4667	9529	4410	3308	2646	2205	1890	1654	1470	1323	1203	1103	1018	945	882	827
	S	464	702	995	663	497	398	331	284	248	221	199	180	165	153	142	132	124

Characteristic load-carrying capacity $F_{4/5,Rk}$ (N) for two angle brackets

b / e (mm)		0	20	40	60	80	100	120	140	160	180	200	220	240	260	280	300	320
0	T	24035	24035	24035	24035	24035	24035	24035	24035	24035	24035	24035	24035	24035	24035	24035	24035	24035
	S	-	-	-	-	-	-	-	-	-	-	-	-	-	-	-	-	-
20	T	24035	3880	1940	1293	970	776	647	554	485	431	388	353	323	298	277	259	243
	S	-	906	453	302	226	181	151	129	113	100	90	82	75	69	64	60	56
40	T	24035	7760	3880	2587	1940	1552	1293	1109	970	862	776	705	647	597	554	517	485
	S	-	1812	906	604	453	362	302	258	226	201	181	164	151	139	129	120	113
60	T	24035	11640	5820	3880	2910	2328	1940	1663	1455	1293	1164	1058	970	895	831	776	728
	S	-	2719	1359	906	679	543	453	388	339	302	271	247	226	209	194	181	169
80	T	24035	15520	7760	5173	3880	3104	2587	2217	1940	1724	1552	1411	1293	1194	1109	1035	970
	S	-	3625	1812	1208	906	725	604	517	453	402	362	329	302	278	258	241	226
100	T	24035	19400	9700	6467	4850	3880	3233	2771	2425	2156	1940	1764	1617	1492	1386	1293	1213
	S	-	4532	2266	1510	1133	906	755	647	566	503	453	412	377	348	323	302	283
120	T	24035	23280	11640	7760	5820	4656	3880	3326	2910	2587	2328	2116	1940	1791	1663	1552	1455
	S	-	5438	2719	1812	1359	1087	906	776	679	604	543	494	453	418	388	362	339
140	T	24035	24036	13580	9053	6790	5432	4527	3880	3395	3018	2716	2469	2263	2089	1940	1811	1698
	S	-	6345	3172	2115	1586	1269	1057	906	793	705	634	576	528	488	453	423	396
160	T	24035	24036	15520	10347	7760	6208	5173	4434	3880	3449	3104	2822	2587	2388	2217	2069	1940
	S	-	7251	3625	2417	1812	1450	1208	1035	906	805	725	659	604	557	517	483	453
180	T	24035	24036	17460	11640	8730	6984	5820	4989	4365	3880	3492	3175	2910	2686	2494	2328	2183
	S	-	8158	4079	2719	2039	1631	1359	1165	1019	906	815	741	679	627	582	543	509
200	T	24035	24036	19400	12933	9700	7760	6467	5543	4850	4311	3880	3527	3233	2985	2771	2587	2425
	S	-	9064	4532	3021	2266	1812	1510	1294	1133	1007	906	824	755	697	647	604	566
220	T	24035	24036	21340	14227	10670	8536	7113	6097	5335	4742	4268	3880	3557	3283	3049	2845	2668
	S	-	9971	4985	3323	2492	1994	1661	1424	1246	1107	997	906	830	767	712	664	623
240	T	24035	24036	23280	15520	11640	9312	7760	6651	5820	5173	4656	4233	3880	3582	3326	3104	2910
	S	-	10877	5438	3625	2719	2175	1812	1553	1359	1208	1087	988	906	836	776	725	679

TTM: Timber-Timber-Maximum | TTP: Timber-Timber-Partial | TCM: Timber-Concrete-Maximum | TCP: Timber-Concrete-Partial

T: $F_{1,T,Rk}$ load-carrying capacity of timber | S: $F_{1,S,Rk}$ load-carrying capacity of steel

Table B. 113 Angle bracket type 9003S, Variant TTP, Fastener GH Screw 5x60, Density 350 kg/m³Characteristic load-carrying capacity $F_{T,Rk}$ (N) for one / two angle brackets

angle bracket		1												2	
f (mm)		0	10	20	30	40	50	60	70	80	90	100	110	120	0
$F_{T,Rk}$	T	6036	5163	4511	4006	3602	3272	2998	2766	2567	2395	2244	2112	1994	12071
	S	906	775	677	601	540	491	450	393	344	305	275	250	229	1812

Characteristic load-carrying capacity $F_{2/3,Rk}$ (N) for one / two angle brackets

angle bracket		1	2
$F_{2/3,Rk}$	T	6480	12960
	S	-	-

Characteristic load-carrying capacity $F_{4,Rk}$ (N) for one angle bracket

e (mm)		0	20	40	60	80	100	120	140	160	180	200	220	240	260	280	300	320
$F_{4,Rk}$	T	13590	13590	8933	5955	4466	3573	2978	2552	2233	1985	1787	1624	1489	1374	1276	1182	1091
	S	-	1990	995	663	497	398	331	284	248	221	195	171	152	137	124	114	105

Characteristic load-carrying capacity $F_{5,Rk}$ (N) for one angle bracket

b / e (mm)		0	20	40	60	80	100	120	140	160	180	200	220	240	260	280	300	320
0	T	4807	7260	6431	4288	3216	2573	2144	1838	1608	1429	1286	1169	1072	989	919	858	804
	S	464	702	995	663	497	398	331	284	248	221	199	180	165	153	142	132	124
20	T	4807	7260	11844	6040	4530	3624	3020	2589	2265	2013	1812	1647	1510	1394	1294	1208	1133
	S	464	702	995	663	497	398	331	284	248	221	199	180	165	153	142	132	124
40	T	4807	7260	13590	6860	5145	4116	3430	2940	2573	2287	2058	1871	1715	1583	1470	1372	1286
	S	464	702	995	663	497	398	331	284	248	221	199	180	165	153	142	132	124
60	T	4807	7260	13590	6860	5145	4116	3430	2940	2573	2287	2058	1871	1715	1583	1470	1372	1286
	S	464	702	995	663	497	398	331	284	248	221	199	180	165	153	142	132	124
80	T	4807	7260	13590	6860	5145	4116	3430	2940	2573	2287	2058	1871	1715	1583	1470	1372	1286
	S	464	702	995	663	497	398	331	284	248	221	199	180	165	153	142	132	124
100	T	4807	7260	13590	6860	5145	4116	3430	2940	2573	2287	2058	1871	1715	1583	1470	1372	1286
	S	464	702	995	663	497	398	331	284	248	221	199	180	165	153	142	132	124
120	T	4807	7260	13590	6860	5145	4116	3430	2940	2573	2287	2058	1871	1715	1583	1470	1372	1286
	S	464	702	995	663	497	398	331	284	248	221	199	180	165	153	142	132	124
140	T	4807	7260	13590	6860	5145	4116	3430	2940	2573	2287	2058	1871	1715	1583	1470	1372	1286
	S	464	702	995	663	497	398	331	284	248	221	199	180	165	153	142	132	124
160	T	4807	7260	13590	6860	5145	4116	3430	2940	2573	2287	2058	1871	1715	1583	1470	1372	1286
	S	464	702	995	663	497	398	331	284	248	221	199	180	165	153	142	132	124
180	T	4807	7260	13590	6860	5145	4116	3430	2940	2573	2287	2058	1871	1715	1583	1470	1372	1286
	S	464	702	995	663	497	398	331	284	248	221	199	180	165	153	142	132	124
200	T	4807	7260	13590	6860	5145	4116	3430	2940	2573	2287	2058	1871	1715	1583	1470	1372	1286
	S	464	702	995	663	497	398	331	284	248	221	199	180	165	153	142	132	124
220	T	4807	7260	13590	6860	5145	4116	3430	2940	2573	2287	2058	1871	1715	1583	1470	1372	1286
	S	464	702	995	663	497	398	331	284	248	221	199	180	165	153	142	132	124
240	T	4807	7260	13590	6860	5145	4116	3430	2940	2573	2287	2058	1871	1715	1583	1470	1372	1286
	S	464	702	995	663	497	398	331	284	248	221	199	180	165	153	142	132	124

Characteristic load-carrying capacity $F_{4/5,Rk}$ (N) for two angle brackets

b / e (mm)		0	20	40	60	80	100	120	140	160	180	200	220	240	260	280	300	320
0	T	27179	27179	27179	27179	27179	27179	27179	27179	27179	27179	27179	27179	27179	27179	27179	27179	27179
	S	-	-	-	-	-	-	-	-	-	-	-	-	-	-	-	-	-
20	T	27179	6036	3018	2012	1509	1207	1006	862	754	671	604	549	503	464	431	402	377
	S	-	906	453	302	226	181	151	129	113	100	90	82	75	69	64	60	56
40	T	27179	12071	6036	4024	3018	2414	2012	1724	1509	1341	1207	1097	1006	929	862	805	754
	S	-	1812	906	604	453	362	302	258	226	201	181	164	151	139	129	120	113
60	T	27179	18107	9053	6036	4527	3621	3018	2587	2263	2012	1811	1646	1509	1393	1293	1207	1132
	S	-	2719	1359	906	679	543	453	388	339	302	271	247	226	209	194	181	169
80	T	27179	24142	12071	8047	6036	4828	4024	3449	3018	2682	2414	2195	2012	1857	1724	1609	1509
	S	-	3625	1812	1208	906	725	604	517	453	402	362	329	302	278	258	241	226
100	T	27179	27180	15089	10059	7545	6036	5030	4311	3772	3353	3018	2743	2515	2321	2156	2012	1886
	S	-	4532	2266	1510	1133	906	755	647	566	503	453	412	377	348	323	302	283
120	T	27179	27180	18107	12071	9053	7243	6036	5173	4527	4024	3621	3292	3018	2786	2587	2414	2263
	S	-	5438	2719	1812	1359	1087	906	776	679	604	543	494	453	418	388	362	339
140	T	27179	27180	21125	14083	10562	8450	7042	6036	5281	4694	4225	3841	3521	3250	3018	2817	2641
	S	-	6345	3172	2115	1586	1269	1057	906	793	705	634	576	528	488	453	423	396
160	T	27179	27180	24142	16095	12071	9657	8047	6898	6036	5365	4828	4390	4024	3714	3449	3219	3018
	S	-	7251	3625	2417	1812	1450	1208	1035	906	805	725	659	604	557	517	483	453
180	T	27179	27180	27160	18107	13580	10864	9053	7760	6790	6036	5432	4938	4527	4178	3880	3621	3395
	S	-	8158	4079	2719	2039	1631	1359	1165	1019	906	815	741	679	627	582	543	509
200	T	27179	27180	27180	20119	15089	12071	10059	8622	7545	6706	6036	5487	5030	4643	4311	4024	3772
	S	-	9064	4532	3021	2266	1812	1510	1294	1133	1007	906	824	755	697	647	604	566
220	T	27179	27180	27180	22131	16598	13278	11065	9485	8299	7377	6639	6036	5533	5107	4742	4426	4149
	S	-	9971	4985	3323	2492	1994	1661	1424	1246	1107	997	906	830	767	712	664	623
240	T	27179	27180	27180	24142	18107	14485	12071	10347	9053	8047	7243	6584	6036	5571	5173	4828	4527
	S	-	10877	5438	3625	2719	2175	1812	1553	1359	1208	1087	988	906	836	776	725	679

TTM: Timber-Timber-Maximum | TTP: Timber-Timber-Partial | TCM: Timber-Concrete-Maximum | TCP: Timber-Concrete-Partial

T: $F_{T,Rk}$ load-carrying capacity of timber | S: $F_{S,Rk}$ load-carrying capacity of steel

Table B. 114 Angle bracket type 9004S, Variant TCM, Fastener GH Nail 4x40, Density 350 kg/m³Characteristic load-carrying capacity $F_{T,Rk}$ (N) for one / two angle brackets

angle bracket		1												2	
f (mm)		0	10	20	30	40	50	60	70	80	90	100	110	120	0
$F_{T,Rk}$	T	22680	900	450	300	225	180	150	129	113	100	90	82	75	45360
	S	356	267	169	113	84	67	56	48	42	37	33	30	28	
k_t (-)		5,5	7,3	9,1	10,9	12,7	14,5	16,4	18,2	20,0	21,8	23,6	25,5	27,3	2,7

Characteristic load-carrying capacity $F_{2/3,Rk}$ (N) for one / two angle brackets

angle bracket		1	2
$F_{2/3,Rk}$	T	4540	9080
	S	-	-

Characteristic load-carrying capacity $F_{4,Rk}$ (N) for one angle bracket

e (mm)		0	20	40	60	80	100	120	140	160	180	200	220	240	260	280	300	320
$F_{4,Rk}$	T	-	-	3600	400	212	144	109	88	73	63	55	49	44	40	37	34	32
	S	-	534	267	151	79	54	41	33	27	23	20	18	16	15	14	12	12
k_t (-)		0,0	3,6	7,3	10,9	14,5	18,2	21,8	25,5	29,1	32,7	36,4	40,0	43,6	47,3	50,9	54,5	58,2

Characteristic load-carrying capacity $F_{5,Rk}$ (N) for one angle bracket

b / e (mm)		0	20	40	60	80	100	120	140	160	180	200	220	240	260	280	300	320
0	T	240	514	3150	2100	1575	1260	1050	900	788	700	630	573	525	485	450	420	394
	S	90	194	1189	793	594	475	396	339	297	264	237	216	198	183	169	158	148
20	T	240	514	3150	2100	1575	1260	1050	900	788	700	630	573	525	485	450	420	394
	S	90	194	1189	793	594	475	396	339	297	264	237	216	198	183	169	158	148
40	T	240	514	3150	2100	1575	1260	1050	900	788	700	630	573	525	485	450	420	394
	S	90	194	1189	793	594	475	396	339	297	264	237	216	198	183	169	158	148
60	T	240	514	3150	2100	1575	1260	1050	900	788	700	630	573	525	485	450	420	394
	S	90	194	1189	793	594	475	396	339	297	264	237	216	198	183	169	158	148
80	T	240	514	3150	2100	1575	1260	1050	900	788	700	630	573	525	485	450	420	394
	S	90	194	1189	793	594	475	396	339	297	264	237	216	198	183	169	158	148
100	T	240	514	3150	2100	1575	1260	1050	900	788	700	630	573	525	485	450	420	394
	S	90	194	1189	793	594	475	396	339	297	264	237	216	198	183	169	158	148
120	T	240	514	3150	2100	1575	1260	1050	900	788	700	630	573	525	485	450	420	394
	S	90	194	1189	793	594	475	396	339	297	264	237	216	198	183	169	158	148
140	T	240	514	3150	2100	1575	1260	1050	900	788	700	630	573	525	485	450	420	394
	S	90	194	1189	793	594	475	396	339	297	264	237	216	198	183	169	158	148
160	T	240	514	3150	2100	1575	1260	1050	900	788	700	630	573	525	485	450	420	394
	S	90	194	1189	793	594	475	396	339	297	264	237	216	198	183	169	158	148
180	T	240	514	3150	2100	1575	1260	1050	900	788	700	630	573	525	485	450	420	394
	S	90	194	1189	793	594	475	396	339	297	264	237	216	198	183	169	158	148
200	T	240	514	3150	2100	1575	1260	1050	900	788	700	630	573	525	485	450	420	394
	S	90	194	1189	793	594	475	396	339	297	264	237	216	198	183	169	158	148
220	T	240	514	3150	2100	1575	1260	1050	900	788	700	630	573	525	485	450	420	394
	S	90	194	1189	793	594	475	396	339	297	264	237	216	198	183	169	158	148
240	T	240	514	3150	2100	1575	1260	1050	900	788	700	630	573	525	485	450	420	394
	S	90	194	1189	793	594	475	396	339	297	264	237	216	198	183	169	158	148
$k_x \times b$ (-)		0,0	18,1	36,3	54,4	72,6	90,7	108,9	127,0	145,2	163,3	181,5	199,6	217,8	235,9	254,1	272,2	290,4

Characteristic load-carrying capacity $F_{4/5,Rk}$ (N) for two angle brackets

b / e (mm)		0	20	40	60	80	100	120	140	160	180	200	220	240	260	280	300	320
0	T	21599	21599	21599	21599	21599	21599	21599	21599	21599	21599	21599	21599	21599	21599	21599	21599	21599
	S	-	-	-	-	-	-	-	-	-	-	-	-	-	-	-	-	-
20	T	21599	21600	11340	7560	5670	4536	3780	3240	2835	2520	2268	2062	1890	1745	1620	1512	1418
	S	-	356	178	118	89	71	59	50	44	39	35	32	29	27	25	23	22
40	T	21599	21600	21600	15120	11340	9072	7560	6480	5670	5040	4536	4124	3780	3489	3240	3024	2835
	S	-	712	356	237	178	142	118	101	89	79	71	64	59	54	50	47	44
60	T	21599	21600	21600	21600	17010	13608	11340	9720	8505	7560	6804	6185	5670	5234	4860	4536	4253
	S	-	1068	534	356	267	213	178	152	133	118	106	97	89	82	76	71	66
80	T	21599	21600	21600	21600	21600	18144	15120	12960	11340	10080	9072	8247	7560	6978	6480	6048	5670
	S	-	1424	712	474	356	284	237	203	178	158	142	129	118	109	101	94	89
100	T	21599	21600	21600	21600	21600	18900	16200	14175	12600	11340	10309	9450	8723	8100	7560	7088	6708
	S	-	1780	890	593	445	356	296	254	222	197	178	161	148	136	127	118	111
120	T	21599	21600	21600	21600	21600	21600	19440	17010	15120	13608	12371	11340	10468	9720	9072	8505	8050
	S	-	2136	1068	712	534	427	356	305	267	237	213	194	178	164	152	142	133
140	T	21599	21600	21600	21600	21600	21600	21600	19845	17640	15876	14433	13230	12212	11340	10584	9923	9423
	S	-	2492	1246	830	623	498	415	356	311	276	249	226	207	191	178	166	155
160	T	21599	21600	21600	21600	21600	21600	21600	21600	20160	18144	16495	15120	13957	12960	12096	11340	10740
	S	-	2848	1424	949	712	569	474	406	356	316	284	258	237	219	203	189	178
180	T	21599	21600	21600	21600	21600	21600	21600	21600	21600	20412	18556	17010	15702	14580	13608	12758	12158
	S	-	3204	1602	1068	801	640	534	457	400	356	320	291	267	246	228	213	200
200	T	21599	21600	21600	21600	21600	21600	21600	21600	21600	21600	21600	20618	18900	17446	16200	15120	14175
	S	-	3560	1780	1186	890	712	593	508	445	395	356	323	296	273	254	237	222
220	T	21599	21600	21600	21600	21600	21600	21600	21600	21600	21600	21600	20790	19191	17820	16632	15593	14743
	S	-	3917	1958	1305	979	783	652	559	489	435	391	356	326	301	279	261	244
240	T	21599	21600	21600	21600	21600	21600	21600	21600	21600	21600	21600	21600	20935	19440	18144	17010	16160
	S	-	4273	2136	1424	1068	854	712	610	534	474	427	388	356	328	305	284	267
$k_x \times b$ (-)		0,0	109,1	218,2	327,3	436,4	545,5	654,5	763,6	872,7	981,8	1090,9	1200,0	1309,1	1418,2	1527,3	1636,4	1745,5

TTM: Timber-Timber-Maximum | TTP: Timber-Timber-Partial | TCM: Timber-Concrete-Maximum | TCP: Timber-Concrete-Partial

T: $F_{T,Rk}$ load-carrying capacity of timber | S: $F_{S,Rk}$ load-carrying capacity of steel

Table B. 115 Angle bracket type 9004S, Variant TCM, Fastener GH Nail 4x60, Density 350 kg/m³Characteristic load-carrying capacity $F_{T,Rk}$ (N) for one / two angle brackets

angle bracket		1												2	
f (mm)		0	10	20	30	40	50	60	70	80	90	100	110	120	0
$F_{T,Rk}$	T	28368	1500	750	500	375	300	250	214	188	167	150	136	125	56736
	S	356	267	169	113	84	67	56	48	42	37	33	30	28	712
k_t (-)		5,5	7,3	9,1	10,9	12,7	14,5	16,4	18,2	20,0	21,8	23,6	25,5	27,3	2,7

Characteristic load-carrying capacity $F_{2/3,Rk}$ (N) for one / two angle brackets

angle bracket		1	2
$F_{2/3,Rk}$	T	6610	13220
	S	-	-

Characteristic load-carrying capacity $F_{4,Rk}$ (N) for one angle bracket

e (mm)		0	20	40	60	80	100	120	140	160	180	200	220	240	260	280	300	320
$F_{4,Rk}$	T	-	-	6000	667	353	240	182	146	122	105	92	82	74	67	62	57	53
	S	-	534	267	151	79	54	41	33	27	23	20	18	16	15	14	12	12
k_t (-)		0,0	3,6	7,3	10,9	14,5	18,2	21,8	25,5	29,1	32,7	36,4	40,0	43,6	47,3	50,9	54,5	58,2

Characteristic load-carrying capacity $F_{5,Rk}$ (N) for one angle bracket

b / e (mm)		0	20	40	60	80	100	120	140	160	180	200	220	240	260	280	300	320
0	T	400	857	5250	3500	2625	2100	1750	1500	1313	1167	1050	955	875	808	750	700	656
	S	90	194	1189	793	594	475	396	339	297	264	237	216	198	183	169	158	148
20	T	400	857	5250	3500	2625	2100	1750	1500	1313	1167	1050	955	875	808	750	700	656
	S	90	194	1189	793	594	475	396	339	297	264	237	216	198	183	169	158	148
40	T	400	857	5250	3500	2625	2100	1750	1500	1313	1167	1050	955	875	808	750	700	656
	S	90	194	1189	793	594	475	396	339	297	264	237	216	198	183	169	158	148
60	T	400	857	5250	3500	2625	2100	1750	1500	1313	1167	1050	955	875	808	750	700	656
	S	90	194	1189	793	594	475	396	339	297	264	237	216	198	183	169	158	148
80	T	400	857	5250	3500	2625	2100	1750	1500	1313	1167	1050	955	875	808	750	700	656
	S	90	194	1189	793	594	475	396	339	297	264	237	216	198	183	169	158	148
100	T	400	857	5250	3500	2625	2100	1750	1500	1313	1167	1050	955	875	808	750	700	656
	S	90	194	1189	793	594	475	396	339	297	264	237	216	198	183	169	158	148
120	T	400	857	5250	3500	2625	2100	1750	1500	1313	1167	1050	955	875	808	750	700	656
	S	90	194	1189	793	594	475	396	339	297	264	237	216	198	183	169	158	148
140	T	400	857	5250	3500	2625	2100	1750	1500	1313	1167	1050	955	875	808	750	700	656
	S	90	194	1189	793	594	475	396	339	297	264	237	216	198	183	169	158	148
160	T	400	857	5250	3500	2625	2100	1750	1500	1313	1167	1050	955	875	808	750	700	656
	S	90	194	1189	793	594	475	396	339	297	264	237	216	198	183	169	158	148
180	T	400	857	5250	3500	2625	2100	1750	1500	1313	1167	1050	955	875	808	750	700	656
	S	90	194	1189	793	594	475	396	339	297	264	237	216	198	183	169	158	148
200	T	400	857	5250	3500	2625	2100	1750	1500	1313	1167	1050	955	875	808	750	700	656
	S	90	194	1189	793	594	475	396	339	297	264	237	216	198	183	169	158	148
220	T	400	857	5250	3500	2625	2100	1750	1500	1313	1167	1050	955	875	808	750	700	656
	S	90	194	1189	793	594	475	396	339	297	264	237	216	198	183	169	158	148
240	T	400	857	5250	3500	2625	2100	1750	1500	1313	1167	1050	955	875	808	750	700	656
	S	90	194	1189	793	594	475	396	339	297	264	237	216	198	183	169	158	148
$k_x \times b$ (-)		0,0	18,1	36,3	54,4	72,6	90,7	108,9	127,0	145,2	163,3	181,5	199,6	217,8	235,9	254,1	272,2	290,4

Characteristic load-carrying capacity $F_{4/5,Rk}$ (N) for two angle brackets

b / e (mm)		0	20	40	60	80	100	120	140	160	180	200	220	240	260	280	300	320
0	T	35999	35999	35999	35999	35999	35999	35999	35999	35999	35999	35999	35999	35999	35999	35999	35999	35999
	S	-	-	-	-	-	-	-	-	-	-	-	-	-	-	-	-	-
20	T	35999	28368	14184	9456	7092	5674	4728	4053	3546	3152	2837	2579	2364	2182	2026	1891	1773
	S	-	356	178	118	89	71	59	50	44	39	35	32	29	27	25	23	22
40	T	35999	36000	28368	18912	14184	11347	9456	8105	7092	6304	5674	5158	4728	4364	4053	3782	3546
	S	-	712	356	237	178	142	118	101	89	79	71	64	59	54	50	47	44
60	T	35999	36000	36000	28368	21276	17021	14184	12158	10638	9456	8510	7737	7092	6546	6079	5674	5319
	S	-	1068	534	356	267	213	178	152	133	118	106	97	89	82	76	71	66
80	T	35999	36000	36000	36000	28368	22694	18912	16210	14184	12608	11347	10316	9456	8729	8105	7565	7092
	S	-	1424	712	474	356	284	237	203	178	158	142	129	118	109	101	94	89
100	T	35999	36000	36000	36000	35460	28368	23640	20263	17730	15760	14184	12895	11820	10911	10131	9456	8865
	S	-	1780	890	593	445	356	296	254	222	197	178	161	148	136	127	118	111
120	T	35999	36000	36000	36000	36000	34042	28368	24315	21276	18912	17021	15473	14184	13093	12158	11347	10638
	S	-	2136	1068	712	534	427	356	305	267	237	213	194	178	164	152	142	133
140	T	35999	36000	36000	36000	36000	33096	28368	24822	22064	19858	18052	16548	15275	14184	13238	12411	
	S	-	2492	1246	830	623	498	415	356	311	276	249	226	207	191	178	166	155
160	T	35999	36000	36000	36000	36000	36000	36000	32421	28368	25216	22694	20631	18912	17457	16210	15130	14184
	S	-	2848	1424	949	712	569	474	406	356	316	284	258	237	219	203	189	178
180	T	35999	36000	36000	36000	36000	36000	36000	36000	31914	28368	25531	23210	21276	19639	18237	17021	15957
	S	-	3204	1602	1068	801	640	534	457	400	356	320	291	267	246	228	213	200
200	T	35999	36000	36000	36000	36000	36000	36000	36000	35460	31520	28368	25789	23640	21822	20263	18912	17730
	S	-	3560	1780	1186	890	712	593	508	445	395	356	323	296	273	254	237	222
220	T	35999	36000	36000	36000	36000	36000	36000	36000	36000	34672	31205	28368	26004	24004	22289	20803	19503
	S	-	3917	1958	1305	979	783	652	559	489	435	391	356	326	301	279	261	244
240	T	35999	36000	36000	36000	36000	36000	36000	36000	36000	36000	34042	30947	28368	26186	24315	22694	21276
	S	-	4273	2136	1424	1068	854	712	610	534	474	427	388	356	328	305	284	267
$k_x \times b$ (-)		0,0	109,1	218,2	327,3	436,4	545,5	654,5	763,6	872,7	981,8	1090,9	1200,0	1309,1	1418,2	1527,3	1636,4	1745,5

TTM: Timber-Timber-Maximum | TTP: Timber-Timber-Partial | TCM: Timber-Concrete-Maximum | TCP: Timber-Concrete-Partial

T: $F_{T,Rk}$ load-carrying capacity of timber | S: $F_{S,Rk}$ load-carrying capacity of steel

Table B. 116 Angle bracket type 9004S, Variant TCM, Fastener GH Screw 5x40, Density 350 kg/m³Characteristic load-carrying capacity $F_{1,Rk}$ (N) for one / two angle brackets

angle bracket	1													2	
f (mm)	0	10	20	30	40	50	60	70	80	90	100	110	120	0	
$F_{1,Rk}$	T	24036	1890	945	630	473	378	315	270	236	210	189	172	158	48072
	S	356	267	169	113	84	67	56	48	42	37	33	30	28	712
k_1 (-)		5,5	7,3	9,1	10,9	12,7	14,5	16,4	18,2	20,0	21,8	23,6	25,5	27,3	2,7

Characteristic load-carrying capacity $F_{2/3,Rk}$ (N) for one / two angle brackets

angle bracket	1	2	
$F_{2/3,Rk}$	T	6460	12920
	S	-	-

Characteristic load-carrying capacity $F_{4,Rk}$ (N) for one angle bracket

e (mm)	0	20	40	60	80	100	120	140	160	180	200	220	240	260	280	300	320	
$F_{4,Rk}$	T	-	-	7560	840	445	302	229	184	154	133	116	104	93	85	78	72	67
	S	-	534	267	151	79	54	41	33	27	23	20	18	16	15	14	12	12
k_1 (-)		0,0	3,6	7,3	10,9	14,5	18,2	21,8	25,5	29,1	32,7	36,4	40,0	43,6	47,3	50,9	54,5	58,2

Characteristic load-carrying capacity $F_{5,Rk}$ (N) for one angle bracket

b / e (mm)	0	20	40	60	80	100	120	140	160	180	200	220	240	260	280	300	320	
0	T	504	1080	6615	4410	3308	2646	2205	1890	1654	1470	1323	1203	1103	1018	945	882	827
	S	90	194	1189	793	594	475	396	339	297	264	237	216	198	183	169	158	148
20	T	504	1080	6615	4410	3308	2646	2205	1890	1654	1470	1323	1203	1103	1018	945	882	827
	S	90	194	1189	793	594	475	396	339	297	264	237	216	198	183	169	158	148
40	T	504	1080	6615	4410	3308	2646	2205	1890	1654	1470	1323	1203	1103	1018	945	882	827
	S	90	194	1189	793	594	475	396	339	297	264	237	216	198	183	169	158	148
60	T	504	1080	6615	4410	3308	2646	2205	1890	1654	1470	1323	1203	1103	1018	945	882	827
	S	90	194	1189	793	594	475	396	339	297	264	237	216	198	183	169	158	148
80	T	504	1080	6615	4410	3308	2646	2205	1890	1654	1470	1323	1203	1103	1018	945	882	827
	S	90	194	1189	793	594	475	396	339	297	264	237	216	198	183	169	158	148
100	T	504	1080	6615	4410	3308	2646	2205	1890	1654	1470	1323	1203	1103	1018	945	882	827
	S	90	194	1189	793	594	475	396	339	297	264	237	216	198	183	169	158	148
120	T	504	1080	6615	4410	3308	2646	2205	1890	1654	1470	1323	1203	1103	1018	945	882	827
	S	90	194	1189	793	594	475	396	339	297	264	237	216	198	183	169	158	148
140	T	504	1080	6615	4410	3308	2646	2205	1890	1654	1470	1323	1203	1103	1018	945	882	827
	S	90	194	1189	793	594	475	396	339	297	264	237	216	198	183	169	158	148
160	T	504	1080	6615	4410	3308	2646	2205	1890	1654	1470	1323	1203	1103	1018	945	882	827
	S	90	194	1189	793	594	475	396	339	297	264	237	216	198	183	169	158	148
180	T	504	1080	6615	4410	3308	2646	2205	1890	1654	1470	1323	1203	1103	1018	945	882	827
	S	90	194	1189	793	594	475	396	339	297	264	237	216	198	183	169	158	148
200	T	504	1080	6615	4410	3308	2646	2205	1890	1654	1470	1323	1203	1103	1018	945	882	827
	S	90	194	1189	793	594	475	396	339	297	264	237	216	198	183	169	158	148
220	T	504	1080	6615	4410	3308	2646	2205	1890	1654	1470	1323	1203	1103	1018	945	882	827
	S	90	194	1189	793	594	475	396	339	297	264	237	216	198	183	169	158	148
240	T	504	1080	6615	4410	3308	2646	2205	1890	1654	1470	1323	1203	1103	1018	945	882	827
	S	90	194	1189	793	594	475	396	339	297	264	237	216	198	183	169	158	148
$k_1 \times b$ (-)		0,0	18,1	36,3	54,4	72,6	90,7	108,9	127,0	145,2	163,3	181,5	199,6	217,8	235,9	254,1	272,2	290,4

Characteristic load-carrying capacity $F_{4/5,Rk}$ (N) for two angle brackets

b / e (mm)	0	20	40	60	80	100	120	140	160	180	200	220	240	260	280	300	320	
0	T	45360	45360	45360	45360	45360	45360	45360	45360	45360	45360	45360	45360	45360	45360	45360	45360	
	S	-	-	-	-	-	-	-	-	-	-	-	-	-	-	-	-	
20	T	45360	24036	12018	8012	6009	4807	4006	3434	3005	2671	2404	2185	2003	1849	1717	1602	1502
	S	-	356	178	118	89	71	59	50	44	39	35	32	29	27	25	23	22
40	T	45360	45360	24036	16024	12018	9614	8012	6867	6009	5341	4807	4370	4006	3698	3434	3205	3005
	S	-	712	356	237	178	142	118	101	89	79	71	64	59	54	50	47	44
60	T	45360	45360	36054	24036	18027	14422	12018	10301	9014	8012	7211	6555	6009	5547	5151	4807	4507
	S	-	1068	534	356	267	213	178	152	133	118	106	97	89	82	76	71	66
80	T	45360	45360	45360	32048	24036	19229	16024	13735	12018	10683	9614	8740	8012	7396	6867	6410	6009
	S	-	1424	712	474	356	284	237	203	178	158	142	129	118	109	101	94	89
100	T	45360	45360	45360	40060	30045	24036	20030	17169	15023	13353	12018	10925	10015	9245	8584	8012	7511
	S	-	1780	890	593	445	356	296	254	222	197	178	161	148	136	127	118	111
120	T	45360	45360	45360	45360	36054	28843	24036	20602	18027	16024	14422	13111	12018	11094	10301	9614	9014
	S	-	2136	1068	712	534	427	356	305	267	237	213	194	178	164	152	142	133
140	T	45360	45360	45360	45360	42063	33650	28042	24036	21032	18695	16825	15296	14021	12942	12018	11217	10516
	S	-	2492	1246	830	623	498	415	356	311	276	249	226	207	191	178	166	155
160	T	45360	45360	45360	45360	45360	38458	32048	27470	24036	21365	19229	17481	16024	14791	13735	12819	12018
	S	-	2848	1424	949	712	569	474	406	356	316	284	258	237	219	203	189	178
180	T	45360	45360	45360	45360	45360	43265	36054	30903	27041	24036	21632	19666	18027	16640	15452	14422	13520
	S	-	3204	1602	1068	801	640	534	457	400	356	320	291	267	246	228	213	200
200	T	45360	45360	45360	45360	45360	40060	34337	30045	26707	24036	21851	20030	18489	17169	16024	15023	
	S	-	3560	1780	1186	890	712	593	508	445	395	356	323	296	273	254	237	222
220	T	45360	45360	45360	45360	45360	44066	37771	33050	29377	26440	24036	22033	20338	18885	17626	16525	
	S	-	3917	1958	1305	979	783	652	559	489	435	391	356	326	301	279	261	244
240	T	45360	45360	45360	45360	45360	45360	41205	36054	32048	28843	26221	24036	22187	20602	19229	18027	
	S	-	4273	2136	1424	1068	854	712	610	534	474	427	388	356	328	305	284	267
$k_1 \times b$ (-)		0,0	109,1	218,2	327,3	436,4	545,5	654,5	763,6	872,7	981,8	1090,9	1200,0	1309,1	1418,2	1527,3	1636,4	1745,5

TTM: Timber-Timber-Maximum | TTP: Timber-Timber-Partial | TCM: Timber-Concrete-Maximum | TCP: Timber-Concrete-Partial

T: $F_{1,T,Rk}$ load-carrying capacity of timber | S: $F_{1,S,Rk}$ load-carrying capacity of steel

Table B. 117 Angle bracket type 9004S, Variant TCM, Fastener GH Screw 5x60, Density 350 kg/m³Characteristic load-carrying capacity $F_{T,Rk}$ (N) for one / two angle brackets

angle bracket		1													2
f (mm)		0	10	20	30	40	50	60	70	80	90	100	110	120	0
$F_{T,Rk}$	T	27180	2940	1470	980	735	588	490	420	368	327	294	267	245	54360
	S	356	267	169	113	84	67	56	48	42	37	33	30	28	
k_t (-)		5,5	7,3	9,1	10,9	12,7	14,5	16,4	18,2	20,0	21,8	23,6	25,5	27,3	2,7

Characteristic load-carrying capacity $F_{2/3,Rk}$ (N) for one / two angle brackets

angle bracket		1	2
$F_{2/3,Rk}$	T	7830	15660
	S	-	-

Characteristic load-carrying capacity $F_{4,Rk}$ (N) for one angle bracket

e (mm)		0	20	40	60	80	100	120	140	160	180	200	220	240	260	280	300	320
$F_{4,Rk}$	T	-	-	11760	1307	692	470	356	287	240	206	181	161	145	132	121	112	104
	S	-	534	267	151	79	54	41	33	27	23	20	18	16	15	14	12	12
k_t (-)		0,0	3,6	7,3	10,9	14,5	18,2	21,8	25,5	29,1	32,7	36,4	40,0	43,6	47,3	50,9	54,5	58,2

Characteristic load-carrying capacity $F_{5,Rk}$ (N) for one angle bracket

b / e (mm)		0	20	40	60	80	100	120	140	160	180	200	220	240	260	280	300	320
0	T	784	1680	10290	6860	5145	4116	3430	2940	2573	2287	2058	1871	1715	1583	1470	1372	1286
	S	90	194	1189	793	594	475	396	339	297	264	237	216	198	183	169	158	148
20	T	784	1680	10290	6860	5145	4116	3430	2940	2573	2287	2058	1871	1715	1583	1470	1372	1286
	S	90	194	1189	793	594	475	396	339	297	264	237	216	198	183	169	158	148
40	T	784	1680	10290	6860	5145	4116	3430	2940	2573	2287	2058	1871	1715	1583	1470	1372	1286
	S	90	194	1189	793	594	475	396	339	297	264	237	216	198	183	169	158	148
60	T	784	1680	10290	6860	5145	4116	3430	2940	2573	2287	2058	1871	1715	1583	1470	1372	1286
	S	90	194	1189	793	594	475	396	339	297	264	237	216	198	183	169	158	148
80	T	784	1680	10290	6860	5145	4116	3430	2940	2573	2287	2058	1871	1715	1583	1470	1372	1286
	S	90	194	1189	793	594	475	396	339	297	264	237	216	198	183	169	158	148
100	T	784	1680	10290	6860	5145	4116	3430	2940	2573	2287	2058	1871	1715	1583	1470	1372	1286
	S	90	194	1189	793	594	475	396	339	297	264	237	216	198	183	169	158	148
120	T	784	1680	10290	6860	5145	4116	3430	2940	2573	2287	2058	1871	1715	1583	1470	1372	1286
	S	90	194	1189	793	594	475	396	339	297	264	237	216	198	183	169	158	148
140	T	784	1680	10290	6860	5145	4116	3430	2940	2573	2287	2058	1871	1715	1583	1470	1372	1286
	S	90	194	1189	793	594	475	396	339	297	264	237	216	198	183	169	158	148
160	T	784	1680	10290	6860	5145	4116	3430	2940	2573	2287	2058	1871	1715	1583	1470	1372	1286
	S	90	194	1189	793	594	475	396	339	297	264	237	216	198	183	169	158	148
180	T	784	1680	10290	6860	5145	4116	3430	2940	2573	2287	2058	1871	1715	1583	1470	1372	1286
	S	90	194	1189	793	594	475	396	339	297	264	237	216	198	183	169	158	148
200	T	784	1680	10290	6860	5145	4116	3430	2940	2573	2287	2058	1871	1715	1583	1470	1372	1286
	S	90	194	1189	793	594	475	396	339	297	264	237	216	198	183	169	158	148
220	T	784	1680	10290	6860	5145	4116	3430	2940	2573	2287	2058	1871	1715	1583	1470	1372	1286
	S	90	194	1189	793	594	475	396	339	297	264	237	216	198	183	169	158	148
240	T	784	1680	10290	6860	5145	4116	3430	2940	2573	2287	2058	1871	1715	1583	1470	1372	1286
	S	90	194	1189	793	594	475	396	339	297	264	237	216	198	183	169	158	148
$k_t \times b$ (-)		0,0	18,1	36,3	54,4	72,6	90,7	108,9	127,0	145,2	163,3	181,5	199,6	217,8	235,9	254,1	272,2	290,4

Characteristic load-carrying capacity $F_{4/5,Rk}$ (N) for two angle brackets

b / e (mm)		0	20	40	60	80	100	120	140	160	180	200	220	240	260	280	300	320
0	T	70560	70560	70560	70560	70560	70560	70560	70560	70560	70560	70560	70560	70560	70560	70560	70560	70560
	S	-	-	-	-	-	-	-	-	-	-	-	-	-	-	-	-	-
20	T	70560	27180	13590	9060	6795	5436	4530	3883	3398	3020	2718	2471	2265	2091	1941	1812	1699
	S	-	356	178	118	89	71	59	50	44	39	35	32	29	27	25	23	22
40	T	70560	54360	27180	18120	13590	10872	9060	7766	6795	6040	5436	4942	4530	4182	3883	3624	3398
	S	-	712	356	237	178	142	118	101	89	79	71	64	59	54	50	47	44
60	T	70560	70560	40770	27180	20385	16308	13590	11649	10193	9060	8154	7413	6795	6272	5824	5436	5096
	S	-	1068	534	356	267	213	178	152	133	118	106	97	89	82	76	71	66
80	T	70560	70560	54360	36240	27180	21744	18120	15531	13590	12080	10872	9884	9060	8363	7766	7248	6795
	S	-	1424	712	474	356	284	237	203	178	158	142	129	118	109	101	94	89
100	T	70560	70560	67950	45300	33975	27180	22650	19414	16988	15100	13590	12355	11325	10454	9707	9060	8494
	S	-	1780	890	593	445	356	296	254	222	197	178	161	148	136	127	118	111
120	T	70560	70560	70560	54360	40770	32616	27180	23297	20385	18120	16308	14825	13590	12545	11649	10872	10193
	S	-	2136	1068	712	534	427	356	305	267	237	213	194	178	164	152	142	133
140	T	70560	70560	70560	63420	47565	38052	31710	27180	23783	21140	19026	17296	15855	14635	13590	12684	11891
	S	-	2492	1246	830	623	498	415	356	311	276	249	226	207	191	178	166	155
160	T	70560	70560	70560	70560	54360	43488	36240	31063	27180	24160	21744	19767	18120	16726	15531	14496	13590
	S	-	2848	1424	949	712	569	474	406	356	316	284	258	237	219	203	189	178
180	T	70560	70560	70560	70560	61155	48924	40770	34946	30578	27180	24462	22238	20385	18817	17473	16308	15289
	S	-	3204	1602	1068	801	640	534	457	400	356	320	291	267	246	228	213	200
200	T	70560	70560	70560	70560	67950	54360	45300	38829	33975	30200	27180	24709	22650	20908	19414	18120	16988
	S	-	3560	1780	1186	890	712	593	508	445	395	356	323	296	273	254	237	222
220	T	70560	70560	70560	70560	70560	59796	49830	42711	37373	33220	29898	27180	24915	22998	21356	19932	18686
	S	-	3917	1958	1305	979	783	652	559	489	435	391	356	326	301	279	261	244
240	T	70560	70560	70560	70560	70560	65232	54360	46594	40770	36240	32616	29651	27180	25089	23297	21744	20385
	S	-	4273	2136	1424	1068	854	712	610	534	474	427	388	356	328	305	284	267
$k_t \times b$ (-)		0,0	109,1	218,2	327,3	436,4	545,5	654,5	763,6	872,7	981,8	1090,9	1200,0	1309,1	1418,2	1527,3	1636,4	1745,5

TTM: Timber-Timber-Maximum | TTP: Timber-Timber-Partial | TCM: Timber-Concrete-Maximum | TCP: Timber-Concrete-Partial

T: $F_{T,Rk}$ load-carrying capacity of timber | S: $F_{S,Rk}$ load-carrying capacity of steel

Table B. 118 Angle bracket type 9004S, Variant TCP, Fastener GH Nail 4x40, Density 350 kg/m³Characteristic load-carrying capacity $F_{T,Rk}$ (N) for one / two angle brackets

angle bracket		1													2
f (mm)		0	10	20	30	40	50	60	70	80	90	100	110	120	0
$F_{T,Rk}$	T	15120	900	450	300	225	180	150	129	113	100	90	82	75	30240
	S	356	267	169	113	84	67	56	48	42	37	33	30	28	712
k_t (-)		5,5	7,3	9,1	10,9	12,7	14,5	16,4	18,2	20,0	21,8	23,6	25,5	27,3	2,7

Characteristic load-carrying capacity $F_{2/3,Rk}$ (N) for one / two angle brackets

angle bracket		1	2
$F_{2/3,Rk}$	T	4700	9400
	S	-	-

Characteristic load-carrying capacity $F_{4,Rk}$ (N) for one angle bracket

e (mm)		0	20	40	60	80	100	120	140	160	180	200	220	240	260	280	300	320
$F_{4,Rk}$	T	-	-	3600	400	212	144	109	88	73	63	55	49	44	40	37	34	32
	S	-	534	267	151	79	54	41	33	27	23	20	18	16	15	14	12	12
k_t (-)		0,0	3,6	7,3	10,9	14,5	18,2	21,8	25,5	29,1	32,7	36,4	40,0	43,6	47,3	50,9	54,5	58,2

Characteristic load-carrying capacity $F_{5,Rk}$ (N) for one angle bracket

b / e (mm)		0	20	40	60	80	100	120	140	160	180	200	220	240	260	280	300	320
0	T	240	514	3150	2100	1575	1260	1050	900	788	700	630	573	525	485	450	420	394
	S	90	194	1189	793	594	475	396	339	297	264	237	216	198	183	169	158	148
20	T	240	514	3150	2100	1575	1260	1050	900	788	700	630	573	525	485	450	420	394
	S	90	194	1189	793	594	475	396	339	297	264	237	216	198	183	169	158	148
40	T	240	514	3150	2100	1575	1260	1050	900	788	700	630	573	525	485	450	420	394
	S	90	194	1189	793	594	475	396	339	297	264	237	216	198	183	169	158	148
60	T	240	514	3150	2100	1575	1260	1050	900	788	700	630	573	525	485	450	420	394
	S	90	194	1189	793	594	475	396	339	297	264	237	216	198	183	169	158	148
80	T	240	514	3150	2100	1575	1260	1050	900	788	700	630	573	525	485	450	420	394
	S	90	194	1189	793	594	475	396	339	297	264	237	216	198	183	169	158	148
100	T	240	514	3150	2100	1575	1260	1050	900	788	700	630	573	525	485	450	420	394
	S	90	194	1189	793	594	475	396	339	297	264	237	216	198	183	169	158	148
120	T	240	514	3150	2100	1575	1260	1050	900	788	700	630	573	525	485	450	420	394
	S	90	194	1189	793	594	475	396	339	297	264	237	216	198	183	169	158	148
140	T	240	514	3150	2100	1575	1260	1050	900	788	700	630	573	525	485	450	420	394
	S	90	194	1189	793	594	475	396	339	297	264	237	216	198	183	169	158	148
160	T	240	514	3150	2100	1575	1260	1050	900	788	700	630	573	525	485	450	420	394
	S	90	194	1189	793	594	475	396	339	297	264	237	216	198	183	169	158	148
180	T	240	514	3150	2100	1575	1260	1050	900	788	700	630	573	525	485	450	420	394
	S	90	194	1189	793	594	475	396	339	297	264	237	216	198	183	169	158	148
200	T	240	514	3150	2100	1575	1260	1050	900	788	700	630	573	525	485	450	420	394
	S	90	194	1189	793	594	475	396	339	297	264	237	216	198	183	169	158	148
220	T	240	514	3150	2100	1575	1260	1050	900	788	700	630	573	525	485	450	420	394
	S	90	194	1189	793	594	475	396	339	297	264	237	216	198	183	169	158	148
240	T	240	514	3150	2100	1575	1260	1050	900	788	700	630	573	525	485	450	420	394
	S	90	194	1189	793	594	475	396	339	297	264	237	216	198	183	169	158	148
$k_t \times b$ (-)		0,0	18,1	36,3	54,4	72,6	90,7	108,9	127,0	145,2	163,3	181,5	199,6	217,8	235,9	254,1	272,2	290,4

Characteristic load-carrying capacity $F_{4/5,Rk}$ (N) for two angle brackets

b / e (mm)		0	20	40	60	80	100	120	140	160	180	200	220	240	260	280	300	320
0	T	14400	14400	14400	14400	14400	14400	14400	14400	14400	14400	14400	14400	14400	14400	14400	14400	14400
	S	-	-	-	-	-	-	-	-	-	-	-	-	-	-	-	-	-
20	T	14400	14400	7560	5040	3780	3024	2520	2160	1890	1680	1512	1375	1260	1163	1080	1008	945
	S	-	356	178	118	89	71	59	50	44	39	35	32	29	27	25	23	22
40	T	14400	14400	14400	10080	7560	6048	5040	4320	3780	3360	3024	2749	2520	2326	2160	2016	1890
	S	-	712	356	237	178	142	118	101	89	79	71	64	59	54	50	47	44
60	T	14400	14400	14400	14400	11340	9072	7560	6480	5670	5040	4536	4124	3780	3489	3240	3024	2835
	S	-	1068	534	356	267	213	178	152	133	118	106	97	89	82	76	71	66
80	T	14400	14400	14400	14400	14400	12096	10080	8640	7560	6720	6048	5498	5040	4652	4320	4032	3780
	S	-	1424	712	474	356	284	237	203	178	158	142	129	118	109	101	94	89
100	T	14400	14400	14400	14400	14400	14400	12600	10800	9450	8400	7560	6873	6300	5815	5400	5040	4725
	S	-	1780	890	593	445	356	296	254	222	197	178	161	148	136	127	118	111
120	T	14400	14400	14400	14400	14400	14400	14400	12960	11340	10080	9072	8247	7560	6978	6480	6048	5670
	S	-	2136	1068	712	534	427	356	305	267	237	213	194	178	164	152	142	133
140	T	14400	14400	14400	14400	14400	14400	14400	14400	13230	11760	10584	9622	8820	8142	7560	7056	6615
	S	-	2492	1246	830	623	498	415	356	311	276	249	226	207	191	178	166	155
160	T	14400	14400	14400	14400	14400	14400	14400	14400	14400	13440	12096	10996	10080	9305	8640	8064	7560
	S	-	2848	1424	949	712	569	474	406	356	316	284	258	237	219	203	189	178
180	T	14400	14400	14400	14400	14400	14400	14400	14400	14400	14400	13608	12371	11340	10468	9720	9072	8505
	S	-	3204	1602	1068	801	640	534	457	400	356	320	291	267	246	228	213	200
200	T	14400	14400	14400	14400	14400	14400	14400	14400	14400	14400	14400	14400	13745	12600	11631	10800	10080
	S	-	3560	1780	1186	890	712	593	508	445	395	356	323	296	273	254	237	222
220	T	14400	14400	14400	14400	14400	14400	14400	14400	14400	14400	14400	14400	14400	13860	12794	11880	11088
	S	-	3917	1958	1305	979	783	652	559	489	435	391	356	326	301	279	261	244
240	T	14400	14400	14400	14400	14400	14400	14400	14400	14400	14400	14400	14400	14400	14400	13957	12960	12096
	S	-	4273	2136	1424	1068	854	712	610	534	474	427	388	356	328	305	284	267
$k_t \times b$ (-)		0,0	109,1	218,2	327,3	436,4	545,5	654,5	763,6	872,7	981,8	1090,9	1200,0	1309,1	1418,2	1527,3	1636,4	1745,5

TTM: Timber-Timber-Maximum | TTP: Timber-Timber-Partial | TCM: Timber-Concrete-Maximum | TCP: Timber-Concrete-Partial

T: $F_{T,Rk}$ load-carrying capacity of timber | S: $F_{S,Rk}$ load-carrying capacity of steel

Table B. 119 Angle bracket type 9004S, Variant TCP, Fastener GH Nail 4x60, Density 350 kg/m³Characteristic load-carrying capacity $F_{T,Rk}$ (N) for one / two angle brackets

angle bracket		1												2	
f (mm)		0	10	20	30	40	50	60	70	80	90	100	110	120	0
$F_{T,Rk}$	T	18912	1500	750	500	375	300	250	214	188	167	150	136	125	37824
	S	356	267	169	113	84	67	56	48	42	37	33	30	28	712
k_t (-)		5,5	7,3	9,1	10,9	12,7	14,5	16,4	18,2	20,0	21,8	23,6	25,5	27,3	2,7

Characteristic load-carrying capacity $F_{2/3,Rk}$ (N) for one / two angle brackets

angle bracket		1	2
$F_{2/3,Rk}$	T	6340	12680
	S	-	-

Characteristic load-carrying capacity $F_{4,Rk}$ (N) for one angle bracket

e (mm)		0	20	40	60	80	100	120	140	160	180	200	220	240	260	280	300	320
$F_{4,Rk}$	T	-	-	6000	667	353	240	182	146	122	105	92	82	74	67	62	57	53
	S	-	534	267	151	79	54	41	33	27	23	20	18	16	15	14	12	12
k_t (-)		0,0	3,6	7,3	10,9	14,5	18,2	21,8	25,5	29,1	32,7	36,4	40,0	43,6	47,3	50,9	54,5	58,2

Characteristic load-carrying capacity $F_{5,Rk}$ (N) for one angle bracket

b / e (mm)		0	20	40	60	80	100	120	140	160	180	200	220	240	260	280	300	320
0	T	400	857	5250	3500	2625	2100	1750	1500	1313	1167	1050	955	875	808	750	700	656
	S	90	194	1189	793	594	475	396	339	297	264	237	216	198	183	169	158	148
20	T	400	857	5250	3500	2625	2100	1750	1500	1313	1167	1050	955	875	808	750	700	656
	S	90	194	1189	793	594	475	396	339	297	264	237	216	198	183	169	158	148
40	T	400	857	5250	3500	2625	2100	1750	1500	1313	1167	1050	955	875	808	750	700	656
	S	90	194	1189	793	594	475	396	339	297	264	237	216	198	183	169	158	148
60	T	400	857	5250	3500	2625	2100	1750	1500	1313	1167	1050	955	875	808	750	700	656
	S	90	194	1189	793	594	475	396	339	297	264	237	216	198	183	169	158	148
80	T	400	857	5250	3500	2625	2100	1750	1500	1313	1167	1050	955	875	808	750	700	656
	S	90	194	1189	793	594	475	396	339	297	264	237	216	198	183	169	158	148
100	T	400	857	5250	3500	2625	2100	1750	1500	1313	1167	1050	955	875	808	750	700	656
	S	90	194	1189	793	594	475	396	339	297	264	237	216	198	183	169	158	148
120	T	400	857	5250	3500	2625	2100	1750	1500	1313	1167	1050	955	875	808	750	700	656
	S	90	194	1189	793	594	475	396	339	297	264	237	216	198	183	169	158	148
140	T	400	857	5250	3500	2625	2100	1750	1500	1313	1167	1050	955	875	808	750	700	656
	S	90	194	1189	793	594	475	396	339	297	264	237	216	198	183	169	158	148
160	T	400	857	5250	3500	2625	2100	1750	1500	1313	1167	1050	955	875	808	750	700	656
	S	90	194	1189	793	594	475	396	339	297	264	237	216	198	183	169	158	148
180	T	400	857	5250	3500	2625	2100	1750	1500	1313	1167	1050	955	875	808	750	700	656
	S	90	194	1189	793	594	475	396	339	297	264	237	216	198	183	169	158	148
200	T	400	857	5250	3500	2625	2100	1750	1500	1313	1167	1050	955	875	808	750	700	656
	S	90	194	1189	793	594	475	396	339	297	264	237	216	198	183	169	158	148
220	T	400	857	5250	3500	2625	2100	1750	1500	1313	1167	1050	955	875	808	750	700	656
	S	90	194	1189	793	594	475	396	339	297	264	237	216	198	183	169	158	148
240	T	400	857	5250	3500	2625	2100	1750	1500	1313	1167	1050	955	875	808	750	700	656
	S	90	194	1189	793	594	475	396	339	297	264	237	216	198	183	169	158	148
$k_t \times b$ (-)		0,0	18,1	36,3	54,4	72,6	90,7	108,9	127,0	145,2	163,3	181,5	199,6	217,8	235,9	254,1	272,2	290,4

Characteristic load-carrying capacity $F_{4/5,Rk}$ (N) for two angle brackets

b / e (mm)		0	20	40	60	80	100	120	140	160	180	200	220	240	260	280	300	320
0	T	23999	23999	23999	23999	23999	23999	23999	23999	23999	23999	23999	23999	23999	23999	23999	23999	23999
	S	-	-	-	-	-	-	-	-	-	-	-	-	-	-	-	-	-
20	T	23999	18912	9456	6304	4728	3782	3152	2702	2364	2101	1891	1719	1576	1455	1351	1261	1182
	S	-	356	178	118	89	71	59	50	44	39	35	32	29	27	25	23	22
40	T	23999	24000	18912	12608	9456	7565	6304	5403	4728	4203	3782	3439	3152	2910	2702	2522	2364
	S	-	712	356	237	178	142	118	101	89	79	71	64	59	54	50	47	44
60	T	23999	24000	24000	18912	14184	11347	9456	8105	7092	6304	5674	5158	4728	4364	4053	3782	3546
	S	-	1068	534	356	267	213	178	152	133	118	106	97	89	82	76	71	66
80	T	23999	24000	24000	24000	18912	15130	12608	10807	9456	8405	7565	6877	6304	5819	5403	5043	4728
	S	-	1424	712	474	356	284	237	203	178	158	142	129	118	109	101	94	89
100	T	23999	24000	24000	24000	23640	18912	15760	13509	11820	10507	9456	8596	7880	7274	6754	6304	5910
	S	-	1780	890	593	445	356	296	254	222	197	178	161	148	136	127	118	111
120	T	23999	24000	24000	24000	24000	22694	18912	16210	14184	12608	11347	10316	9456	8729	8105	7565	7092
	S	-	2136	1068	712	534	427	356	305	267	237	213	194	178	164	152	142	133
140	T	23999	24000	24000	24000	24000	22064	18912	16548	14709	13238	12035	11032	10183	9456	8826	8274	7874
	S	-	2492	1246	830	623	498	415	356	311	276	249	226	207	191	178	166	155
160	T	23999	24000	24000	24000	24000	24000	21614	18912	16811	15130	13754	12608	11638	10807	10086	9456	8956
	S	-	2848	1424	949	712	569	474	406	356	316	284	258	237	219	203	189	178
180	T	23999	24000	24000	24000	24000	24000	24000	21276	18912	17021	15473	14184	13093	12158	11347	10638	10138
	S	-	3204	1602	1068	801	640	534	457	400	356	320	291	267	246	228	213	200
200	T	23999	24000	24000	24000	24000	24000	24000	23640	21013	18912	17193	15760	14548	13509	12608	11820	11220
	S	-	3560	1780	1186	890	712	593	508	445	395	356	323	296	273	254	237	222
220	T	23999	24000	24000	24000	24000	24000	24000	24000	23115	20803	18912	17336	16002	14859	13869	13002	12402
	S	-	3917	1958	1305	979	783	652	559	489	435	391	356	326	301	279	261	244
240	T	23999	24000	24000	24000	24000	24000	24000	24000	24000	24000	22694	20631	18912	17457	16210	15130	14184
	S	-	4273	2136	1424	1068	854	712	610	534	474	427	388	356	328	305	284	267
$k_t \times b$ (-)		0,0	109,1	218,2	327,3	436,4	545,5	654,5	763,6	872,7	981,8	1090,9	1200,0	1309,1	1418,2	1527,3	1636,4	1745,5

TTM: Timber-Timber-Maximum | TTP: Timber-Timber-Partial | TCM: Timber-Concrete-Maximum | TCP: Timber-Concrete-Partial

T: $F_{T,Rk}$ load-carrying capacity of timber | S: $F_{S,Rk}$ load-carrying capacity of steel

Table B. 120 Angle bracket type 9004S, Variant TCP, Fastener GH Screw 5x40, Density 350 kg/m³Characteristic load-carrying capacity $F_{1,Rk}$ (N) for one / two angle brackets

angle bracket	1													2	
f (mm)	0	10	20	30	40	50	60	70	80	90	100	110	120	0	
$F_{1,Rk}$	T	16024	1890	945	630	473	378	315	270	236	210	189	172	158	32048
	S	356	267	169	113	84	67	56	48	42	37	33	30	28	712
k_1 (-)	5,5	7,3	9,1	10,9	12,7	14,5	16,4	18,2	20,0	21,8	23,6	25,5	27,3	2,7	

Characteristic load-carrying capacity $F_{2/3,Rk}$ (N) for one / two angle brackets

angle bracket	1	2	
$F_{2/3,Rk}$	T	5700	11400
	S	-	-

Characteristic load-carrying capacity $F_{4,Rk}$ (N) for one angle bracket

e (mm)	0	20	40	60	80	100	120	140	160	180	200	220	240	260	280	300	320	
$F_{4,Rk}$	T	-	-	7560	840	445	302	229	184	154	133	116	104	93	85	78	72	67
	S	-	534	267	151	79	54	41	33	27	23	20	18	16	15	14	12	12
k_1 (-)	0,0	3,6	7,3	10,9	14,5	18,2	21,8	25,5	29,1	32,7	36,4	40,0	43,6	47,3	50,9	54,5	58,2	

Characteristic load-carrying capacity $F_{5,Rk}$ (N) for one angle bracket

b / e (mm)	0	20	40	60	80	100	120	140	160	180	200	220	240	260	280	300	320	
0	T	504	1080	6615	4410	3308	2646	2205	1890	1654	1470	1323	1203	1103	1018	945	882	827
	S	90	194	1189	793	594	475	396	339	297	264	237	216	198	183	169	158	148
20	T	504	1080	6615	4410	3308	2646	2205	1890	1654	1470	1323	1203	1103	1018	945	882	827
	S	90	194	1189	793	594	475	396	339	297	264	237	216	198	183	169	158	148
40	T	504	1080	6615	4410	3308	2646	2205	1890	1654	1470	1323	1203	1103	1018	945	882	827
	S	90	194	1189	793	594	475	396	339	297	264	237	216	198	183	169	158	148
60	T	504	1080	6615	4410	3308	2646	2205	1890	1654	1470	1323	1203	1103	1018	945	882	827
	S	90	194	1189	793	594	475	396	339	297	264	237	216	198	183	169	158	148
80	T	504	1080	6615	4410	3308	2646	2205	1890	1654	1470	1323	1203	1103	1018	945	882	827
	S	90	194	1189	793	594	475	396	339	297	264	237	216	198	183	169	158	148
100	T	504	1080	6615	4410	3308	2646	2205	1890	1654	1470	1323	1203	1103	1018	945	882	827
	S	90	194	1189	793	594	475	396	339	297	264	237	216	198	183	169	158	148
120	T	504	1080	6615	4410	3308	2646	2205	1890	1654	1470	1323	1203	1103	1018	945	882	827
	S	90	194	1189	793	594	475	396	339	297	264	237	216	198	183	169	158	148
140	T	504	1080	6615	4410	3308	2646	2205	1890	1654	1470	1323	1203	1103	1018	945	882	827
	S	90	194	1189	793	594	475	396	339	297	264	237	216	198	183	169	158	148
160	T	504	1080	6615	4410	3308	2646	2205	1890	1654	1470	1323	1203	1103	1018	945	882	827
	S	90	194	1189	793	594	475	396	339	297	264	237	216	198	183	169	158	148
180	T	504	1080	6615	4410	3308	2646	2205	1890	1654	1470	1323	1203	1103	1018	945	882	827
	S	90	194	1189	793	594	475	396	339	297	264	237	216	198	183	169	158	148
200	T	504	1080	6615	4410	3308	2646	2205	1890	1654	1470	1323	1203	1103	1018	945	882	827
	S	90	194	1189	793	594	475	396	339	297	264	237	216	198	183	169	158	148
220	T	504	1080	6615	4410	3308	2646	2205	1890	1654	1470	1323	1203	1103	1018	945	882	827
	S	90	194	1189	793	594	475	396	339	297	264	237	216	198	183	169	158	148
240	T	504	1080	6615	4410	3308	2646	2205	1890	1654	1470	1323	1203	1103	1018	945	882	827
	S	90	194	1189	793	594	475	396	339	297	264	237	216	198	183	169	158	148
$k_1 \times b$ (-)	0,0	18,1	36,3	54,4	72,6	90,7	108,9	127,0	145,2	163,3	181,5	199,6	217,8	235,9	254,1	272,2	290,4	

Characteristic load-carrying capacity $F_{4/5,Rk}$ (N) for two angle brackets

b / e (mm)	0	20	40	60	80	100	120	140	160	180	200	220	240	260	280	300	320	
0	T	30239	30239	30239	30239	30239	30239	30239	30239	30239	30239	30239	30239	30239	30239	30239	30239	
	S	-	-	-	-	-	-	-	-	-	-	-	-	-	-	-	-	
20	T	30239	16024	8012	5341	4006	3205	2671	2289	2003	1780	1602	1457	1335	1233	1145	1068	1002
	S	-	356	178	118	89	71	59	50	44	39	35	32	29	27	25	23	22
40	T	30239	30240	16024	10683	8012	6410	5341	4578	4006	3561	3205	2913	2671	2465	2289	2137	2003
	S	-	712	356	237	178	142	118	101	89	79	71	64	59	54	50	47	44
60	T	30239	30240	24036	16024	12018	9614	8012	6867	6009	5341	4807	4370	4006	3698	3434	3205	3005
	S	-	1068	534	356	267	213	178	152	133	118	106	97	89	82	76	71	66
80	T	30239	30240	30240	21365	16024	12819	10683	9157	8012	7122	6410	5827	5341	4930	4578	4273	4006
	S	-	1424	712	474	356	284	237	203	178	158	142	129	118	109	101	94	89
100	T	30239	30240	30240	26707	20030	16024	13353	11446	10015	8902	8012	7284	6677	6163	5723	5341	5008
	S	-	1780	890	593	445	356	296	254	222	197	178	161	148	136	127	118	111
120	T	30239	30240	30240	30240	24036	19229	16024	13735	12018	10683	9614	8740	8012	7396	6867	6410	6009
	S	-	2136	1068	712	534	427	356	305	267	237	213	194	178	164	152	142	133
140	T	30239	30240	30240	30240	28042	22434	18695	16024	14021	12463	11217	10197	9347	8628	8012	7478	7011
	S	-	2492	1246	830	623	498	415	356	311	276	249	226	207	191	178	166	155
160	T	30239	30240	30240	30240	30240	25638	21365	18313	16024	14244	12819	11654	10683	9861	9157	8546	8012
	S	-	2848	1424	949	712	569	474	406	356	316	284	258	237	219	203	189	178
180	T	30239	30240	30240	30240	30240	28843	24036	20602	18027	16024	14422	13111	12018	11094	10301	9614	9014
	S	-	3204	1602	1068	801	640	534	457	400	356	320	291	267	246	228	213	200
200	T	30239	30240	30240	30240	30240	26707	22891	20030	17804	16024	14567	13353	12326	11446	10683	10015	9478
	S	-	3560	1780	1186	890	712	593	508	445	395	356	323	296	273	254	237	222
220	T	30239	30240	30240	30240	30240	29377	25181	22033	19585	17626	16024	14689	13559	12590	11751	11017	10478
	S	-	3917	1958	1305	979	783	652	559	489	435	391	356	326	301	279	261	244
240	T	30239	30240	30240	30240	30240	30240	30240	27470	24036	21365	19229	17481	16024	14791	13735	12819	12018
	S	-	4273	2136	1424	1068	854	712	610	534	474	427	388	356	328	305	284	267
$k_1 \times b$ (-)	0,0	109,1	218,2	327,3	436,4	545,5	654,5	763,6	872,7	981,8	1090,9	1200,0	1309,1	1418,2	1527,3	1636,4	1745,5	

TTM: Timber-Timber-Maximum | TTP: Timber-Timber-Partial | TCM: Timber-Concrete-Maximum | TCP: Timber-Concrete-Partial

T: $F_{1,T,Rk}$ load-carrying capacity of timber | S: $F_{1,S,Rk}$ load-carrying capacity of steel

Table B. 121 Angle bracket type 9004S, Variant TCP, Fastener GH Screw 5x60, Density 350 kg/m³Characteristic load-carrying capacity $F_{1,Rk}$ (N) for one / two angle brackets

angle bracket	1													2	
f (mm)	0	10	20	30	40	50	60	70	80	90	100	110	120	0	
$F_{1,Rk}$	T	18120	2940	1470	980	735	588	490	420	368	327	294	267	245	36240
	S	356	267	169	113	84	67	56	48	42	37	33	30	28	712
k_1 (-)	5,5	7,3	9,1	10,9	12,7	14,5	16,4	18,2	20,0	21,8	23,6	25,5	27,3	2,7	

Characteristic load-carrying capacity $F_{2/3,Rk}$ (N) for one / two angle brackets

angle bracket	1	2	
$F_{2/3,Rk}$	T	6610	13220
	S	-	-

Characteristic load-carrying capacity $F_{4,Rk}$ (N) for one angle bracket

e (mm)	0	20	40	60	80	100	120	140	160	180	200	220	240	260	280	300	320	
$F_{4,Rk}$	T	-	-	11760	1307	692	470	356	287	240	206	181	161	145	132	121	112	104
	S	-	534	267	151	79	54	41	33	27	23	20	18	16	15	14	12	12
k_1 (-)	0,0	3,6	7,3	10,9	14,5	18,2	21,8	25,5	29,1	32,7	36,4	40,0	43,6	47,3	50,9	54,5	58,2	

Characteristic load-carrying capacity $F_{5,Rk}$ (N) for one angle bracket

b / e (mm)	0	20	40	60	80	100	120	140	160	180	200	220	240	260	280	300	320	
0	T	784	1680	10290	6860	5145	4116	3430	2940	2573	2287	2058	1871	1715	1583	1470	1372	1286
	S	90	194	1189	793	594	475	396	339	297	264	237	216	198	183	169	158	148
20	T	784	1680	9060	6040	4530	3624	3020	2589	2265	2013	1812	1647	1510	1394	1294	1208	1133
	S	90	194	1189	793	594	475	396	339	297	264	237	216	198	183	169	158	148
40	T	784	1680	10290	6860	5145	4116	3430	2940	2573	2287	2058	1871	1715	1583	1470	1372	1286
	S	90	194	1189	793	594	475	396	339	297	264	237	216	198	183	169	158	148
60	T	784	1680	10290	6860	5145	4116	3430	2940	2573	2287	2058	1871	1715	1583	1470	1372	1286
	S	90	194	1189	793	594	475	396	339	297	264	237	216	198	183	169	158	148
80	T	784	1680	10290	6860	5145	4116	3430	2940	2573	2287	2058	1871	1715	1583	1470	1372	1286
	S	90	194	1189	793	594	475	396	339	297	264	237	216	198	183	169	158	148
100	T	784	1680	10290	6860	5145	4116	3430	2940	2573	2287	2058	1871	1715	1583	1470	1372	1286
	S	90	194	1189	793	594	475	396	339	297	264	237	216	198	183	169	158	148
120	T	784	1680	10290	6860	5145	4116	3430	2940	2573	2287	2058	1871	1715	1583	1470	1372	1286
	S	90	194	1189	793	594	475	396	339	297	264	237	216	198	183	169	158	148
140	T	784	1680	10290	6860	5145	4116	3430	2940	2573	2287	2058	1871	1715	1583	1470	1372	1286
	S	90	194	1189	793	594	475	396	339	297	264	237	216	198	183	169	158	148
160	T	784	1680	10290	6860	5145	4116	3430	2940	2573	2287	2058	1871	1715	1583	1470	1372	1286
	S	90	194	1189	793	594	475	396	339	297	264	237	216	198	183	169	158	148
180	T	784	1680	10290	6860	5145	4116	3430	2940	2573	2287	2058	1871	1715	1583	1470	1372	1286
	S	90	194	1189	793	594	475	396	339	297	264	237	216	198	183	169	158	148
200	T	784	1680	10290	6860	5145	4116	3430	2940	2573	2287	2058	1871	1715	1583	1470	1372	1286
	S	90	194	1189	793	594	475	396	339	297	264	237	216	198	183	169	158	148
220	T	784	1680	10290	6860	5145	4116	3430	2940	2573	2287	2058	1871	1715	1583	1470	1372	1286
	S	90	194	1189	793	594	475	396	339	297	264	237	216	198	183	169	158	148
240	T	784	1680	10290	6860	5145	4116	3430	2940	2573	2287	2058	1871	1715	1583	1470	1372	1286
	S	90	194	1189	793	594	475	396	339	297	264	237	216	198	183	169	158	148
$k_1 \times b$ (-)	0,0	18,1	36,3	54,4	72,6	90,7	108,9	127,0	145,2	163,3	181,5	199,6	217,8	235,9	254,1	272,2	290,4	

Characteristic load-carrying capacity $F_{4/5,Rk}$ (N) for two angle brackets

b / e (mm)	0	20	40	60	80	100	120	140	160	180	200	220	240	260	280	300	320	
0	T	47040	47040	47040	47040	47040	47040	47040	47040	47040	47040	47040	47040	47040	47040	47040	47040	
	S	-	-	-	-	-	-	-	-	-	-	-	-	-	-	-	-	
20	T	47040	18120	9060	6040	4530	3624	3020	2589	2265	2013	1812	1647	1510	1394	1294	1208	1133
	S	-	356	178	118	89	71	59	50	44	39	35	32	29	27	25	23	22
40	T	47040	36240	18120	12080	9060	7248	6040	5177	4530	4027	3624	3295	3020	2788	2589	2416	2265
	S	-	712	356	237	178	142	118	101	89	79	71	64	59	54	50	47	44
60	T	47040	47040	27180	18120	13590	10872	9060	7766	6795	6040	5436	4942	4530	4182	3883	3624	3398
	S	-	1068	534	356	267	213	178	152	133	118	106	97	89	82	76	71	66
80	T	47040	47040	36240	24160	18120	14496	12080	10354	9060	8053	7248	6589	6040	5575	5177	4832	4530
	S	-	1424	712	474	356	284	237	203	178	158	142	129	118	109	101	94	89
100	T	47040	47040	45300	30200	22650	18120	15100	12943	11325	10067	9060	8236	7550	6969	6471	6040	5663
	S	-	1780	890	593	445	356	296	254	222	197	178	161	148	136	127	118	111
120	T	47040	47040	47040	36240	27180	21744	18120	15531	13590	12080	10872	9884	9060	8363	7766	7248	6795
	S	-	2136	1068	712	534	427	356	305	267	237	213	194	178	164	152	142	133
140	T	47040	47040	47040	42280	31710	25368	21140	18120	15855	14093	12684	11531	10570	9757	9060	8456	7928
	S	-	2492	1246	830	623	498	415	356	311	276	249	226	207	191	178	166	155
160	T	47040	47040	47040	47040	36240	28992	24160	20709	18120	16107	14496	13178	12080	11151	10354	9664	9060
	S	-	2848	1424	949	712	569	474	406	356	316	284	258	237	219	203	189	178
180	T	47040	47040	47040	47040	40770	32616	27180	23297	20385	18120	16308	14825	13590	12545	11649	10872	10193
	S	-	3204	1602	1068	801	640	534	457	400	356	320	291	267	246	228	213	200
200	T	47040	47040	47040	47040	45300	36240	30200	25886	22650	20133	18120	16473	15100	13938	12943	12080	11325
	S	-	3560	1780	1186	890	712	593	508	445	395	356	323	296	273	254	237	222
220	T	47040	47040	47040	47040	47040	39864	33220	28474	24915	22147	19932	18120	16610	15332	14237	13288	12458
	S	-	3917	1958	1305	979	783	652	559	489	435	391	356	326	301	279	261	244
240	T	47040	47040	47040	47040	47040	43488	36240	31063	27180	24160	21744	19767	18120	16726	15531	14496	13590
	S	-	4273	2136	1424	1068	854	712	610	534	474	427	388	356	328	305	284	267
$k_1 \times b$ (-)	0,0	109,1	218,2	327,3	436,4	545,5	654,5	763,6	872,7	981,8	1090,9	1200,0	1309,1	1418,2	1527,3	1636,4	1745,5	

TTM: Timber-Timber-Maximum | TTP: Timber-Timber-Partial | TCM: Timber-Concrete-Maximum | TCP: Timber-Concrete-Partial

T: $F_{1,T,Rk}$ load-carrying capacity of timber | S: $F_{1,S,Rk}$ load-carrying capacity of steel

Table B. 122 Angle bracket type 9004S, Variant TTM, Fastener GH Nail 4x40, Density 350 kg/m³Characteristic load-carrying capacity $F_{T,Rk}$ (N) for one / two angle brackets

angle bracket		1													2
f (mm)		0	10	20	30	40	50	60	70	80	90	100	110	120	0
$F_{T,Rk}$	T	224	149	112	89	74	64	56	50	45	41	38	35	32	448
	S	340	227	170	113	85	68	57	48	42	37	33	30	28	680

Characteristic load-carrying capacity $F_{2/3,Rk}$ (N) for one / two angle brackets

angle bracket		1	2
$F_{2/3,Rk}$	T	8690	17380
	S	-	-

Characteristic load-carrying capacity $F_{4,Rk}$ (N) for one angle bracket

e (mm)		0	20	40	60	80	100	120	140	160	180	200	220	240	260	280	300	320
$F_{4,Rk}$	T	26459	224	112	74	56	44	37	32	28	25	23	20	19	17	16	15	14
	S	-	340	170	113	80	54	41	33	27	23	20	18	16	15	14	12	12

Characteristic load-carrying capacity $F_{5,Rk}$ (N) for one angle bracket

b / e (mm)		0	20	40	60	80	100	120	140	160	180	200	220	240	260	280	300	320
0	T	240	514	787	524	393	314	262	224	196	174	157	143	131	121	112	104	98
	S	90	194	1190	793	595	476	397	340	297	264	238	216	198	183	170	159	149
20	T	240	514	1688	1125	844	675	563	482	422	375	338	307	281	260	241	225	211
	S	90	194	1189	793	594	475	396	339	297	264	237	216	198	183	169	158	148
40	T	240	514	2588	1725	1294	1035	863	739	647	575	518	470	431	398	370	345	323
	S	90	194	1189	793	594	475	396	339	297	264	237	216	198	183	169	158	148
60	T	240	514	3150	2100	1575	1260	1050	900	788	700	630	573	525	485	450	420	394
	S	90	194	1189	793	594	475	396	339	297	264	237	216	198	183	169	158	148
80	T	240	514	3150	2100	1575	1260	1050	900	788	700	630	573	525	485	450	420	394
	S	90	194	1189	793	594	475	396	339	297	264	237	216	198	183	169	158	148
100	T	240	514	3150	2100	1575	1260	1050	900	788	700	630	573	525	485	450	420	394
	S	90	194	1189	793	594	475	396	339	297	264	237	216	198	183	169	158	148
120	T	240	514	3150	2100	1575	1260	1050	900	788	700	630	573	525	485	450	420	394
	S	90	194	1189	793	594	475	396	339	297	264	237	216	198	183	169	158	148
140	T	240	514	3150	2100	1575	1260	1050	900	788	700	630	573	525	485	450	420	394
	S	90	194	1189	793	594	475	396	339	297	264	237	216	198	183	169	158	148
160	T	240	514	3150	2100	1575	1260	1050	900	788	700	630	573	525	485	450	420	394
	S	90	194	1189	793	594	475	396	339	297	264	237	216	198	183	169	158	148
180	T	240	514	3150	2100	1575	1260	1050	900	788	700	630	573	525	485	450	420	394
	S	90	194	1189	793	594	475	396	339	297	264	237	216	198	183	169	158	148
200	T	240	514	3150	2100	1575	1260	1050	900	788	700	630	573	525	485	450	420	394
	S	90	194	1189	793	594	475	396	339	297	264	237	216	198	183	169	158	148
220	T	240	514	3150	2100	1575	1260	1050	900	788	700	630	573	525	485	450	420	394
	S	90	194	1189	793	594	475	396	339	297	264	237	216	198	183	169	158	148
240	T	240	514	3150	2100	1575	1260	1050	900	788	700	630	573	525	485	450	420	394
	S	90	194	1189	793	594	475	396	339	297	264	237	216	198	183	169	158	148

Characteristic load-carrying capacity $F_{4/5,Rk}$ (N) for two angle brackets

b / e (mm)		0	20	40	60	80	100	120	140	160	180	200	220	240	260	280	300	320
0	T	21599	21599	21599	21599	21599	21599	21599	21599	21599	21599	21599	21599	21599	21599	21599	21599	21599
	S	-	-	-	-	-	-	-	-	-	-	-	-	-	-	-	-	-
20	T	21599	224	112	74	56	44	37	32	28	24	22	20	18	17	16	14	14
	S	-	340	170	113	85	68	57	49	42	38	34	31	28	26	24	23	21
40	T	21599	449	224	149	112	89	74	64	56	49	44	40	37	34	32	29	28
	S	-	680	340	227	170	136	113	97	85	76	68	62	57	52	49	45	42
60	T	21599	674	337	224	168	134	112	96	84	74	67	61	56	51	48	44	42
	S	-	1020	510	340	255	204	170	146	127	113	102	93	85	78	73	68	64
80	T	21599	899	449	299	224	179	149	128	112	99	89	81	74	69	64	59	56
	S	-	1360	680	453	340	272	227	194	170	151	136	124	113	105	97	91	85
100	T	21599	1124	562	374	281	224	187	160	140	124	112	102	93	86	80	74	70
	S	-	1700	850	567	425	340	283	243	212	189	170	155	142	131	121	113	106
120	T	21599	1349	674	449	337	269	224	192	168	149	134	122	112	103	96	89	84
	S	-	2039	1020	680	510	408	340	291	255	227	204	185	170	157	146	136	127
140	T	21599	1574	787	524	393	314	262	224	196	174	157	143	131	121	112	104	98
	S	-	2379	1190	793	595	476	397	340	297	264	238	216	198	183	170	159	149
160	T	21599	1798	899	599	449	359	299	257	224	199	179	163	149	138	128	119	112
	S	-	2719	1360	906	680	544	453	388	340	302	272	247	227	209	194	181	170
180	T	21599	2023	1012	674	506	404	337	289	253	224	202	184	168	155	144	134	126
	S	-	3059	1530	1020	765	612	510	437	382	340	306	278	255	235	219	204	191
200	T	21599	2247	1124	749	562	449	374	321	281	249	224	204	187	173	160	149	140
	S	-	3399	1700	1133	850	680	567	486	425	378	340	309	283	261	243	227	212
220	T	21599	2472	1237	824	618	494	412	353	309	274	247	224	206	190	176	164	154
	S	-	3739	1870	1246	935	748	623	534	467	415	374	340	312	288	267	249	234
240	T	21599	2696	1349	899	674	539	449	385	337	299	269	245	224	207	192	179	168
	S	-	4079	2039	1360	1020	816	680	583	510	453	408	371	340	314	291	272	255

TTM: Timber-Timber-Maximum | TTP: Timber-Timber-Partial | TCM: Timber-Concrete-Maximum | TCP: Timber-Concrete-Partial

T: $F_{T,Rk}$ load-carrying capacity of timber | S: $F_{S,Rk}$ load-carrying capacity of steel

Table B. 123 Angle bracket type 9004S, Variant TTM, Fastener GH Nail 4x60, Density 350 kg/m³Characteristic load-carrying capacity $F_{T,Rk}$ (N) for one / two angle brackets

angle bracket		1													2
f (mm)		0	10	20	30	40	50	60	70	80	90	100	110	120	0
$F_{T,Rk}$	T	375	250	188	150	125	107	94	83	75	68	63	58	54	750
	S	339	226	169	113	84	67	56	48	42	37	33	30	28	678

Characteristic load-carrying capacity $F_{2/3,Rk}$ (N) for one / two angle brackets

angle bracket		1	2
$F_{2/3,Rk}$	T	11100	22200
	S	-	-

Characteristic load-carrying capacity $F_{4,Rk}$ (N) for one angle bracket

e (mm)		0	20	40	60	80	100	120	140	160	180	200	220	240	260	280	300	320
$F_{4,Rk}$	T	33095	375	188	125	94	75	63	54	47	42	38	34	31	29	27	25	23
	S	-	339	169	113	79	54	41	33	27	23	20	18	16	15	14	12	12

Characteristic load-carrying capacity $F_{5,Rk}$ (N) for one angle bracket

b / e (mm)		0	20	40	60	80	100	120	140	160	180	200	220	240	260	280	300	320
0	T	400	857	1313	875	656	525	438	375	328	292	263	239	219	202	188	175	164
	S	90	194	1189	793	594	475	396	339	297	264	237	216	198	183	169	158	148
20	T	400	857	2813	1875	1406	1125	938	804	703	625	563	511	469	433	402	375	352
	S	90	194	1189	793	594	475	396	339	297	264	237	216	198	183	169	158	148
40	T	400	857	4313	2875	2156	1725	1438	1232	1078	958	863	784	719	663	616	575	539
	S	90	194	1189	793	594	475	396	339	297	264	237	216	198	183	169	158	148
60	T	400	857	5250	3500	2625	2100	1750	1500	1313	1167	1050	955	875	808	750	700	656
	S	90	194	1189	793	594	475	396	339	297	264	237	216	198	183	169	158	148
80	T	400	857	5250	3500	2625	2100	1750	1500	1313	1167	1050	955	875	808	750	700	656
	S	90	194	1189	793	594	475	396	339	297	264	237	216	198	183	169	158	148
100	T	400	857	5250	3500	2625	2100	1750	1500	1313	1167	1050	955	875	808	750	700	656
	S	90	194	1189	793	594	475	396	339	297	264	237	216	198	183	169	158	148
120	T	400	857	5250	3500	2625	2100	1750	1500	1313	1167	1050	955	875	808	750	700	656
	S	90	194	1189	793	594	475	396	339	297	264	237	216	198	183	169	158	148
140	T	400	857	5250	3500	2625	2100	1750	1500	1313	1167	1050	955	875	808	750	700	656
	S	90	194	1189	793	594	475	396	339	297	264	237	216	198	183	169	158	148
160	T	400	857	5250	3500	2625	2100	1750	1500	1313	1167	1050	955	875	808	750	700	656
	S	90	194	1189	793	594	475	396	339	297	264	237	216	198	183	169	158	148
180	T	400	857	5250	3500	2625	2100	1750	1500	1313	1167	1050	955	875	808	750	700	656
	S	90	194	1189	793	594	475	396	339	297	264	237	216	198	183	169	158	148
200	T	400	857	5250	3500	2625	2100	1750	1500	1313	1167	1050	955	875	808	750	700	656
	S	90	194	1189	793	594	475	396	339	297	264	237	216	198	183	169	158	148
220	T	400	857	5250	3500	2625	2100	1750	1500	1313	1167	1050	955	875	808	750	700	656
	S	90	194	1189	793	594	475	396	339	297	264	237	216	198	183	169	158	148
240	T	400	857	5250	3500	2625	2100	1750	1500	1313	1167	1050	955	875	808	750	700	656
	S	90	194	1189	793	594	475	396	339	297	264	237	216	198	183	169	158	148

Characteristic load-carrying capacity $F_{4/5,Rk}$ (N) for two angle brackets

b / e (mm)		0	20	40	60	80	100	120	140	160	180	200	220	240	260	280	300	320
0	T	35999	35999	35999	35999	35999	35999	35999	35999	35999	35999	35999	35999	35999	35999	35999	35999	35999
	S	-	-	-	-	-	-	-	-	-	-	-	-	-	-	-	-	-
20	T	35999	375	188	125	94	75	63	54	47	42	38	34	31	29	27	25	23
	S	-	339	169	113	84	67	56	48	42	37	33	30	28	26	24	22	21
40	T	35999	750	375	250	188	150	125	107	94	83	75	68	63	58	54	50	47
	S	-	679	339	226	169	135	113	97	84	75	67	61	56	52	48	45	42
60	T	35999	1125	563	375	281	225	188	161	141	125	113	102	94	87	80	75	70
	S	-	1019	509	339	254	203	169	145	127	113	101	92	84	78	72	67	63
80	T	35999	1500	750	500	375	300	250	214	188	167	150	136	125	115	107	100	94
	S	-	1359	679	453	339	271	226	194	169	151	135	123	113	104	97	90	84
100	T	35999	1875	938	625	469	375	313	268	234	208	188	170	156	144	134	125	117
	S	-	1699	849	566	424	339	283	242	212	188	169	154	141	130	121	113	106
120	T	35999	2250	1125	750	563	450	375	321	281	250	225	205	188	173	161	150	141
	S	-	2039	1019	679	509	407	339	291	254	226	203	185	169	156	145	135	127
140	T	35999	2625	1313	875	656	525	438	375	328	292	263	239	219	202	188	175	164
	S	-	2379	1189	793	594	475	396	339	297	264	237	216	198	183	169	158	148
160	T	35999	3000	1500	1000	750	600	500	429	375	333	300	273	250	231	214	200	188
	S	-	2719	1359	906	679	543	453	388	339	302	271	247	226	209	194	181	169
180	T	35999	3375	1688	1125	844	675	563	482	422	375	338	307	281	260	241	225	211
	S	-	3059	1529	1019	764	611	509	437	382	339	305	278	254	235	218	203	191
200	T	35999	3750	1875	1250	938	750	625	536	469	417	375	341	313	288	268	250	234
	S	-	3399	1699	1133	849	679	566	485	424	377	339	309	283	261	242	226	212
220	T	35999	4125	2063	1375	1031	825	688	589	516	458	413	375	344	317	295	275	258
	S	-	3739	1869	1246	934	747	623	534	467	415	373	339	311	287	267	249	233
240	T	35999	4500	2250	1500	1125	900	750	643	563	500	450	409	375	346	321	300	281
	S	-	4078	2039	1359	1019	815	679	582	509	453	407	370	339	313	291	271	254

TTM: Timber-Timber-Maximum | TTP: Timber-Timber-Partial | TCM: Timber-Concrete-Maximum | TCP: Timber-Concrete-Partial

T: $F_{T,Rk}$ load-carrying capacity of timber | S: $F_{S,Rk}$ load-carrying capacity of steel

Table B. 124 Angle bracket type 9004S, Variant TTM, Fastener GH Screw 5x40, Density 350 kg/m³Characteristic load-carrying capacity $F_{T,Rk}$ (N) for one / two angle brackets

angle bracket		1													2
f (mm)		0	10	20	30	40	50	60	70	80	90	100	110	120	0
$F_{T,Rk}$	T	473	315	236	189	158	135	118	105	95	86	79	73	68	945
	S	339	226	169	113	84	67	56	48	42	37	33	30	28	678

Characteristic load-carrying capacity $F_{2/3,Rk}$ (N) for one / two angle brackets

angle bracket		1	2
$F_{2/3,Rk}$	T	9610	19220
	S	-	-

Characteristic load-carrying capacity $F_{4,Rk}$ (N) for one angle bracket

e (mm)		0	20	40	60	80	100	120	140	160	180	200	220	240	260	280	300	320
$F_{4,Rk}$	T	28041	473	236	158	118	95	79	68	59	53	47	43	39	36	34	32	30
	S	-	339	169	113	79	54	41	33	27	23	20	18	16	15	14	12	12

Characteristic load-carrying capacity $F_{5,Rk}$ (N) for one angle bracket

b / e (mm)		0	20	40	60	80	100	120	140	160	180	200	220	240	260	280	300	320
0	T	504	1080	1654	1103	827	662	551	473	413	368	331	301	276	254	236	221	207
	S	90	194	1189	793	594	475	396	339	297	264	237	216	198	183	169	158	148
20	T	504	1080	3544	2363	1772	1418	1181	1013	886	788	709	644	591	545	506	473	443
	S	90	194	1189	793	594	475	396	339	297	264	237	216	198	183	169	158	148
40	T	504	1080	5434	3623	2717	2174	1811	1553	1358	1208	1087	988	906	836	776	725	679
	S	90	194	1189	793	594	475	396	339	297	264	237	216	198	183	169	158	148
60	T	504	1080	6615	4410	3308	2646	2205	1890	1654	1470	1323	1203	1103	1018	945	882	827
	S	90	194	1189	793	594	475	396	339	297	264	237	216	198	183	169	158	148
80	T	504	1080	6615	4410	3308	2646	2205	1890	1654	1470	1323	1203	1103	1018	945	882	827
	S	90	194	1189	793	594	475	396	339	297	264	237	216	198	183	169	158	148
100	T	504	1080	6615	4410	3308	2646	2205	1890	1654	1470	1323	1203	1103	1018	945	882	827
	S	90	194	1189	793	594	475	396	339	297	264	237	216	198	183	169	158	148
120	T	504	1080	6615	4410	3308	2646	2205	1890	1654	1470	1323	1203	1103	1018	945	882	827
	S	90	194	1189	793	594	475	396	339	297	264	237	216	198	183	169	158	148
140	T	504	1080	6615	4410	3308	2646	2205	1890	1654	1470	1323	1203	1103	1018	945	882	827
	S	90	194	1189	793	594	475	396	339	297	264	237	216	198	183	169	158	148
160	T	504	1080	6615	4410	3308	2646	2205	1890	1654	1470	1323	1203	1103	1018	945	882	827
	S	90	194	1189	793	594	475	396	339	297	264	237	216	198	183	169	158	148
180	T	504	1080	6615	4410	3308	2646	2205	1890	1654	1470	1323	1203	1103	1018	945	882	827
	S	90	194	1189	793	594	475	396	339	297	264	237	216	198	183	169	158	148
200	T	504	1080	6615	4410	3308	2646	2205	1890	1654	1470	1323	1203	1103	1018	945	882	827
	S	90	194	1189	793	594	475	396	339	297	264	237	216	198	183	169	158	148
220	T	504	1080	6615	4410	3308	2646	2205	1890	1654	1470	1323	1203	1103	1018	945	882	827
	S	90	194	1189	793	594	475	396	339	297	264	237	216	198	183	169	158	148
240	T	504	1080	6615	4410	3308	2646	2205	1890	1654	1470	1323	1203	1103	1018	945	882	827
	S	90	194	1189	793	594	475	396	339	297	264	237	216	198	183	169	158	148

Characteristic load-carrying capacity $F_{4/5,Rk}$ (N) for two angle brackets

b / e (mm)		0	20	40	60	80	100	120	140	160	180	200	220	240	260	280	300	320
0	T	45360	45360	45360	45360	45360	45360	45360	45360	45360	45360	45360	45360	45360	45360	45360	45360	45360
	S	-	-	-	-	-	-	-	-	-	-	-	-	-	-	-	-	-
20	T	45360	473	236	158	118	95	79	68	59	53	47	43	39	36	34	32	30
	S	-	339	169	113	84	67	56	48	42	37	33	30	28	26	24	22	21
40	T	45360	945	473	315	236	189	158	135	118	105	95	86	79	73	68	63	59
	S	-	679	339	226	169	135	113	97	84	75	67	61	56	52	48	45	42
60	T	45360	1418	709	473	354	284	236	203	177	158	142	129	118	109	101	95	89
	S	-	1019	509	339	254	203	169	145	127	113	101	92	84	78	72	67	63
80	T	45360	1890	945	630	473	378	315	270	236	210	189	172	158	145	135	126	118
	S	-	1359	679	453	339	271	226	194	169	151	135	123	113	104	97	90	84
100	T	45360	2363	1181	788	591	473	394	338	295	263	236	215	197	182	169	158	148
	S	-	1699	849	566	424	339	283	242	212	188	169	154	141	130	121	113	106
120	T	45360	2835	1418	945	709	567	473	405	354	315	284	258	236	218	203	189	177
	S	-	2039	1019	679	509	407	339	291	254	226	203	185	169	156	145	135	127
140	T	45360	3308	1654	1103	827	662	551	473	413	368	331	301	276	254	236	221	207
	S	-	2379	1189	793	594	475	396	339	297	264	237	216	198	183	169	158	148
160	T	45360	3780	1890	1260	945	756	630	540	473	420	378	344	315	291	270	252	236
	S	-	2719	1359	906	679	543	453	388	339	302	271	247	226	209	194	181	169
180	T	45360	4253	2126	1418	1063	851	709	608	532	473	425	387	354	327	304	284	266
	S	-	3059	1529	1019	764	611	509	437	382	339	305	278	254	235	218	203	191
200	T	45360	4725	2363	1575	1181	945	788	675	591	525	473	430	394	363	338	315	295
	S	-	3399	1699	1133	849	679	566	485	424	377	339	309	283	261	242	226	212
220	T	45360	5198	2599	1733	1299	1040	866	743	650	578	520	473	433	400	371	347	325
	S	-	3739	1869	1246	934	747	623	534	467	415	373	339	311	287	267	249	233
240	T	45360	5670	2835	1890	1418	1134	945	810	709	630	567	515	473	436	405	378	354
	S	-	4078	2039	1359	1019	815	679	582	509	453	407	370	339	313	291	271	254

TTM: Timber-Timber-Maximum | TTP: Timber-Timber-Partial | TCM: Timber-Concrete-Maximum | TCP: Timber-Concrete-Partial

T: $F_{T,Rk}$ load-carrying capacity of timber | S: $F_{S,Rk}$ load-carrying capacity of steel

Table B. 125 Angle bracket type 9004S, Variant TTM, Fastener GH Screw 5x60, Density 350 kg/m³Characteristic load-carrying capacity $F_{T,Rk}$ (N) for one / two angle brackets

angle bracket		1													2
f (mm)		0	10	20	30	40	50	60	70	80	90	100	110	120	0
$F_{T,Rk}$	T	735	490	368	294	245	210	184	163	147	134	123	113	105	1470
	S	339	226	169	113	84	67	56	48	42	37	33	30	28	678

Characteristic load-carrying capacity $F_{2/3,Rk}$ (N) for one / two angle brackets

angle bracket		1	2
$F_{2/3,Rk}$	T	10990	21980
	S	-	-

Characteristic load-carrying capacity $F_{4,Rk}$ (N) for one angle bracket

e (mm)		0	20	40	60	80	100	120	140	160	180	200	220	240	260	280	300	320
$F_{4,Rk}$	T	31709	735	368	245	184	147	123	105	92	82	74	67	61	57	53	49	46
	S	-	339	169	113	79	54	41	33	27	23	20	18	16	15	14	12	12

Characteristic load-carrying capacity $F_{5,Rk}$ (N) for one angle bracket

b / e (mm)		0	20	40	60	80	100	120	140	160	180	200	220	240	260	280	300	320
0	T	784	1680	2573	1715	1286	1029	858	735	643	572	515	468	429	396	368	343	322
	S	90	194	1189	793	594	475	396	339	297	264	237	216	198	183	169	158	148
20	T	784	1680	5513	3675	2756	2205	1838	1575	1378	1225	1103	1002	919	848	788	735	689
	S	90	194	1189	793	594	475	396	339	297	264	237	216	198	183	169	158	148
40	T	784	1680	8453	5635	4226	3381	2818	2415	2113	1878	1691	1537	1409	1300	1208	1127	1057
	S	90	194	1189	793	594	475	396	339	297	264	237	216	198	183	169	158	148
60	T	784	1680	10290	6860	5145	4116	3430	2940	2573	2287	2058	1871	1715	1583	1470	1372	1286
	S	90	194	1189	793	594	475	396	339	297	264	237	216	198	183	169	158	148
80	T	784	1680	10290	6860	5145	4116	3430	2940	2573	2287	2058	1871	1715	1583	1470	1372	1286
	S	90	194	1189	793	594	475	396	339	297	264	237	216	198	183	169	158	148
100	T	784	1680	10290	6860	5145	4116	3430	2940	2573	2287	2058	1871	1715	1583	1470	1372	1286
	S	90	194	1189	793	594	475	396	339	297	264	237	216	198	183	169	158	148
120	T	784	1680	10290	6860	5145	4116	3430	2940	2573	2287	2058	1871	1715	1583	1470	1372	1286
	S	90	194	1189	793	594	475	396	339	297	264	237	216	198	183	169	158	148
140	T	784	1680	10290	6860	5145	4116	3430	2940	2573	2287	2058	1871	1715	1583	1470	1372	1286
	S	90	194	1189	793	594	475	396	339	297	264	237	216	198	183	169	158	148
160	T	784	1680	10290	6860	5145	4116	3430	2940	2573	2287	2058	1871	1715	1583	1470	1372	1286
	S	90	194	1189	793	594	475	396	339	297	264	237	216	198	183	169	158	148
180	T	784	1680	10290	6860	5145	4116	3430	2940	2573	2287	2058	1871	1715	1583	1470	1372	1286
	S	90	194	1189	793	594	475	396	339	297	264	237	216	198	183	169	158	148
200	T	784	1680	10290	6860	5145	4116	3430	2940	2573	2287	2058	1871	1715	1583	1470	1372	1286
	S	90	194	1189	793	594	475	396	339	297	264	237	216	198	183	169	158	148
220	T	784	1680	10290	6860	5145	4116	3430	2940	2573	2287	2058	1871	1715	1583	1470	1372	1286
	S	90	194	1189	793	594	475	396	339	297	264	237	216	198	183	169	158	148
240	T	784	1680	10290	6860	5145	4116	3430	2940	2573	2287	2058	1871	1715	1583	1470	1372	1286
	S	90	194	1189	793	594	475	396	339	297	264	237	216	198	183	169	158	148

Characteristic load-carrying capacity $F_{4/5,Rk}$ (N) for two angle brackets

b / e (mm)		0	20	40	60	80	100	120	140	160	180	200	220	240	260	280	300	320
0	T	63420	63420	63420	63420	63420	63420	63420	63420	63420	63420	63420	63420	63420	63420	63420	63420	63420
	S	-	-	-	-	-	-	-	-	-	-	-	-	-	-	-	-	-
20	T	63420	735	368	245	184	147	123	105	92	82	74	67	61	57	53	49	46
	S	-	339	169	113	84	67	56	48	42	37	33	30	28	26	24	22	21
40	T	63420	1470	735	490	368	294	245	210	184	163	147	134	123	113	105	98	92
	S	-	679	339	226	169	135	113	97	84	75	67	61	56	52	48	45	42
60	T	63420	2205	1103	735	551	441	368	315	276	245	221	200	184	170	158	147	138
	S	-	1019	509	339	254	203	169	145	127	113	101	92	84	78	72	67	63
80	T	63420	2940	1470	980	735	588	490	420	368	327	294	267	245	226	210	196	184
	S	-	1359	679	453	339	271	226	194	169	151	135	123	113	104	97	90	84
100	T	63420	3675	1838	1225	919	735	613	525	459	408	368	334	306	283	263	245	230
	S	-	1699	849	566	424	339	283	242	212	188	169	154	141	130	121	113	106
120	T	63420	4410	2205	1470	1103	882	735	630	551	490	441	401	368	339	315	294	276
	S	-	2039	1019	679	509	407	339	291	254	226	203	185	169	156	145	135	127
140	T	63420	5145	2573	1715	1286	1029	858	735	643	572	515	468	429	396	368	343	322
	S	-	2379	1189	793	594	475	396	339	297	264	237	216	198	183	169	158	148
160	T	63420	5880	2940	1960	1470	1176	980	840	735	653	588	535	490	452	420	392	368
	S	-	2719	1359	906	679	543	453	388	339	302	271	247	226	209	194	181	169
180	T	63420	6615	3308	2205	1654	1323	1103	945	827	735	662	601	551	509	473	441	413
	S	-	3059	1529	1019	764	611	509	437	382	339	305	278	254	235	218	203	191
200	T	63420	7350	3675	2450	1838	1470	1225	1050	919	817	735	668	613	565	525	490	459
	S	-	3399	1699	1133	849	679	566	485	424	377	339	309	283	261	242	226	212
220	T	63420	8085	4043	2695	2021	1617	1348	1155	1011	898	809	735	674	622	578	539	505
	S	-	3739	1869	1246	934	747	623	534	467	415	373	339	311	287	267	249	233
240	T	63420	8820	4410	2940	2205	1764	1470	1260	1103	980	882	802	735	678	630	588	551
	S	-	4078	2039	1359	1019	815	679	582	509	453	407	370	339	313	291	271	254

TTM: Timber-Timber-Maximum | TTP: Timber-Timber-Partial | TCM: Timber-Concrete-Maximum | TCP: Timber-Concrete-Partial

T: $F_{T,Rk}$ load-carrying capacity of timber | S: $F_{S,Rk}$ load-carrying capacity of steel

Table B. 126 Angle bracket type 9004S, Variant TTP, Fastener GH Nail 4x40, Density 350 kg/m³Characteristic load-carrying capacity $F_{T,Rk}$ (N) for one / two angle brackets

angle bracket		1												2	
f (mm)		0	10	20	30	40	50	60	70	80	90	100	110	120	0
$F_{T,Rk}$	T	224	149	112	89	74	64	56	50	45	41	38	35	32	448
	S	340	227	170	113	85	68	57	48	42	37	33	30	28	680

Characteristic load-carrying capacity $F_{2/3,Rk}$ (N) for one / two angle brackets

angle bracket		1	2
$F_{2/3,Rk}$	T	5410	10820
	S	-	-

Characteristic load-carrying capacity $F_{4,Rk}$ (N) for one angle bracket

e (mm)		0	20	40	60	80	100	120	140	160	180	200	220	240	260	280	300	320
$F_{4,Rk}$	T	11340	224	112	74	56	44	37	32	28	25	23	20	19	17	16	15	14
	S	-	340	170	113	80	54	41	33	27	23	20	18	16	15	14	12	12

Characteristic load-carrying capacity $F_{5,Rk}$ (N) for one angle bracket

b / e (mm)		0	20	40	60	80	100	120	140	160	180	200	220	240	260	280	300	320
0	T	240	514	785	524	393	314	262	224	196	174	157	143	131	121	112	104	98
	S	90	194	1190	793	595	476	397	340	297	264	238	216	198	183	170	159	149
20	T	240	514	1688	1125	844	675	563	482	422	375	338	307	281	260	241	225	211
	S	90	194	1189	793	594	475	396	339	297	264	237	216	198	183	169	158	148
40	T	240	514	2588	1725	1294	1035	863	739	647	575	518	470	431	398	370	345	323
	S	90	194	1189	793	594	475	396	339	297	264	237	216	198	183	169	158	148
60	T	240	514	3150	2100	1575	1260	1050	900	788	700	630	573	525	485	450	420	394
	S	90	194	1189	793	594	475	396	339	297	264	237	216	198	183	169	158	148
80	T	240	514	3150	2100	1575	1260	1050	900	788	700	630	573	525	485	450	420	394
	S	90	194	1189	793	594	475	396	339	297	264	237	216	198	183	169	158	148
100	T	240	514	3150	2100	1575	1260	1050	900	788	700	630	573	525	485	450	420	394
	S	90	194	1189	793	594	475	396	339	297	264	237	216	198	183	169	158	148
120	T	240	514	3150	2100	1575	1260	1050	900	788	700	630	573	525	485	450	420	394
	S	90	194	1189	793	594	475	396	339	297	264	237	216	198	183	169	158	148
140	T	240	514	3150	2100	1575	1260	1050	900	788	700	630	573	525	485	450	420	394
	S	90	194	1189	793	594	475	396	339	297	264	237	216	198	183	169	158	148
160	T	240	514	3150	2100	1575	1260	1050	900	788	700	630	573	525	485	450	420	394
	S	90	194	1189	793	594	475	396	339	297	264	237	216	198	183	169	158	148
180	T	240	514	3150	2100	1575	1260	1050	900	788	700	630	573	525	485	450	420	394
	S	90	194	1189	793	594	475	396	339	297	264	237	216	198	183	169	158	148
200	T	240	514	3150	2100	1575	1260	1050	900	788	700	630	573	525	485	450	420	394
	S	90	194	1189	793	594	475	396	339	297	264	237	216	198	183	169	158	148
220	T	240	514	3150	2100	1575	1260	1050	900	788	700	630	573	525	485	450	420	394
	S	90	194	1189	793	594	475	396	339	297	264	237	216	198	183	169	158	148
240	T	240	514	3150	2100	1575	1260	1050	900	788	700	630	573	525	485	450	420	394
	S	90	194	1189	793	594	475	396	339	297	264	237	216	198	183	169	158	148

Characteristic load-carrying capacity $F_{4/5,Rk}$ (N) for two angle brackets

b / e (mm)		0	20	40	60	80	100	120	140	160	180	200	220	240	260	280	300	320
0	T	14400	14400	14400	14400	14400	14400	14400	14400	14400	14400	14400	14400	14400	14400	14400	14400	14400
	S	-	-	-	-	-	-	-	-	-	-	-	-	-	-	-	-	-
20	T	14400	224	112	74	56	44	37	32	28	24	22	20	18	17	16	14	14
	S	-	340	170	113	85	68	57	49	42	38	34	31	28	26	24	23	21
40	T	14400	449	224	149	112	89	74	64	56	49	44	40	37	34	32	29	28
	S	-	680	340	227	170	136	113	97	85	76	68	62	57	52	49	45	42
60	T	14400	674	337	224	168	134	112	96	84	74	67	61	56	51	48	44	42
	S	-	1020	510	340	255	204	170	146	127	113	102	93	85	78	73	68	64
80	T	14400	899	449	299	224	179	149	128	112	99	89	81	74	69	64	59	56
	S	-	1360	680	453	340	272	227	194	170	151	136	124	113	105	97	91	85
100	T	14400	1123	562	374	281	224	187	160	140	124	112	102	93	86	80	74	70
	S	-	1700	850	567	425	340	283	243	212	189	170	155	142	131	121	113	106
120	T	14400	1347	674	449	337	269	224	192	168	149	134	122	112	103	96	89	84
	S	-	2039	1020	680	510	408	340	291	255	227	204	185	170	157	146	136	127
140	T	14400	1571	787	524	393	314	262	224	196	174	157	143	131	121	112	104	98
	S	-	2379	1190	793	595	476	397	340	297	264	238	216	198	183	170	159	149
160	T	14400	1794	899	599	449	359	299	257	224	199	179	163	149	138	128	119	112
	S	-	2719	1360	906	680	544	453	388	340	302	272	247	227	209	194	181	170
180	T	14400	2016	1011	674	506	404	337	289	253	224	202	184	168	155	144	134	126
	S	-	3059	1530	1020	765	612	510	437	382	340	306	278	255	235	219	204	191
200	T	14400	2239	1123	749	562	449	374	321	281	249	224	204	187	173	160	149	140
	S	-	3399	1700	1133	850	680	567	486	425	378	340	309	283	261	243	227	212
220	T	14400	2460	1235	824	618	494	412	353	309	274	247	224	206	190	176	164	154
	S	-	3739	1870	1246	935	748	623	534	467	415	374	340	312	288	267	249	234
240	T	14400	2681	1347	899	674	539	449	385	337	299	269	245	224	207	192	179	168
	S	-	4079	2039	1360	1020	816	680	583	510	453	408	371	340	314	291	272	255

TTM: Timber-Timber-Maximum | TTP: Timber-Timber-Partial | TCM: Timber-Concrete-Maximum | TCP: Timber-Concrete-Partial

T: $F_{T,Rk}$ load-carrying capacity of timber | S: $F_{S,Rk}$ load-carrying capacity of steel

Table B. 127 Angle bracket type 9004S, Variant TTP, Fastener GH Nail 4x60, Density 350 kg/m³Characteristic load-carrying capacity $F_{T,Rk}$ (N) for one / two angle brackets

angle bracket		1													2
f (mm)		0	10	20	30	40	50	60	70	80	90	100	110	120	0
$F_{T,Rk}$	T	375	250	188	150	125	107	94	83	75	68	63	58	54	750
	S	339	226	169	113	84	67	56	48	42	37	33	30	28	678

Characteristic load-carrying capacity $F_{2/3,Rk}$ (N) for one / two angle brackets

angle bracket		1	2
$F_{2/3,Rk}$	T	6760	13520
	S	-	-

Characteristic load-carrying capacity $F_{4,Rk}$ (N) for one angle bracket

e (mm)		0	20	40	60	80	100	120	140	160	180	200	220	240	260	280	300	320
$F_{4,Rk}$	T	14184	375	188	125	94	75	63	54	47	42	38	34	31	29	27	25	23
	S	-	339	169	113	79	54	41	33	27	23	20	18	16	15	14	12	12

Characteristic load-carrying capacity $F_{5,Rk}$ (N) for one angle bracket

b / e (mm)		0	20	40	60	80	100	120	140	160	180	200	220	240	260	280	300	320
0	T	400	857	1313	875	656	525	438	375	328	292	263	239	219	202	188	175	164
	S	90	194	1189	793	594	475	396	339	297	264	237	216	198	183	169	158	148
20	T	400	857	2813	1875	1406	1125	938	804	703	625	563	511	469	433	402	375	352
	S	90	194	1189	793	594	475	396	339	297	264	237	216	198	183	169	158	148
40	T	400	857	4313	2875	2156	1725	1438	1232	1078	958	863	784	719	663	616	575	539
	S	90	194	1189	793	594	475	396	339	297	264	237	216	198	183	169	158	148
60	T	400	857	5250	3500	2625	2100	1750	1500	1313	1167	1050	955	875	808	750	700	656
	S	90	194	1189	793	594	475	396	339	297	264	237	216	198	183	169	158	148
80	T	400	857	5250	3500	2625	2100	1750	1500	1313	1167	1050	955	875	808	750	700	656
	S	90	194	1189	793	594	475	396	339	297	264	237	216	198	183	169	158	148
100	T	400	857	5250	3500	2625	2100	1750	1500	1313	1167	1050	955	875	808	750	700	656
	S	90	194	1189	793	594	475	396	339	297	264	237	216	198	183	169	158	148
120	T	400	857	5250	3500	2625	2100	1750	1500	1313	1167	1050	955	875	808	750	700	656
	S	90	194	1189	793	594	475	396	339	297	264	237	216	198	183	169	158	148
140	T	400	857	5250	3500	2625	2100	1750	1500	1313	1167	1050	955	875	808	750	700	656
	S	90	194	1189	793	594	475	396	339	297	264	237	216	198	183	169	158	148
160	T	400	857	5250	3500	2625	2100	1750	1500	1313	1167	1050	955	875	808	750	700	656
	S	90	194	1189	793	594	475	396	339	297	264	237	216	198	183	169	158	148
180	T	400	857	5250	3500	2625	2100	1750	1500	1313	1167	1050	955	875	808	750	700	656
	S	90	194	1189	793	594	475	396	339	297	264	237	216	198	183	169	158	148
200	T	400	857	5250	3500	2625	2100	1750	1500	1313	1167	1050	955	875	808	750	700	656
	S	90	194	1189	793	594	475	396	339	297	264	237	216	198	183	169	158	148
220	T	400	857	5250	3500	2625	2100	1750	1500	1313	1167	1050	955	875	808	750	700	656
	S	90	194	1189	793	594	475	396	339	297	264	237	216	198	183	169	158	148
240	T	400	857	5250	3500	2625	2100	1750	1500	1313	1167	1050	955	875	808	750	700	656
	S	90	194	1189	793	594	475	396	339	297	264	237	216	198	183	169	158	148

Characteristic load-carrying capacity $F_{4/5,Rk}$ (N) for two angle brackets

b / e (mm)		0	20	40	60	80	100	120	140	160	180	200	220	240	260	280	300	320
0	T	23999	23999	23999	23999	23999	23999	23999	23999	23999	23999	23999	23999	23999	23999	23999	23999	23999
	S	-	-	-	-	-	-	-	-	-	-	-	-	-	-	-	-	-
20	T	23999	375	188	125	94	75	63	54	47	42	38	34	31	29	27	25	23
	S	-	339	169	113	84	67	56	48	42	37	33	30	28	26	24	22	21
40	T	23999	750	375	250	188	150	125	107	94	83	75	68	63	58	54	50	47
	S	-	679	339	226	169	135	113	97	84	75	67	61	56	52	48	45	42
60	T	23999	1125	563	375	281	225	188	161	141	125	113	102	94	87	80	75	70
	S	-	1019	509	339	254	203	169	145	127	113	101	92	84	78	72	67	63
80	T	23999	1500	750	500	375	300	250	214	188	167	150	136	125	115	107	100	94
	S	-	1359	679	453	339	271	226	194	169	151	135	123	113	104	97	90	84
100	T	23999	1875	938	625	469	375	313	268	234	208	188	170	156	144	134	125	117
	S	-	1699	849	566	424	339	283	242	212	188	169	154	141	130	121	113	106
120	T	23999	2250	1125	750	563	450	375	321	281	250	225	205	188	173	161	150	141
	S	-	2039	1019	679	509	407	339	291	254	226	203	185	169	156	145	135	127
140	T	23999	2625	1313	875	656	525	438	375	328	292	263	239	219	202	188	175	164
	S	-	2379	1189	793	594	475	396	339	297	264	237	216	198	183	169	158	148
160	T	23999	3000	1500	1000	750	600	500	429	375	333	300	273	250	231	214	200	188
	S	-	2719	1359	906	679	543	453	388	339	302	271	247	226	209	194	181	169
180	T	23999	3375	1688	1125	844	675	563	482	422	375	338	307	281	260	241	225	211
	S	-	3059	1529	1019	764	611	509	437	382	339	305	278	254	235	218	203	191
200	T	23999	3750	1875	1250	938	750	625	536	469	417	375	341	313	288	268	250	234
	S	-	3399	1699	1133	849	679	566	485	424	377	339	309	283	261	242	226	212
220	T	23999	4125	2063	1375	1031	825	688	589	516	458	413	375	344	317	295	275	258
	S	-	3739	1869	1246	934	747	623	534	467	415	373	339	311	287	267	249	233
240	T	23999	4500	2250	1500	1125	900	750	643	563	500	450	409	375	346	321	300	281
	S	-	4078	2039	1359	1019	815	679	582	509	453	407	370	339	313	291	271	254

TTM: Timber-Timber-Maximum | TTP: Timber-Timber-Partial | TCM: Timber-Concrete-Maximum | TCP: Timber-Concrete-Partial

T: $F_{T,Rk}$ load-carrying capacity of timber | S: $F_{S,Rk}$ load-carrying capacity of steel

Table B. 128 Angle bracket type 9004S, Variant TTP, Fastener GH Screw 5x40, Density 350 kg/m³Characteristic load-carrying capacity $F_{1,Rk}$ (N) for one / two angle brackets

angle bracket		1													2
f (mm)		0	10	20	30	40	50	60	70	80	90	100	110	120	0
$F_{1,Rk}$	T	473	315	236	189	158	135	118	105	95	86	79	73	68	945
	S	339	226	169	113	84	67	56	48	42	37	33	30	28	678

Characteristic load-carrying capacity $F_{2/3,Rk}$ (N) for one / two angle brackets

angle bracket		1	2
$F_{2/3,Rk}$	T	5730	11460
	S	-	-

Characteristic load-carrying capacity $F_{4,Rk}$ (N) for one angle bracket

e (mm)		0	20	40	60	80	100	120	140	160	180	200	220	240	260	280	300	320
$F_{4,Rk}$	T	12018	473	236	158	118	95	79	68	59	53	47	43	39	36	34	32	30
	S	-	339	169	113	79	54	41	33	27	23	20	18	16	15	14	12	12

Characteristic load-carrying capacity $F_{5,Rk}$ (N) for one angle bracket

b / e (mm)		0	20	40	60	80	100	120	140	160	180	200	220	240	260	280	300	320
0	T	504	1080	1654	1103	827	662	551	473	413	368	331	301	276	254	236	221	207
	S	90	194	1189	793	594	475	396	339	297	264	237	216	198	183	169	158	148
20	T	504	1080	3544	2363	1772	1418	1181	1013	886	788	709	644	591	545	506	473	443
	S	90	194	1189	793	594	475	396	339	297	264	237	216	198	183	169	158	148
40	T	504	1080	5434	3623	2717	2174	1811	1553	1358	1208	1087	988	906	836	776	725	679
	S	90	194	1189	793	594	475	396	339	297	264	237	216	198	183	169	158	148
60	T	504	1080	6615	4410	3308	2646	2205	1890	1654	1470	1323	1203	1103	1018	945	882	827
	S	90	194	1189	793	594	475	396	339	297	264	237	216	198	183	169	158	148
80	T	504	1080	6615	4410	3308	2646	2205	1890	1654	1470	1323	1203	1103	1018	945	882	827
	S	90	194	1189	793	594	475	396	339	297	264	237	216	198	183	169	158	148
100	T	504	1080	6615	4410	3308	2646	2205	1890	1654	1470	1323	1203	1103	1018	945	882	827
	S	90	194	1189	793	594	475	396	339	297	264	237	216	198	183	169	158	148
120	T	504	1080	6615	4410	3308	2646	2205	1890	1654	1470	1323	1203	1103	1018	945	882	827
	S	90	194	1189	793	594	475	396	339	297	264	237	216	198	183	169	158	148
140	T	504	1080	6615	4410	3308	2646	2205	1890	1654	1470	1323	1203	1103	1018	945	882	827
	S	90	194	1189	793	594	475	396	339	297	264	237	216	198	183	169	158	148
160	T	504	1080	6615	4410	3308	2646	2205	1890	1654	1470	1323	1203	1103	1018	945	882	827
	S	90	194	1189	793	594	475	396	339	297	264	237	216	198	183	169	158	148
180	T	504	1080	6615	4410	3308	2646	2205	1890	1654	1470	1323	1203	1103	1018	945	882	827
	S	90	194	1189	793	594	475	396	339	297	264	237	216	198	183	169	158	148
200	T	504	1080	6615	4410	3308	2646	2205	1890	1654	1470	1323	1203	1103	1018	945	882	827
	S	90	194	1189	793	594	475	396	339	297	264	237	216	198	183	169	158	148
220	T	504	1080	6615	4410	3308	2646	2205	1890	1654	1470	1323	1203	1103	1018	945	882	827
	S	90	194	1189	793	594	475	396	339	297	264	237	216	198	183	169	158	148
240	T	504	1080	6615	4410	3308	2646	2205	1890	1654	1470	1323	1203	1103	1018	945	882	827
	S	90	194	1189	793	594	475	396	339	297	264	237	216	198	183	169	158	148

Characteristic load-carrying capacity $F_{4/5,Rk}$ (N) for two angle brackets

b / e (mm)		0	20	40	60	80	100	120	140	160	180	200	220	240	260	280	300	320
0	T	24035	24035	24035	24035	24035	24035	24035	24035	24035	24035	24035	24035	24035	24035	24035	24035	24035
	S	-	-	-	-	-	-	-	-	-	-	-	-	-	-	-	-	-
20	T	24035	473	236	158	118	95	79	68	59	53	47	43	39	36	34	32	30
	S	-	339	169	113	84	67	56	48	42	37	33	30	28	26	24	22	21
40	T	24035	945	473	315	236	189	158	135	118	105	95	86	79	73	68	63	59
	S	-	679	339	226	169	135	113	97	84	75	67	61	56	52	48	45	42
60	T	24035	1418	709	473	354	284	236	203	177	158	142	129	118	109	101	95	89
	S	-	1019	509	339	254	203	169	145	127	113	101	92	84	78	72	67	63
80	T	24035	1890	945	630	473	378	315	270	236	210	189	172	158	145	135	126	118
	S	-	1359	679	453	339	271	226	194	169	151	135	123	113	104	97	90	84
100	T	24035	2363	1181	788	591	473	394	338	295	263	236	215	197	182	169	158	148
	S	-	1699	849	566	424	339	283	242	212	188	169	154	141	130	121	113	106
120	T	24035	2835	1418	945	709	567	473	405	354	315	284	258	236	218	203	189	177
	S	-	2039	1019	679	509	407	339	291	254	226	203	185	169	156	145	135	127
140	T	24035	3308	1654	1103	827	662	551	473	413	368	331	301	276	254	236	221	207
	S	-	2379	1189	793	594	475	396	339	297	264	237	216	198	183	169	158	148
160	T	24035	3780	1890	1260	945	756	630	540	473	420	378	344	315	291	270	252	236
	S	-	2719	1359	906	679	543	453	388	339	302	271	247	226	209	194	181	169
180	T	24035	4253	2126	1418	1063	851	709	608	532	473	425	387	354	327	304	284	266
	S	-	3059	1529	1019	764	611	509	437	382	339	305	278	254	235	218	203	191
200	T	24035	4725	2363	1575	1181	945	788	675	591	525	473	430	394	363	338	315	295
	S	-	3399	1699	1133	849	679	566	485	424	377	339	309	283	261	242	226	212
220	T	24035	5198	2599	1733	1299	1040	866	743	650	578	520	473	433	400	371	347	325
	S	-	3739	1869	1246	934	747	623	534	467	415	373	339	311	287	267	249	233
240	T	24035	5670	2835	1890	1418	1134	945	810	709	630	567	515	473	436	405	378	354
	S	-	4078	2039	1359	1019	815	679	582	509	453	407	370	339	313	291	271	254

TTM: Timber-Timber-Maximum | TTP: Timber-Timber-Partial | TCM: Timber-Concrete-Maximum | TCP: Timber-Concrete-Partial

T: $F_{1,T,Rk}$ load-carrying capacity of timber | S: $F_{1,S,Rk}$ load-carrying capacity of steel

Table B. 129 Angle bracket type 9004S, Variant TTP, Fastener GH Screw 5x60, Density 350 kg/m³Characteristic load-carrying capacity $F_{T,Rk}$ (N) for one / two angle brackets

angle bracket		1													2
f (mm)		0	10	20	30	40	50	60	70	80	90	100	110	120	0
$F_{T,Rk}$	T	735	490	368	294	245	210	184	163	147	134	123	113	105	1470
	S	339	226	169	113	84	67	56	48	42	37	33	30	28	678

Characteristic load-carrying capacity $F_{2/3,Rk}$ (N) for one / two angle brackets

angle bracket		1	2
$F_{2/3,Rk}$	T	6480	12960
	S	-	-

Characteristic load-carrying capacity $F_{4,Rk}$ (N) for one angle bracket

e (mm)		0	20	40	60	80	100	120	140	160	180	200	220	240	260	280	300	320
$F_{4,Rk}$	T	13590	735	368	245	184	147	123	105	92	82	74	67	61	57	53	49	46
	S	-	339	169	113	79	54	41	33	27	23	20	18	16	15	14	12	12

Characteristic load-carrying capacity $F_{5,Rk}$ (N) for one angle bracket

b / e (mm)		0	20	40	60	80	100	120	140	160	180	200	220	240	260	280	300	320
0	T	784	1680	2573	1715	1286	1029	858	735	643	572	515	468	429	396	368	343	322
	S	90	194	1189	793	594	475	396	339	297	264	237	216	198	183	169	158	148
20	T	784	1680	5513	3675	2756	2205	1838	1575	1378	1225	1103	1002	919	848	788	735	689
	S	90	194	1189	793	594	475	396	339	297	264	237	216	198	183	169	158	148
40	T	784	1680	8453	5635	4226	3381	2818	2415	2113	1878	1691	1537	1409	1300	1208	1127	1057
	S	90	194	1189	793	594	475	396	339	297	264	237	216	198	183	169	158	148
60	T	784	1680	10290	6860	5145	4116	3430	2940	2573	2287	2058	1871	1715	1583	1470	1372	1286
	S	90	194	1189	793	594	475	396	339	297	264	237	216	198	183	169	158	148
80	T	784	1680	10290	6860	5145	4116	3430	2940	2573	2287	2058	1871	1715	1583	1470	1372	1286
	S	90	194	1189	793	594	475	396	339	297	264	237	216	198	183	169	158	148
100	T	784	1680	10290	6860	5145	4116	3430	2940	2573	2287	2058	1871	1715	1583	1470	1372	1286
	S	90	194	1189	793	594	475	396	339	297	264	237	216	198	183	169	158	148
120	T	784	1680	10290	6860	5145	4116	3430	2940	2573	2287	2058	1871	1715	1583	1470	1372	1286
	S	90	194	1189	793	594	475	396	339	297	264	237	216	198	183	169	158	148
140	T	784	1680	10290	6860	5145	4116	3430	2940	2573	2287	2058	1871	1715	1583	1470	1372	1286
	S	90	194	1189	793	594	475	396	339	297	264	237	216	198	183	169	158	148
160	T	784	1680	10290	6860	5145	4116	3430	2940	2573	2287	2058	1871	1715	1583	1470	1372	1286
	S	90	194	1189	793	594	475	396	339	297	264	237	216	198	183	169	158	148
180	T	784	1680	10290	6860	5145	4116	3430	2940	2573	2287	2058	1871	1715	1583	1470	1372	1286
	S	90	194	1189	793	594	475	396	339	297	264	237	216	198	183	169	158	148
200	T	784	1680	10290	6860	5145	4116	3430	2940	2573	2287	2058	1871	1715	1583	1470	1372	1286
	S	90	194	1189	793	594	475	396	339	297	264	237	216	198	183	169	158	148
220	T	784	1680	10290	6860	5145	4116	3430	2940	2573	2287	2058	1871	1715	1583	1470	1372	1286
	S	90	194	1189	793	594	475	396	339	297	264	237	216	198	183	169	158	148
240	T	784	1680	10290	6860	5145	4116	3430	2940	2573	2287	2058	1871	1715	1583	1470	1372	1286
	S	90	194	1189	793	594	475	396	339	297	264	237	216	198	183	169	158	148

Characteristic load-carrying capacity $F_{4/5,Rk}$ (N) for two angle brackets

b / e (mm)		0	20	40	60	80	100	120	140	160	180	200	220	240	260	280	300	320
0	T	27179	27179	27179	27179	27179	27179	27179	27179	27179	27179	27179	27179	27179	27179	27179	27179	27179
	S	-	-	-	-	-	-	-	-	-	-	-	-	-	-	-	-	-
20	T	27179	735	368	245	184	147	123	105	92	82	74	67	61	57	53	49	46
	S	-	339	169	113	84	67	56	48	42	37	33	30	28	26	24	22	21
40	T	27179	1470	735	490	368	294	245	210	184	163	147	134	123	113	105	98	92
	S	-	679	339	226	169	135	113	97	84	75	67	61	56	52	48	45	42
60	T	27179	2205	1103	735	551	441	368	315	276	245	221	200	184	170	158	147	138
	S	-	1019	509	339	254	203	169	145	127	113	101	92	84	78	72	67	63
80	T	27179	2940	1470	980	735	588	490	420	368	327	294	267	245	226	210	196	184
	S	-	1359	679	453	339	271	226	194	169	151	135	123	113	104	97	90	84
100	T	27179	3675	1838	1225	919	735	613	525	459	408	368	334	306	283	263	245	230
	S	-	1699	849	566	424	339	283	242	212	188	169	154	141	130	121	113	106
120	T	27179	4410	2205	1470	1103	882	735	630	551	490	441	401	368	339	315	294	276
	S	-	2039	1019	679	509	407	339	291	254	226	203	185	169	156	145	135	127
140	T	27179	5145	2573	1715	1286	1029	858	735	643	572	515	468	429	396	368	343	322
	S	-	2379	1189	793	594	475	396	339	297	264	237	216	198	183	169	158	148
160	T	27179	5880	2940	1960	1470	1176	980	840	735	653	588	535	490	452	420	392	368
	S	-	2719	1359	906	679	543	453	388	339	302	271	247	226	209	194	181	169
180	T	27179	6615	3308	2205	1654	1323	1103	945	827	735	662	601	551	509	473	441	413
	S	-	3059	1529	1019	764	611	509	437	382	339	305	278	254	235	218	203	191
200	T	27179	7350	3675	2450	1838	1470	1225	1050	919	817	735	668	613	565	525	490	459
	S	-	3399	1699	1133	849	679	566	485	424	377	339	309	283	261	242	226	212
220	T	27179	8085	4043	2695	2021	1617	1348	1155	1011	898	809	735	674	622	578	539	505
	S	-	3739	1869	1246	934	747	623	534	467	415	373	339	311	287	267	249	233
240	T	27179	8820	4410	2940	2205	1764	1470	1260	1103	980	882	802	735	678	630	588	551
	S	-	4078	2039	1359	1019	815	679	582	509	453	407	370	339	313	291	271	254

TTM: Timber-Timber-Maximum | TTP: Timber-Timber-Partial | TCM: Timber-Concrete-Maximum | TCP: Timber-Concrete-Partial

T: $F_{T,Rk}$ load-carrying capacity of timber | S: $F_{S,Rk}$ load-carrying capacity of steel

Table B. 130 Angle bracket type 5501SA4, Variant TCM, Fastener Profiled nail A4 4x40, Density 350 kg/m³

Characteristic load-carrying capacity $F_{1,Rk}$ (N) for one / two angle brackets															
angle bracket	1													2	
f (mm)	0	10	20	30	40	50	60	70	80	90	100	110	120	0	
$F_{1,Rk}$	T	8200	810	405	270	203	162	135	116	101	89	80	73	67	16400
	S	250	210	181	160	142	128	117	107	99	93	87	81	77	500
k_t (-)	9,6	11,5	13,3	15,1	16,9	18,7	20,5	22,4	24,2	26,0	27,8	29,6	31,5	4,8	

Characteristic load-carrying capacity $F_{2/3,Rk}$ (N) for one / two angle brackets			
angle bracket	1	2	
$F_{2/3,Rk}$	T	1250	2500
	S	-	-

Characteristic load-carrying capacity $F_{4,Rk}$ (N) for one angle bracket																	
e (mm)	0	20	40	60	80	100	120	140	160	180	200	220	240	260	280	300	320
$F_{4,Rk}$	T	-	-	4050	368	193	130	98	79	66	57	49	44	40	36	33	28
	S	-	664	332	221	166	133	111	95	83	74	66	60	55	51	47	42
k_t (-)	0,0	3,6	7,3	10,9	14,5	18,2	21,8	25,5	29,1	32,7	36,4	40,0	43,6	47,3	50,9	54,5	58,2

Characteristic load-carrying capacity $F_{5,Rk}$ (N) for one angle bracket																		
b / e (mm)	0	20	40	60	80	100	120	140	160	180	200	220	240	260	280	300	320	
0	T	213	449	1507	1004	753	602	502	430	376	334	301	274	251	231	215	200	188
	S	405	856	2868	1912	1434	1147	956	819	717	637	574	521	478	441	410	382	358
20	T	213	449	1414	943	707	565	471	404	353	314	282	257	235	217	202	188	176
	S	405	856	2868	1912	1434	1147	956	819	717	637	574	521	478	441	410	382	358
40	T	213	449	1482	988	741	593	494	423	370	329	296	269	247	228	211	197	185
	S	405	856	2868	1912	1434	1147	956	819	717	637	574	521	478	441	410	382	358
60	T	213	449	1496	997	748	598	498	427	374	332	299	272	249	230	213	199	187
	S	405	856	2868	1912	1434	1147	956	819	717	637	574	521	478	441	410	382	358
80	T	213	449	1501	1000	750	600	500	428	375	333	300	272	250	230	214	200	187
	S	405	856	2868	1912	1434	1147	956	819	717	637	574	521	478	441	410	382	358
100	T	213	449	1503	1002	751	601	501	429	375	334	300	273	250	231	214	200	187
	S	405	856	2868	1912	1434	1147	956	819	717	637	574	521	478	441	410	382	358
120	T	213	449	1504	1003	752	601	501	429	376	334	300	273	250	231	214	200	188
	S	405	856	2868	1912	1434	1147	956	819	717	637	574	521	478	441	410	382	358
140	T	213	449	1505	1003	752	602	501	430	376	334	301	273	250	231	215	200	188
	S	405	856	2868	1912	1434	1147	956	819	717	637	574	521	478	441	410	382	358
160	T	213	449	1505	1003	752	602	501	430	376	334	301	273	250	231	215	200	188
	S	405	856	2868	1912	1434	1147	956	819	717	637	574	521	478	441	410	382	358
180	T	213	449	1506	1004	753	602	502	430	376	334	301	273	251	231	215	200	188
	S	405	856	2868	1912	1434	1147	956	819	717	637	574	521	478	441	410	382	358
200	T	213	449	1506	1004	753	602	502	430	376	334	301	273	251	231	215	200	188
	S	405	856	2868	1912	1434	1147	956	819	717	637	574	521	478	441	410	382	358
220	T	213	449	1506	1004	753	602	502	430	376	334	301	273	251	231	215	200	188
	S	405	856	2868	1912	1434	1147	956	819	717	637	574	521	478	441	410	382	358
240	T	213	449	1506	1004	753	602	502	430	376	334	301	273	251	231	215	200	188
	S	405	856	2868	1912	1434	1147	956	819	717	637	574	521	478	441	410	382	358
$k_t \times b$ (-)	0,0	16,7	33,4	50,1	66,8	83,5	100,2	116,9	133,6	150,3	167,0	183,7	200,3	217,0	233,7	250,4	267,1	

Characteristic load-carrying capacity $F_{4/5,Rk}$ (N) for two angle brackets																		
b / e (mm)	0	20	40	60	80	100	120	140	160	180	200	220	240	260	280	300	320	
0	T	8999	8999	8999	8999	8999	8999	8999	8999	8999	8999	8999	8999	8999	8999	8999	8999	
	S	-	-	-	-	-	-	-	-	-	-	-	-	-	-	-	-	
20	T	8999	8200	4100	2733	2050	1640	1367	1171	1025	911	820	745	683	631	586	547	513
	S	-	250	125	83	62	50	41	35	31	27	25	22	20	19	17	16	15
40	T	8999	9000	8200	5467	4100	3280	2733	2343	2050	1822	1640	1491	1367	1262	1171	1093	1025
	S	-	501	250	167	125	100	83	71	62	55	50	45	41	38	35	33	31
60	T	8999	9000	9000	8200	6150	4920	4100	3514	3075	2733	2460	2236	2050	1892	1757	1640	1538
	S	-	751	375	250	187	150	125	107	93	83	75	68	62	57	53	50	46
80	T	8999	9000	9000	9000	8200	6560	5467	4686	4100	3644	3280	2982	2733	2523	2343	2187	2050
	S	-	1002	501	334	250	200	167	143	125	111	100	91	83	77	71	66	62
100	T	8999	9000	9000	9000	9000	8200	6833	5857	5125	4556	4100	3727	3417	3154	2929	2733	2563
	S	-	1253	626	417	313	250	208	179	156	139	125	113	104	96	89	83	78
120	T	8999	9000	9000	9000	9000	8200	7029	6150	5467	4920	4473	4100	3785	3514	3280	3075	3075
	S	-	1503	751	501	375	300	250	214	187	167	150	136	125	115	107	100	93
140	T	8999	9000	9000	9000	9000	9000	8200	7175	6378	5740	5218	4783	4415	4100	3827	3588	3588
	S	-	1754	877	584	438	350	292	250	219	194	175	159	146	134	125	116	109
160	T	8999	9000	9000	9000	9000	9000	9000	8200	7289	6560	5964	5467	5046	4686	4373	4100	4100
	S	-	2004	1002	668	501	400	334	286	250	222	200	182	167	154	143	133	125
180	T	8999	9000	9000	9000	9000	9000	9000	9000	8200	7380	6709	6150	5677	5271	4920	4613	4613
	S	-	2255	1127	751	563	451	375	322	281	250	225	205	187	173	161	150	140
200	T	8999	9000	9000	9000	9000	9000	9000	9000	9000	8200	7455	6833	6308	5857	5467	5125	5125
	S	-	2506	1253	835	626	501	417	358	313	278	250	227	208	192	179	167	156
220	T	8999	9000	9000	9000	9000	9000	9000	9000	9000	9000	8200	7517	6938	6443	6013	5638	5638
	S	-	2756	1378	918	689	551	459	393	344	306	275	250	229	212	196	183	172
240	T	8999	9000	9000	9000	9000	9000	9000	9000	9000	9000	8945	8200	7569	7029	6560	6150	6150
	S	-	3007	1503	1002	751	601	501	429	375	334	300	273	250	231	214	200	187
$k_t \times b$ (-)	0,0	192,7	385,5	578,2	770,9	963,6	1156,4	1349,1	1541,8	1734,5	1927,3	2120,0	2312,7	2505,5	2698,2	2890,9	3083,6	

TTM: Timber-Timber-Maximum | TTP: Timber-Timber-Partial | TCM: Timber-Concrete-Maximum | TCP: Timber-Concrete-Partial

T: $F_{1,T,Rk}$ load-carrying capacity of timber | S: $F_{1,S,Rk}$ load-carrying capacity of steel

Table B. 131 Angle bracket type 5501SA4, Variant TCM, Fastener Profiled nail A4 4x60, Density 350 kg/m³Characteristic load-carrying capacity $F_{1,Rk}$ (N) for one / two angle brackets

angle bracket		1													2
f (mm)		0	10	20	30	40	50	60	70	80	90	100	110	120	0
$F_{1,Rk}$	T	9945	1350	675	450	338	270	225	193	169	150	135	123	113	19890
	S	250	210	181	160	142	128	117	107	99	92	86	81	76	500
k_t (-)		9,6	11,5	13,3	15,1	16,9	18,7	20,5	22,4	24,2	26,0	27,8	29,6	31,5	4,8

Characteristic load-carrying capacity $F_{2/3,Rk}$ (N) for one / two angle brackets

angle bracket		1	2
$F_{2/3,Rk}$	T	1880	3760
	S	-	-

Characteristic load-carrying capacity $F_{4,Rk}$ (N) for one angle bracket

e (mm)		0	20	40	60	80	100	120	140	160	180	200	220	240	260	280	300	320
$F_{4,Rk}$	T	-	-	6750	614	321	218	165	132	111	95	83	74	67	61	56	52	48
	S	-	664	332	221	166	132	110	94	83	73	66	60	55	51	47	44	41
k_t (-)		0,0	3,6	7,3	10,9	14,5	18,2	21,8	25,5	29,1	32,7	36,4	40,0	43,6	47,3	50,9	54,5	58,2

Characteristic load-carrying capacity $F_{5,Rk}$ (N) for one angle bracket

b / e (mm)		0	20	40	60	80	100	120	140	160	180	200	220	240	260	280	300	320
0	T	355	749	2512	1675	1256	1005	837	717	628	558	502	456	418	386	358	334	314
	S	405	856	2868	1912	1434	1147	956	819	717	637	574	521	478	441	410	382	358
20	T	355	749	2242	1494	1121	896	747	640	560	498	448	407	373	344	320	298	280
	S	405	856	2868	1912	1434	1147	956	819	717	637	574	521	478	441	410	382	358
40	T	355	749	2435	1623	1217	974	811	695	608	541	487	442	405	374	347	324	304
	S	405	856	2868	1912	1434	1147	956	819	717	637	574	521	478	441	410	382	358
60	T	355	749	2477	1651	1238	991	825	707	619	550	495	450	412	381	353	330	309
	S	405	856	2868	1912	1434	1147	956	819	717	637	574	521	478	441	410	382	358
80	T	355	749	2492	1661	1246	997	830	712	623	553	498	453	415	383	356	332	311
	S	405	856	2868	1912	1434	1147	956	819	717	637	574	521	478	441	410	382	358
100	T	355	749	2499	1666	1249	999	833	714	624	555	499	454	416	384	357	333	312
	S	405	856	2868	1912	1434	1147	956	819	717	637	574	521	478	441	410	382	358
120	T	355	749	2503	1669	1251	1001	834	715	625	556	500	455	417	385	357	333	312
	S	405	856	2868	1912	1434	1147	956	819	717	637	574	521	478	441	410	382	358
140	T	355	749	2505	1670	1252	1002	835	715	626	556	501	455	417	385	357	334	313
	S	405	856	2868	1912	1434	1147	956	819	717	637	574	521	478	441	410	382	358
160	T	355	749	2507	1671	1253	1003	835	716	626	557	501	455	417	385	358	334	313
	S	405	856	2868	1912	1434	1147	956	819	717	637	574	521	478	441	410	382	358
180	T	355	749	2508	1672	1254	1003	836	716	627	557	501	456	418	385	358	334	313
	S	405	856	2868	1912	1434	1147	956	819	717	637	574	521	478	441	410	382	358
200	T	355	749	2509	1672	1254	1003	836	716	627	557	501	456	418	386	358	334	313
	S	405	856	2868	1912	1434	1147	956	819	717	637	574	521	478	441	410	382	358
220	T	355	749	2509	1673	1254	1003	836	717	627	557	501	456	418	386	358	334	313
	S	405	856	2868	1912	1434	1147	956	819	717	637	574	521	478	441	410	382	358
240	T	355	749	2510	1673	1255	1004	836	717	627	557	502	456	418	386	358	334	313
	S	405	856	2868	1912	1434	1147	956	819	717	637	574	521	478	441	410	382	358
$k_t \times b$ (-)		0,0	16,7	33,4	50,1	66,8	83,5	100,2	116,9	133,6	150,3	167,0	183,7	200,3	217,0	233,7	250,4	267,1

Characteristic load-carrying capacity $F_{4/5,Rk}$ (N) for two angle brackets

b / e (mm)		0	20	40	60	80	100	120	140	160	180	200	220	240	260	280	300	320
0	T	15000	15000	15000	15000	15000	15000	15000	15000	15000	15000	15000	15000	15000	15000	15000	15000	15000
	S	-	-	-	-	-	-	-	-	-	-	-	-	-	-	-	-	-
20	T	15000	9945	4973	3315	2486	1989	1658	1421	1243	1105	995	904	829	765	710	663	622
	S	-	250	125	83	62	50	41	35	31	27	25	22	20	19	17	16	15
40	T	15000	15000	9945	6630	4973	3978	3315	2841	2486	2210	1989	1808	1658	1530	1421	1326	1243
	S	-	501	250	167	125	100	83	71	62	55	50	45	41	38	35	33	31
60	T	15000	15000	14918	9945	7459	5967	4973	4262	3729	3315	2984	2712	2486	2295	2131	1989	1865
	S	-	751	375	250	187	150	125	107	93	83	75	68	62	57	53	50	46
80	T	15000	15000	15000	13260	9945	7956	6630	5683	4973	4420	3978	3616	3315	3060	2841	2652	2486
	S	-	1002	501	334	250	200	167	143	125	111	100	91	83	77	71	66	62
100	T	15000	15000	15000	15000	12431	9945	8288	7104	6216	5525	4973	4520	4144	3825	3552	3315	3108
	S	-	1253	626	417	313	250	208	179	156	139	125	113	104	96	89	83	78
120	T	15000	15000	15000	15000	14918	11934	9945	8524	7459	6630	5967	5425	4973	4590	4262	3978	3729
	S	-	1503	751	501	375	300	250	214	187	167	150	136	125	115	107	100	93
140	T	15000	15000	15000	15000	15000	13923	11603	9945	8702	7735	6962	6329	5801	5355	4973	4641	4351
	S	-	1754	877	584	438	350	292	250	219	194	175	159	146	134	125	116	109
160	T	15000	15000	15000	15000	15000	13260	11366	9945	8840	7956	7233	6630	6120	5683	5304	4973	4733
	S	-	2004	1002	668	501	400	334	286	250	222	200	182	167	154	143	133	125
180	T	15000	15000	15000	15000	15000	14918	12786	11188	9945	8951	8137	7459	6885	6393	5967	5594	5354
	S	-	2255	1127	751	563	451	375	322	281	250	225	205	187	173	161	150	140
200	T	15000	15000	15000	15000	15000	15000	14207	12431	11050	9945	9041	8288	7650	7104	6630	6216	5973
	S	-	2506	1253	835	626	501	417	358	313	278	250	227	208	192	179	167	156
220	T	15000	15000	15000	15000	15000	15000	15000	13674	12155	10940	9945	9116	8415	7814	7293	6837	6593
	S	-	2756	1378	918	689	551	459	393	344	306	275	250	229	212	196	183	172
240	T	15000	15000	15000	15000	15000	15000	15000	14918	13260	11934	10849	9945	9180	8524	7956	7459	7041
	S	-	3007	1503	1002	751	601	501	429	375	334	300	273	250	231	214	200	187
$k_t \times b$ (-)		0,0	192,7	385,5	578,2	770,9	963,6	1156,4	1349,1	1541,8	1734,5	1927,3	2120,0	2312,7	2505,5	2698,2	2890,9	3083,6

TTM: Timber-Timber-Maximum | TTP: Timber-Timber-Partial | TCM: Timber-Concrete-Maximum | TCP: Timber-Concrete-Partial

T: $F_{1,T,Rk}$ load-carrying capacity of timber | S: $F_{1,S,Rk}$ load-carrying capacity of steel

Table B. 132 Angle bracket type 5501SA4, Variant TCP, Fastener Profiled nail A4 4x40, Density 350 kg/m³Characteristic load-carrying capacity $F_{1,Rk}$ (N) for one / two angle brackets

angle bracket	1													2	
f (mm)	0	10	20	30	40	50	60	70	80	90	100	110	120	0	
$F_{1,Rk}$	T	6560	810	405	270	203	162	135	116	101	89	80	73	67	13120
	S	250	210	181	160	142	128	117	107	99	93	87	81	77	500
k_t (-)	9,6	11,5	13,3	15,1	16,9	18,7	20,5	22,4	24,2	26,0	27,8	29,6	31,5	4,8	

Characteristic load-carrying capacity $F_{2/3,Rk}$ (N) for one / two angle brackets

angle bracket	1	2	
$F_{2/3,Rk}$	T	1090	2180
	S	-	-

Characteristic load-carrying capacity $F_{4,Rk}$ (N) for one angle bracket

e (mm)	0	20	40	60	80	100	120	140	160	180	200	220	240	260	280	300	320
$F_{4,Rk}$	T	-	-	4050	368	193	130	98	79	66	57	49	44	40	36	33	28
	S	-	664	332	221	166	133	111	95	83	74	66	60	55	51	47	42
k_t (-)	0,0	3,6	7,3	10,9	14,5	18,2	21,8	25,5	29,1	32,7	36,4	40,0	43,6	47,3	50,9	54,5	58,2

Characteristic load-carrying capacity $F_{5,Rk}$ (N) for one angle bracket

b / e (mm)	0	20	40	60	80	100	120	140	160	180	200	220	240	260	280	300	320
0	T	213	449	1507	1004	753	602	502	430	376	334	301	274	251	231	215	200
	S	405	856	2868	1912	1434	1147	956	819	717	637	574	521	478	441	410	382
20	T	213	449	1369	913	684	547	456	391	342	304	273	249	228	210	195	182
	S	405	856	2868	1912	1434	1147	956	819	717	637	574	521	478	441	410	382
40	T	213	449	1469	979	734	587	489	419	367	326	293	267	244	226	209	195
	S	405	856	2868	1912	1434	1147	956	819	717	637	574	521	478	441	410	382
60	T	213	449	1490	993	745	596	496	425	372	331	298	270	248	229	212	198
	S	405	856	2868	1912	1434	1147	956	819	717	637	574	521	478	441	410	382
80	T	213	449	1497	998	748	599	499	427	374	332	299	272	249	230	213	199
	S	405	856	2868	1912	1434	1147	956	819	717	637	574	521	478	441	410	382
100	T	213	449	1501	1000	750	600	500	428	375	333	300	272	250	230	214	200
	S	405	856	2868	1912	1434	1147	956	819	717	637	574	521	478	441	410	382
120	T	213	449	1503	1002	751	601	501	429	375	334	300	273	250	231	214	200
	S	405	856	2868	1912	1434	1147	956	819	717	637	574	521	478	441	410	382
140	T	213	449	1504	1002	752	601	501	429	376	334	300	273	250	231	214	200
	S	405	856	2868	1912	1434	1147	956	819	717	637	574	521	478	441	410	382
160	T	213	449	1505	1003	752	602	501	430	376	334	301	273	250	231	215	200
	S	405	856	2868	1912	1434	1147	956	819	717	637	574	521	478	441	410	382
180	T	213	449	1505	1003	752	602	501	430	376	334	301	273	250	231	215	200
	S	405	856	2868	1912	1434	1147	956	819	717	637	574	521	478	441	410	382
200	T	213	449	1505	1003	752	602	501	430	376	334	301	273	250	231	215	200
	S	405	856	2868	1912	1434	1147	956	819	717	637	574	521	478	441	410	382
220	T	213	449	1506	1004	753	602	502	430	376	334	301	273	251	231	215	200
	S	405	856	2868	1912	1434	1147	956	819	717	637	574	521	478	441	410	382
240	T	213	449	1506	1004	753	602	502	430	376	334	301	273	251	231	215	200
	S	405	856	2868	1912	1434	1147	956	819	717	637	574	521	478	441	410	382
$k_t \times b$ (-)	0,0	16,7	33,4	50,1	66,8	83,5	100,2	116,9	133,6	150,3	167,0	183,7	200,3	217,0	233,7	250,4	267,1

Characteristic load-carrying capacity $F_{4/5,Rk}$ (N) for two angle brackets

b / e (mm)	0	20	40	60	80	100	120	140	160	180	200	220	240	260	280	300	320
0	T	7199	7199	7199	7199	7199	7199	7199	7199	7199	7199	7199	7199	7199	7199	7199	7199
	S	-	-	-	-	-	-	-	-	-	-	-	-	-	-	-	-
20	T	7199	6560	3280	2187	1640	1312	1093	937	820	729	656	596	547	505	469	437
	S	-	250	125	83	62	50	41	35	31	27	25	22	20	19	17	16
40	T	7199	7200	6560	4373	3280	2624	2187	1874	1640	1458	1312	1193	1093	1009	937	875
	S	-	501	250	167	125	100	83	71	62	55	50	45	41	38	35	33
60	T	7199	7200	7200	6560	4920	3936	3280	2811	2460	2187	1968	1789	1640	1514	1406	1312
	S	-	751	375	250	187	150	125	107	93	83	75	68	62	57	53	50
80	T	7199	7200	7200	7200	6560	5248	4373	3749	3280	2916	2624	2385	2187	2018	1874	1749
	S	-	1002	501	334	250	200	167	143	125	111	100	91	83	77	71	66
100	T	7199	7200	7200	7200	7200	6560	5467	4686	4100	3644	3280	2982	2733	2523	2343	2187
	S	-	1253	626	417	313	250	208	179	156	139	125	113	104	96	89	83
120	T	7199	7200	7200	7200	7200	7200	6560	5623	4920	4373	3936	3578	3280	3028	2811	2624
	S	-	1503	751	501	375	300	250	214	187	167	150	136	125	115	107	100
140	T	7199	7200	7200	7200	7200	7200	6560	5740	5102	4592	4175	3827	3532	3280	3061	2870
	S	-	1754	877	584	438	350	292	250	219	194	175	159	146	134	125	116
160	T	7199	7200	7200	7200	7200	7200	7200	6560	5831	5248	4771	4373	4037	3749	3499	3280
	S	-	2004	1002	668	501	400	334	286	250	222	200	182	167	154	143	133
180	T	7199	7200	7200	7200	7200	7200	7200	7200	6560	5904	5367	4920	4542	4217	3936	3690
	S	-	2255	1127	751	563	451	375	322	281	250	225	205	187	173	161	150
200	T	7199	7200	7200	7200	7200	7200	7200	7200	7200	6560	5964	5467	5046	4686	4373	4100
	S	-	2506	1253	835	626	501	417	358	313	278	250	227	208	192	179	167
220	T	7199	7200	7200	7200	7200	7200	7200	7200	7200	7200	7200	6560	6013	5551	5154	4811
	S	-	2756	1378	918	689	551	459	393	344	306	275	250	229	212	196	183
240	T	7199	7200	7200	7200	7200	7200	7200	7200	7200	7200	7200	7156	6560	6055	5623	5248
	S	-	3007	1503	1002	751	601	501	429	375	334	300	273	250	231	214	200
$k_t \times b$ (-)	0,0	192,7	385,5	578,2	770,9	963,6	1156,4	1349,1	1541,8	1734,5	1927,3	2120,0	2312,7	2505,5	2698,2	2890,9	3083,6

TTM: Timber-Timber-Maximum | TTP: Timber-Timber-Partial | TCM: Timber-Concrete-Maximum | TCP: Timber-Concrete-Partial

T: $F_{1,T,Rk}$ load-carrying capacity of timber | S: $F_{1,S,Rk}$ load-carrying capacity of steel

Table B. 133 Angle bracket type 5501SA4, Variant TCP, Fastener Profiled nail A4 4x60, Density 350 kg/m³Characteristic load-carrying capacity $F_{1,Rk}$ (N) for one / two angle brackets

angle bracket		1													2
f (mm)		0	10	20	30	40	50	60	70	80	90	100	110	120	0
$F_{1,Rk}$	T	7956	1350	675	450	338	270	225	193	169	150	135	123	113	15912
	S	250	210	181	160	142	128	117	107	99	92	86	81	76	500
k_t (-)		9,6	11,5	13,3	15,1	16,9	18,7	20,5	22,4	24,2	26,0	27,8	29,6	31,5	4,8

Characteristic load-carrying capacity $F_{2/3,Rk}$ (N) for one / two angle brackets

angle bracket		1	2
$F_{2/3,Rk}$	T	1630	3260
	S	-	-

Characteristic load-carrying capacity $F_{4,Rk}$ (N) for one angle bracket

e (mm)		0	20	40	60	80	100	120	140	160	180	200	220	240	260	280	300	320
$F_{4,Rk}$	T	-	-	6750	614	321	218	165	132	111	95	83	74	67	61	56	52	48
	S	-	664	332	221	166	132	110	94	83	73	66	60	55	51	47	44	41
k_t (-)		0,0	3,6	7,3	10,9	14,5	18,2	21,8	25,5	29,1	32,7	36,4	40,0	43,6	47,3	50,9	54,5	58,2

Characteristic load-carrying capacity $F_{5,Rk}$ (N) for one angle bracket

b / e (mm)		0	20	40	60	80	100	120	140	160	180	200	220	240	260	280	300	320
0	T	355	749	2512	1675	1256	1005	837	717	628	558	502	456	418	386	358	334	314
	S	405	856	2868	1912	1434	1147	956	819	717	637	574	521	478	441	410	382	358
20	T	355	749	2124	1416	1062	849	708	606	531	472	424	386	354	326	303	283	265
	S	405	856	2868	1912	1434	1147	956	819	717	637	574	521	478	441	410	382	358
40	T	355	749	2395	1597	1197	958	798	684	598	532	479	435	399	368	342	319	299
	S	405	856	2868	1912	1434	1147	956	819	717	637	574	521	478	441	410	382	358
60	T	355	749	2458	1639	1229	983	819	702	614	546	491	447	409	378	351	327	307
	S	405	856	2868	1912	1434	1147	956	819	717	637	574	521	478	441	410	382	358
80	T	355	749	2481	1654	1240	992	827	709	620	551	496	451	413	381	354	330	310
	S	405	856	2868	1912	1434	1147	956	819	717	637	574	521	478	441	410	382	358
100	T	355	749	2492	1661	1246	997	830	712	623	553	498	453	415	383	356	332	311
	S	405	856	2868	1912	1434	1147	956	819	717	637	574	521	478	441	410	382	358
120	T	355	749	2498	1665	1249	999	832	713	624	555	499	454	416	384	356	333	312
	S	405	856	2868	1912	1434	1147	956	819	717	637	574	521	478	441	410	382	358
140	T	355	749	2502	1668	1251	1000	834	714	625	556	500	454	417	384	357	333	312
	S	405	856	2868	1912	1434	1147	956	819	717	637	574	521	478	441	410	382	358
160	T	355	749	2504	1669	1252	1001	834	715	626	556	500	455	417	385	357	333	313
	S	405	856	2868	1912	1434	1147	956	819	717	637	574	521	478	441	410	382	358
180	T	355	749	2506	1670	1253	1002	835	716	626	556	501	455	417	385	358	334	313
	S	405	856	2868	1912	1434	1147	956	819	717	637	574	521	478	441	410	382	358
200	T	355	749	2507	1671	1253	1003	835	716	626	557	501	455	417	385	358	334	313
	S	405	856	2868	1912	1434	1147	956	819	717	637	574	521	478	441	410	382	358
220	T	355	749	2508	1672	1254	1003	836	716	627	557	501	456	418	385	358	334	313
	S	405	856	2868	1912	1434	1147	956	819	717	637	574	521	478	441	410	382	358
240	T	355	749	2509	1672	1254	1003	836	716	627	557	501	456	418	386	358	334	313
	S	405	856	2868	1912	1434	1147	956	819	717	637	574	521	478	441	410	382	358
$k_t \times b$ (-)		0,0	16,7	33,4	50,1	66,8	83,5	100,2	116,9	133,6	150,3	167,0	183,7	200,3	217,0	233,7	250,4	267,1

Characteristic load-carrying capacity $F_{4/5,Rk}$ (N) for two angle brackets

b / e (mm)		0	20	40	60	80	100	120	140	160	180	200	220	240	260	280	300	320
0	T	12000	12000	12000	12000	12000	12000	12000	12000	12000	12000	12000	12000	12000	12000	12000	12000	12000
	S	-	-	-	-	-	-	-	-	-	-	-	-	-	-	-	-	-
20	T	12000	7956	3978	2652	1989	1591	1326	1137	995	884	796	723	663	612	568	530	497
	S	-	250	125	83	62	50	41	35	31	27	25	22	20	19	17	16	15
40	T	12000	12000	7956	5304	3978	3182	2652	2273	1989	1768	1591	1447	1326	1224	1137	1061	995
	S	-	501	250	167	125	100	83	71	62	55	50	45	41	38	35	33	31
60	T	12000	12000	11934	7956	5967	4774	3978	3410	2984	2652	2387	2170	1989	1836	1705	1591	1492
	S	-	751	375	250	187	150	125	107	93	83	75	68	62	57	53	50	46
80	T	12000	12000	12000	10608	7956	6365	5304	4546	3978	3536	3182	2893	2652	2448	2273	2122	1989
	S	-	1002	501	334	250	200	167	143	125	111	100	91	83	77	71	66	62
100	T	12000	12000	12000	12000	9945	7956	6630	5683	4973	4420	3978	3616	3315	3060	2841	2652	2486
	S	-	1253	626	417	313	250	208	179	156	139	125	113	104	96	89	83	78
120	T	12000	12000	12000	12000	11934	9547	7956	6819	5967	5304	4774	4340	3978	3672	3410	3182	2984
	S	-	1503	751	501	375	300	250	214	187	167	150	136	125	115	107	100	93
140	T	12000	12000	12000	12000	12000	11138	9282	7956	6962	6188	5569	5063	4641	4284	3978	3713	3481
	S	-	1754	877	584	438	350	292	250	219	194	175	159	146	134	125	116	109
160	T	12000	12000	12000	12000	12000	10608	9093	7956	7072	6365	5786	5304	4896	4546	4243	3978	3788
	S	-	2004	1002	668	501	400	334	286	250	222	200	182	167	154	143	133	125
180	T	12000	12000	12000	12000	12000	11934	10229	8951	7956	7160	6509	5967	5508	5115	4774	4475	4275
	S	-	2255	1127	751	563	451	375	322	281	250	225	205	187	173	161	150	140
200	T	12000	12000	12000	12000	12000	12000	11366	9945	8840	7956	7233	6630	6120	5683	5304	4973	4733
	S	-	2506	1253	835	626	501	417	358	313	278	250	227	208	192	179	167	156
220	T	12000	12000	12000	12000	12000	12000	12000	10940	9724	8752	7956	7293	6732	6251	5834	5470	5270
	S	-	2756	1378	918	689	551	459	393	344	306	275	250	229	212	196	183	172
240	T	12000	12000	12000	12000	12000	12000	12000	11934	10608	9547	8679	7956	7344	6819	6365	5967	5677
	S	-	3007	1503	1002	751	601	501	429	375	334	300	273	250	231	214	200	187
$k_t \times b$ (-)		0,0	192,7	385,5	578,2	770,9	963,6	1156,4	1349,1	1541,8	1734,5	1927,3	2120,0	2312,7	2505,5	2698,2	2890,9	3083,6

TTM: Timber-Timber-Maximum | TTP: Timber-Timber-Partial | TCM: Timber-Concrete-Maximum | TCP: Timber-Concrete-Partial

T: $F_{1,T,Rk}$ load-carrying capacity of timber | S: $F_{1,S,Rk}$ load-carrying capacity of steel

Table B. 134 Angle bracket type 5501SA4, Variant TTM, Fastener Profiled nail A4 4x40, Density 350 kg/m³Characteristic load-carrying capacity $F_{1,Rk}$ (N) for one / two angle brackets

angle bracket		1													2
f (mm)		0	10	20	30	40	50	60	70	80	90	100	110	120	0
$F_{1,Rk}$	T	1230	806	404	269	202	161	134	115	101	89	80	73	67	2460
	S	2107	1541	770	514	385	308	257	220	193	171	154	140	128	4214

Characteristic load-carrying capacity $F_{2/3,Rk}$ (N) for one / two angle brackets

angle bracket		1	2
$F_{2/3,Rk}$	T	3280	6560
	S	-	-

Characteristic load-carrying capacity $F_{4,Rk}$ (N) for one angle bracket

e (mm)		0	20	40	60	80	100	120	140	160	180	200	220	240	260	280	300	320
$F_{4,Rk}$	T	11480	2291	1163	368	192	130	98	79	66	57	49	44	40	36	33	30	28
	S	-	4003	2002	700	367	249	188	151	126	109	95	85	76	69	64	59	55

Characteristic load-carrying capacity $F_{5,Rk}$ (N) for one angle bracket

b / e (mm)		0	20	40	60	80	100	120	140	160	180	200	220	240	260	280	300	320
0	T	213	449	1507	1004	753	602	502	430	376	334	301	274	251	231	215	200	188
	S	405	856	2868	1912	1434	1147	956	819	717	637	574	521	478	441	410	382	358
20	T	213	449	1414	943	707	565	471	404	353	314	282	257	235	217	202	188	176
	S	405	856	2868	1912	1434	1147	956	819	717	637	574	521	478	441	410	382	358
40	T	213	449	1482	988	741	593	494	423	370	329	296	269	247	228	211	197	185
	S	405	856	2868	1912	1434	1147	956	819	717	637	574	521	478	441	410	382	358
60	T	213	449	1496	997	748	598	498	427	374	332	299	272	249	230	213	199	187
	S	405	856	2868	1912	1434	1147	956	819	717	637	574	521	478	441	410	382	358
80	T	213	449	1501	1000	750	600	500	428	375	333	300	272	250	230	214	200	187
	S	405	856	2868	1912	1434	1147	956	819	717	637	574	521	478	441	410	382	358
100	T	213	449	1503	1002	751	601	501	429	375	334	300	273	250	231	214	200	187
	S	405	856	2868	1912	1434	1147	956	819	717	637	574	521	478	441	410	382	358
120	T	213	449	1504	1003	752	601	501	429	376	334	300	273	250	231	214	200	188
	S	405	856	2868	1912	1434	1147	956	819	717	637	574	521	478	441	410	382	358
140	T	213	449	1505	1003	752	602	501	430	376	334	301	273	250	231	215	200	188
	S	405	856	2868	1912	1434	1147	956	819	717	637	574	521	478	441	410	382	358
160	T	213	449	1505	1003	752	602	501	430	376	334	301	273	250	231	215	200	188
	S	405	856	2868	1912	1434	1147	956	819	717	637	574	521	478	441	410	382	358
180	T	213	449	1506	1004	753	602	502	430	376	334	301	273	251	231	215	200	188
	S	405	856	2868	1912	1434	1147	956	819	717	637	574	521	478	441	410	382	358
200	T	213	449	1506	1004	753	602	502	430	376	334	301	273	251	231	215	200	188
	S	405	856	2868	1912	1434	1147	956	819	717	637	574	521	478	441	410	382	358
220	T	213	449	1506	1004	753	602	502	430	376	334	301	273	251	231	215	200	188
	S	405	856	2868	1912	1434	1147	956	819	717	637	574	521	478	441	410	382	358
240	T	213	449	1506	1004	753	602	502	430	376	334	301	273	251	231	215	200	188
	S	405	856	2868	1912	1434	1147	956	819	717	637	574	521	478	441	410	382	358

Characteristic load-carrying capacity $F_{4/5,Rk}$ (N) for two angle brackets

b / e (mm)		0	20	40	60	80	100	120	140	160	180	200	220	240	260	280	300	320
0	T	8999	8999	8999	8999	8999	8999	8999	8999	8999	8999	8999	8999	8999	8999	8999	8999	8999
	S	-	-	-	-	-	-	-	-	-	-	-	-	-	-	-	-	-
20	T	8999	1229	615	410	307	246	205	175	153	136	123	111	102	94	87	82	76
	S	-	2107	1053	702	527	421	351	301	263	234	211	192	176	162	150	140	132
40	T	8999	2447	1229	820	615	492	410	351	307	273	246	223	205	189	175	164	153
	S	-	4214	2107	1405	1053	843	702	602	527	468	421	383	351	324	301	281	263
60	T	8999	3645	1840	1229	922	738	615	527	461	410	369	335	307	284	263	246	230
	S	-	6321	3160	2107	1580	1264	1053	903	790	702	632	575	527	486	451	421	395
80	T	8999	4814	2447	1637	1229	983	820	703	615	546	492	447	410	378	351	328	307
	S	-	8428	4214	2809	2107	1686	1405	1204	1053	936	843	766	702	648	602	562	527
100	T	8999	5944	3050	2043	1535	1229	1024	878	768	683	615	559	512	473	439	410	384
	S	-	10535	5267	3512	2634	2107	1756	1505	1317	1171	1053	958	878	810	752	702	658
120	T	8999	7030	3645	2447	1840	1474	1229	1053	922	820	738	671	615	567	527	492	461
	S	-	12641	6321	4214	3160	2528	2107	1806	1580	1405	1264	1149	1053	972	903	843	790
140	T	8999	8067	4234	2849	2144	1718	1433	1229	1075	956	861	782	717	662	615	574	538
	S	-	14748	7374	4916	3687	2950	2458	2107	1844	1639	1475	1341	1229	1134	1053	983	922
160	T	8999	8916	4814	3249	2447	1962	1637	1404	1229	1092	983	894	820	757	703	656	615
	S	-	16855	8428	5618	4214	3371	2809	2408	2107	1873	1686	1532	1405	1297	1204	1124	1053
180	T	8999	8933	5384	3645	2749	2205	1840	1578	1382	1229	1106	1006	922	851	790	738	692
	S	-	18962	9481	6321	4741	3792	3160	2709	2370	2107	1896	1724	1580	1459	1354	1264	1185
200	T	8999	8946	5944	4039	3050	2447	2043	1753	1535	1365	1229	1117	1024	946	878	820	768
	S	-	21069	10535	7023	5267	4214	3512	3010	2634	2341	2107	1915	1756	1621	1505	1405	1317
220	T	8999	8955	6493	4428	3348	2689	2245	1927	1687	1501	1351	1229	1126	1040	966	901	845
	S	-	23176	11588	7725	5794	4635	3863	3311	2897	2575	2318	2107	1931	1783	1655	1545	1448
240	T	8999	8962	7030	4814	3645	2930	2447	2101	1840	1637	1474	1340	1229	1134	1053	983	922
	S	-	25283	12641	8428	6321	5057	4214	3612	3160	2809	2528	2298	2107	1945	1806	1686	1580

TTM: Timber-Timber-Maximum | TTP: Timber-Timber-Partial | TCM: Timber-Concrete-Maximum | TCP: Timber-Concrete-Partial

T: $F_{1,T,Rk}$ load-carrying capacity of timber | S: $F_{1,S,Rk}$ load-carrying capacity of steel

Table B. 135 Angle bracket type 5501SA4, Variant TTM, Fastener Profiled nail A4 4x60, Density 350 kg/m³Characteristic load-carrying capacity $F_{T,Rk}$ (N) for one / two angle brackets

angle bracket		1													2
f (mm)		0	10	20	30	40	50	60	70	80	90	100	110	120	0
$F_{T,Rk}$	T	2051	1337	673	449	337	269	224	192	168	149	134	122	112	4102
	S	2107	1541	770	514	385	308	257	220	193	171	154	140	128	4214

Characteristic load-carrying capacity $F_{2/3,Rk}$ (N) for one / two angle brackets

angle bracket		1	2
$F_{2/3,Rk}$	T	4220	8440
	S	-	-

Characteristic load-carrying capacity $F_{4,Rk}$ (N) for one angle bracket

e (mm)		0	20	40	60	80	100	120	140	160	180	200	220	240	260	280	300	320
$F_{4,Rk}$	T	13923	3753	1930	613	321	217	164	132	110	95	83	74	66	60	55	51	47
	S	-	4003	2002	700	367	249	188	151	126	109	95	85	76	69	64	59	55

Characteristic load-carrying capacity $F_{5,Rk}$ (N) for one angle bracket

b / e (mm)		0	20	40	60	80	100	120	140	160	180	200	220	240	260	280	300	320
0	T	355	749	2512	1675	1256	1005	837	717	628	558	502	456	418	386	358	334	314
	S	405	856	2868	1912	1434	1147	956	819	717	637	574	521	478	441	410	382	358
20	T	355	749	2242	1494	1121	896	747	640	560	498	448	407	373	344	320	298	280
	S	405	856	2868	1912	1434	1147	956	819	717	637	574	521	478	441	410	382	358
40	T	355	749	2435	1623	1217	974	811	695	608	541	487	442	405	374	347	324	304
	S	405	856	2868	1912	1434	1147	956	819	717	637	574	521	478	441	410	382	358
60	T	355	749	2477	1651	1238	991	825	707	619	550	495	450	412	381	353	330	309
	S	405	856	2868	1912	1434	1147	956	819	717	637	574	521	478	441	410	382	358
80	T	355	749	2492	1661	1246	997	830	712	623	553	498	453	415	383	356	332	311
	S	405	856	2868	1912	1434	1147	956	819	717	637	574	521	478	441	410	382	358
100	T	355	749	2499	1666	1249	999	833	714	624	555	499	454	416	384	357	333	312
	S	405	856	2868	1912	1434	1147	956	819	717	637	574	521	478	441	410	382	358
120	T	355	749	2503	1669	1251	1001	834	715	625	556	500	455	417	385	357	333	312
	S	405	856	2868	1912	1434	1147	956	819	717	637	574	521	478	441	410	382	358
140	T	355	749	2505	1670	1252	1002	835	715	626	556	501	455	417	385	357	334	313
	S	405	856	2868	1912	1434	1147	956	819	717	637	574	521	478	441	410	382	358
160	T	355	749	2507	1671	1253	1003	835	716	626	557	501	455	417	385	358	334	313
	S	405	856	2868	1912	1434	1147	956	819	717	637	574	521	478	441	410	382	358
180	T	355	749	2508	1672	1254	1003	836	716	627	557	501	456	418	385	358	334	313
	S	405	856	2868	1912	1434	1147	956	819	717	637	574	521	478	441	410	382	358
200	T	355	749	2509	1672	1254	1003	836	716	627	557	501	456	418	386	358	334	313
	S	405	856	2868	1912	1434	1147	956	819	717	637	574	521	478	441	410	382	358
220	T	355	749	2509	1673	1254	1003	836	717	627	557	501	456	418	386	358	334	313
	S	405	856	2868	1912	1434	1147	956	819	717	637	574	521	478	441	410	382	358
240	T	355	749	2510	1673	1255	1004	836	717	627	557	502	456	418	386	358	334	313
	S	405	856	2868	1912	1434	1147	956	819	717	637	574	521	478	441	410	382	358

Characteristic load-carrying capacity $F_{4/5,Rk}$ (N) for two angle brackets

b / e (mm)		0	20	40	60	80	100	120	140	160	180	200	220	240	260	280	300	320
0	T	15000	15000	15000	15000	15000	15000	15000	15000	15000	15000	15000	15000	15000	15000	15000	15000	15000
	S	-	-	-	-	-	-	-	-	-	-	-	-	-	-	-	-	-
20	T	15000	2046	1025	683	512	410	341	293	256	227	205	186	170	157	146	136	128
	S	-	2107	1053	702	527	421	351	301	263	234	211	192	176	162	150	140	132
40	T	15000	4059	2046	1366	1025	820	683	586	512	455	410	372	341	315	293	273	256
	S	-	4214	2107	1405	1053	843	702	602	527	468	421	383	351	324	301	281	263
60	T	15000	6009	3058	2046	1536	1229	1025	878	769	683	615	559	512	473	439	410	384
	S	-	6321	3160	2107	1580	1264	1053	903	790	702	632	575	527	486	451	421	395
80	T	15000	7871	4059	2722	2046	1638	1366	1171	1025	911	820	745	683	631	586	546	512
	S	-	8428	4214	2809	2107	1686	1405	1204	1053	936	843	766	702	648	602	562	527
100	T	15000	9625	5044	3393	2553	2046	1706	1463	1280	1138	1025	932	854	788	732	683	640
	S	-	10535	5267	3512	2634	2107	1756	1505	1317	1171	1053	958	878	810	752	702	658
120	T	15000	11258	6009	4059	3058	2452	2046	1754	1536	1366	1229	1118	1025	946	878	820	769
	S	-	12641	6321	4214	3160	2528	2107	1806	1580	1405	1264	1149	1053	972	903	843	790
140	T	15000	12763	6952	4717	3560	2857	2384	2046	1791	1593	1434	1304	1195	1103	1025	956	897
	S	-	14748	7374	4916	3687	2950	2458	2107	1844	1639	1475	1341	1229	1134	1053	983	922
160	T	15000	14139	7871	5368	4059	3259	2722	2336	2046	1819	1638	1489	1366	1261	1171	1093	1025
	S	-	16855	8428	5618	4214	3371	2809	2408	2107	1873	1686	1532	1405	1297	1204	1124	1053
180	T	15000	14793	8762	6009	4553	3660	3058	2625	2300	2046	1842	1675	1536	1418	1317	1229	1153
	S	-	18962	9481	6321	4741	3792	3160	2709	2370	2107	1896	1724	1580	1459	1354	1264	1185
200	T	15000	14832	9625	6641	5044	4059	3393	2914	2553	2271	2046	1860	1706	1575	1463	1366	1280
	S	-	21069	10535	7023	5267	4214	3512	3010	2634	2341	2107	1915	1756	1621	1505	1405	1317
220	T	15000	14860	10457	7262	5529	4455	3727	3202	2806	2497	2249	2046	1876	1732	1609	1502	1408
	S	-	23176	11588	7725	5794	4635	3863	3311	2897	2575	2318	2107	1931	1783	1655	1545	1448
240	T	15000	14882	11258	7871	6009	4848	4059	3489	3058	2722	2452	2230	2046	1889	1754	1638	1536
	S	-	25283	12641	8428	6321	5057	4214	3612	3160	2809	2528	2298	2107	1945	1806	1686	1580

TTM: Timber-Timber-Maximum | TTP: Timber-Timber-Partial | TCM: Timber-Concrete-Maximum | TCP: Timber-Concrete-Partial

T: $F_{T,Rk}$ load-carrying capacity of timber | S: $F_{S,Rk}$ load-carrying capacity of steel

Table B. 136 Angle bracket type 5501SA4, Variant TTP, Fastener Profiled nail A4 4x40, Density 350 kg/m³Characteristic load-carrying capacity $F_{T,Rk}$ (N) for one / two angle brackets

angle bracket		1													2
f (mm)		0	10	20	30	40	50	60	70	80	90	100	110	120	0
$F_{T,Rk}$	T	1089	803	404	269	202	161	134	115	101	89	80	73	67	2178
	S	4629	1541	770	514	385	308	257	220	193	171	154	140	128	9257

Characteristic load-carrying capacity $F_{2/3,Rk}$ (N) for one / two angle brackets

angle bracket		1	2
$F_{2/3,Rk}$	T	2660	5320
	S	-	-

Characteristic load-carrying capacity $F_{4,Rk}$ (N) for one angle bracket

e (mm)		0	20	40	60	80	100	120	140	160	180	200	220	240	260	280	300	320
$F_{4,Rk}$	T	6559	1974	1022	368	192	130	98	79	66	57	49	44	40	36	33	30	28
	S	-	5735	2868	700	367	249	188	151	126	109	95	85	76	69	64	59	55

Characteristic load-carrying capacity $F_{5,Rk}$ (N) for one angle bracket

b / e (mm)		0	20	40	60	80	100	120	140	160	180	200	220	240	260	280	300	320
0	T	213	449	671	448	337	269	224	192	168	149	134	122	112	103	96	89	84
	S	405	856	2868	1912	1434	1147	956	819	717	637	574	521	478	441	410	382	358
20	T	213	449	1369	913	684	547	456	391	342	304	273	249	228	210	195	182	171
	S	405	856	2868	1912	1434	1147	956	819	717	637	574	521	478	441	410	382	358
40	T	213	449	1469	979	734	587	489	419	367	326	293	267	244	226	209	195	183
	S	405	856	2868	1912	1434	1147	956	819	717	637	574	521	478	441	410	382	358
60	T	213	449	1490	993	745	596	496	425	372	331	298	270	248	229	212	198	186
	S	405	856	2868	1912	1434	1147	956	819	717	637	574	521	478	441	410	382	358
80	T	213	449	1497	998	748	599	499	427	374	332	299	272	249	230	213	199	187
	S	405	856	2868	1912	1434	1147	956	819	717	637	574	521	478	441	410	382	358
100	T	213	449	1501	1000	750	600	500	428	375	333	300	272	250	230	214	200	187
	S	405	856	2868	1912	1434	1147	956	819	717	637	574	521	478	441	410	382	358
120	T	213	449	1503	1002	751	601	501	429	375	334	300	273	250	231	214	200	187
	S	405	856	2868	1912	1434	1147	956	819	717	637	574	521	478	441	410	382	358
140	T	213	449	1504	1002	752	601	501	429	376	334	300	273	250	231	214	200	188
	S	405	856	2868	1912	1434	1147	956	819	717	637	574	521	478	441	410	382	358
160	T	213	449	1505	1003	752	602	501	430	376	334	301	273	250	231	215	200	188
	S	405	856	2868	1912	1434	1147	956	819	717	637	574	521	478	441	410	382	358
180	T	213	449	1505	1003	752	602	501	430	376	334	301	273	250	231	215	200	188
	S	405	856	2868	1912	1434	1147	956	819	717	637	574	521	478	441	410	382	358
200	T	213	449	1505	1003	752	602	501	430	376	334	301	273	250	231	215	200	188
	S	405	856	2868	1912	1434	1147	956	819	717	637	574	521	478	441	410	382	358
220	T	213	449	1506	1004	753	602	502	430	376	334	301	273	251	231	215	200	188
	S	405	856	2868	1912	1434	1147	956	819	717	637	574	521	478	441	410	382	358
240	T	213	449	1506	1004	753	602	502	430	376	334	301	273	251	231	215	200	188
	S	405	856	2868	1912	1434	1147	956	819	717	637	574	521	478	441	410	382	358

Characteristic load-carrying capacity $F_{4/5,Rk}$ (N) for two angle brackets

b / e (mm)		0	20	40	60	80	100	120	140	160	180	200	220	240	260	280	300	320
0	T	7199	7199	7199	7199	7199	7199	7199	7199	7199	7199	7199	7199	7199	7199	7199	7199	7199
	S	-	-	-	-	-	-	-	-	-	-	-	-	-	-	-	-	-
20	T	7199	1085	544	363	272	217	181	155	136	121	108	99	90	83	77	72	68
	S	-	4629	2314	1543	1157	926	771	661	579	514	463	421	386	356	331	309	289
40	T	7199	2149	1085	725	544	435	363	311	272	242	217	198	181	167	155	145	136
	S	-	9257	4629	3086	2314	1851	1543	1322	1157	1029	926	842	771	712	661	617	579
60	T	7199	3171	1621	1085	815	652	544	466	408	363	326	297	272	251	233	217	204
	S	-	13886	6943	4629	3471	2777	2314	1984	1736	1543	1389	1262	1157	1068	992	926	868
80	T	7199	4135	2149	1443	1085	869	725	621	544	483	435	395	363	335	311	290	272
	S	-	18514	9257	6171	4629	3703	3086	2645	2314	2057	1851	1683	1543	1424	1322	1234	1157
100	T	7199	5030	2666	1798	1354	1085	905	776	680	604	544	494	453	418	388	363	340
	S	-	23143	11572	7714	5786	4629	3857	3306	2893	2571	2314	2104	1929	1780	1653	1543	1446
120	T	7199	5850	3171	2149	1621	1300	1085	931	815	725	652	593	544	502	466	435	408
	S	-	27772	13886	9257	6943	5554	4629	3967	3471	3086	2777	2525	2314	2136	1984	1851	1736
140	T	7199	6593	3661	2495	1886	1515	1265	1085	950	845	761	692	634	586	544	508	476
	S	-	32400	16200	10800	8100	6480	5400	4629	4050	3600	3240	2945	2700	2492	2314	2160	2025
160	T	7199	7133	4135	2836	2149	1727	1443	1239	1085	965	869	790	725	669	621	580	544
	S	-	37029	18514	12343	9257	7406	6171	5290	4629	4114	3703	3366	3086	2848	2645	2469	2314
180	T	7199	7147	4592	3171	2409	1939	1621	1392	1220	1085	977	889	815	753	699	652	612
	S	-	41657	20829	13886	10414	8331	6943	5951	5207	4629	4166	3787	3471	3204	2976	2777	2604
200	T	7199	7157	5030	3499	2666	2149	1798	1545	1354	1205	1085	987	905	836	776	725	680
	S	-	46286	23143	15429	11572	9257	7714	6612	5786	5143	4629	4208	3857	3560	3306	3086	2893
220	T	7199	7164	5450	3821	2920	2357	1974	1697	1488	1324	1193	1085	995	919	854	797	747
	S	-	50915	25457	16972	12729	10183	8486	7274	6364	5657	5091	4629	4243	3917	3637	3394	3182
240	T	7199	7170	5850	4135	3171	2564	2149	1849	1621	1443	1300	1183	1085	1002	931	869	815
	S	-	55543	27772	18514	13886	11109	9257	7935	6943	6171	5554	5049	4629	4273	3967	3703	3471

TTM: Timber-Timber-Maximum | TTP: Timber-Timber-Partial | TCM: Timber-Concrete-Maximum | TCP: Timber-Concrete-Partial

T: $F_{T,Rk}$ load-carrying capacity of timber | S: $F_{S,Rk}$ load-carrying capacity of steel

Table B. 137 Angle bracket type 5501SA4, Variant TTP, Fastener Profiled nail A4 4x60, Density 350 kg/m³Characteristic load-carrying capacity $F_{T,Rk}$ (N) for one / two angle brackets

angle bracket		1													2
f (mm)		0	10	20	30	40	50	60	70	80	90	100	110	120	0
$F_{T,Rk}$	T	1815	1330	672	449	337	269	224	192	168	149	134	122	112	3630
	S	4629	1541	770	514	385	308	257	220	193	171	154	140	128	9257

Characteristic load-carrying capacity $F_{2/3,Rk}$ (N) for one / two angle brackets

angle bracket		1	2
$F_{2/3,Rk}$	T	3360	6720
	S	-	-

Characteristic load-carrying capacity $F_{4,Rk}$ (N) for one angle bracket

e (mm)		0	20	40	60	80	100	120	140	160	180	200	220	240	260	280	300	320
$F_{4,Rk}$	T	7955	3165	1685	613	321	217	164	132	110	95	83	74	66	60	55	51	47
	S	-	5735	2868	700	367	249	188	151	126	109	95	85	76	69	64	59	55

Characteristic load-carrying capacity $F_{5,Rk}$ (N) for one angle bracket

b / e (mm)		0	20	40	60	80	100	120	140	160	180	200	220	240	260	280	300	320
0	T	355	749	1113	746	561	449	374	321	281	249	224	204	187	173	160	149	140
	S	405	856	2868	1912	1434	1147	956	819	717	637	574	521	478	441	410	382	358
20	T	355	749	2124	1416	1062	849	708	606	531	472	424	386	354	326	303	283	265
	S	405	856	2868	1912	1434	1147	956	819	717	637	574	521	478	441	410	382	358
40	T	355	749	2395	1597	1197	958	798	684	598	532	479	435	399	368	342	319	299
	S	405	856	2868	1912	1434	1147	956	819	717	637	574	521	478	441	410	382	358
60	T	355	749	2458	1639	1229	983	819	702	614	546	491	447	409	378	351	327	307
	S	405	856	2868	1912	1434	1147	956	819	717	637	574	521	478	441	410	382	358
80	T	355	749	2481	1654	1240	992	827	709	620	551	496	451	413	381	354	330	310
	S	405	856	2868	1912	1434	1147	956	819	717	637	574	521	478	441	410	382	358
100	T	355	749	2492	1661	1246	997	830	712	623	553	498	453	415	383	356	332	311
	S	405	856	2868	1912	1434	1147	956	819	717	637	574	521	478	441	410	382	358
120	T	355	749	2498	1665	1249	999	832	713	624	555	499	454	416	384	356	333	312
	S	405	856	2868	1912	1434	1147	956	819	717	637	574	521	478	441	410	382	358
140	T	355	749	2502	1668	1251	1000	834	714	625	556	500	454	417	384	357	333	312
	S	405	856	2868	1912	1434	1147	956	819	717	637	574	521	478	441	410	382	358
160	T	355	749	2504	1669	1252	1001	834	715	626	556	500	455	417	385	357	333	313
	S	405	856	2868	1912	1434	1147	956	819	717	637	574	521	478	441	410	382	358
180	T	355	749	2506	1670	1253	1002	835	716	626	556	501	455	417	385	358	334	313
	S	405	856	2868	1912	1434	1147	956	819	717	637	574	521	478	441	410	382	358
200	T	355	749	2507	1671	1253	1003	835	716	626	557	501	455	417	385	358	334	313
	S	405	856	2868	1912	1434	1147	956	819	717	637	574	521	478	441	410	382	358
220	T	355	749	2508	1672	1254	1003	836	716	627	557	501	456	418	385	358	334	313
	S	405	856	2868	1912	1434	1147	956	819	717	637	574	521	478	441	410	382	358
240	T	355	749	2509	1672	1254	1003	836	716	627	557	501	456	418	386	358	334	313
	S	405	856	2868	1912	1434	1147	956	819	717	637	574	521	478	441	410	382	358

Characteristic load-carrying capacity $F_{4/5,Rk}$ (N) for two angle brackets

b / e (mm)		0	20	40	60	80	100	120	140	160	180	200	220	240	260	280	300	320
0	T	12000	12000	12000	12000	12000	12000	12000	12000	12000	12000	12000	12000	12000	12000	12000	12000	12000
	S	-	-	-	-	-	-	-	-	-	-	-	-	-	-	-	-	-
20	T	12000	1804	906	604	453	363	302	259	226	201	181	165	151	139	129	121	113
	S	-	4629	2314	1543	1157	926	771	661	579	514	463	421	386	356	331	309	289
40	T	12000	3540	1804	1207	906	725	604	518	453	403	363	330	302	279	259	242	226
	S	-	9257	4629	3086	2314	1851	1543	1322	1157	1029	926	842	771	712	661	617	579
60	T	12000	5153	2684	1804	1356	1086	906	777	680	604	544	494	453	418	388	363	340
	S	-	13886	6943	4629	3471	2777	2314	1984	1736	1543	1389	1262	1157	1068	992	926	868
80	T	12000	6607	3540	2393	1804	1446	1207	1035	906	805	725	659	604	558	518	483	453
	S	-	18514	9257	6171	4629	3703	3086	2645	2314	2057	1851	1683	1543	1424	1322	1234	1157
100	T	12000	7885	4365	2973	2246	1804	1506	1292	1131	1006	906	824	755	697	647	604	567
	S	-	23143	11572	7714	5786	4629	3857	3306	2893	2571	2314	2104	1929	1780	1653	1543	1446
120	T	12000	8989	5153	3540	2684	2158	1804	1548	1356	1207	1086	988	906	836	777	725	680
	S	-	27772	13886	9257	6943	5554	4629	3967	3471	3086	2777	2525	2314	2136	1984	1851	1736
140	T	12000	9931	5901	4094	3116	2510	2099	1804	1580	1406	1267	1152	1056	975	906	846	793
	S	-	32400	16200	10800	8100	6480	5400	4629	4050	3600	3240	2945	2700	2492	2314	2160	2025
160	T	12000	10728	6607	4632	3540	2858	2393	2057	1804	1605	1446	1316	1207	1114	1035	966	906
	S	-	37029	18514	12343	9257	7406	6171	5290	4629	4114	3703	3366	3086	2848	2645	2469	2314
180	T	12000	11400	7268	5153	3957	3201	2684	2309	2026	1804	1625	1479	1356	1253	1164	1086	1019
	S	-	41657	20829	13886	10414	8331	6943	5951	5207	4629	4166	3787	3471	3204	2976	2777	2604
200	T	12000	11865	7885	5657	4365	3540	2973	2560	2246	2001	1804	1641	1506	1391	1292	1207	1131
	S	-	46286	23143	15429	11572	9257	7714	6612	5786	5143	4629	4208	3857	3560	3306	3086	2893
220	T	12000	11888	8458	6141	4764	3874	3258	2808	2466	2198	1981	1804	1655	1529	1420	1326	1244
	S	-	50915	25457	16972	12729	10183	8486	7274	6364	5657	5091	4629	4243	3917	3637	3394	3182
240	T	12000	11906	8989	6607	5153	4203	3540	3054	2684	2393	2158	1965	1804	1666	1548	1446	1356
	S	-	55543	27772	18514	13886	11109	9257	7935	6943	6171	5554	5049	4629	4273	3967	3703	3471

TTM: Timber-Timber-Maximum | TTP: Timber-Timber-Partial | TCM: Timber-Concrete-Maximum | TCP: Timber-Concrete-Partial

T: $F_{T,Rk}$ load-carrying capacity of timber | S: $F_{S,Rk}$ load-carrying capacity of steel

Table B. 138 Angle bracket type 5502SA4, Variant TCM, Fastener Profiled nail A4 4x40, Density 350 kg/m³

Characteristic load-carrying capacity $F_{1,Rk}$ (N) for one / two angle brackets															
angle bracket	1													2	
f (mm)	0	10	20	30	40	50	60	70	80	90	100	110	120	0	
$F_{1,Rk}$	T	8200	450	225	150	113	90	75	64	56	50	45	41	38	16400
	S	28	23	20	18	16	14	13	12	11	10	9	8	8	56
k_t (-)	9,6	11,5	13,3	15,1	16,9	18,7	20,5	22,4	24,2	26,0	27,8	29,6	31,5	4,8	

Characteristic load-carrying capacity $F_{2/3,Rk}$ (N) for one / two angle brackets		
angle bracket	1	2
$F_{2/3,Rk}$	T	1250
	S	-

Characteristic load-carrying capacity $F_{4,Rk}$ (N) for one angle bracket																	
e (mm)	0	20	40	60	80	100	120	140	160	180	200	220	240	260	280	300	320
$F_{4,Rk}$	T	-	-	1125	188	102	70	54	43	36	31	27	24	22	20	18	17
	S	-	74	37	24	18	14	11	9	7	6	5	5	4	4	3	3
k_t (-)	0,0	3,6	7,3	10,9	14,5	18,2	21,8	25,5	29,1	32,7	36,4	40,0	43,6	47,3	50,9	54,5	58,2

Characteristic load-carrying capacity $F_{5,Rk}$ (N) for one angle bracket																	
b / e (mm)	0	20	40	60	80	100	120	140	160	180	200	220	240	260	280	300	320
0	T	125	281	1508	1005	754	603	503	431	377	335	302	274	251	232	215	201
	S	26	60	323	215	161	129	107	92	80	71	64	58	53	49	46	43
20	T	125	281	1508	1005	754	603	503	431	377	335	302	274	251	232	215	201
	S	26	60	323	215	161	129	107	92	80	71	64	58	53	49	46	43
40	T	125	281	1508	1005	754	603	503	431	377	335	302	274	251	232	215	201
	S	26	60	323	215	161	129	107	92	80	71	64	58	53	49	46	43
60	T	125	281	1508	1005	754	603	503	431	377	335	302	274	251	232	215	201
	S	26	60	323	215	161	129	107	92	80	71	64	58	53	49	46	43
80	T	125	281	1508	1005	754	603	503	431	377	335	302	274	251	232	215	201
	S	26	60	323	215	161	129	107	92	80	71	64	58	53	49	46	43
100	T	125	281	1508	1005	754	603	503	431	377	335	302	274	251	232	215	201
	S	26	60	323	215	161	129	107	92	80	71	64	58	53	49	46	43
120	T	125	281	1508	1005	754	603	503	431	377	335	302	274	251	232	215	201
	S	26	60	323	215	161	129	107	92	80	71	64	58	53	49	46	43
140	T	125	281	1508	1005	754	603	503	431	377	335	302	274	251	232	215	201
	S	26	60	323	215	161	129	107	92	80	71	64	58	53	49	46	43
160	T	125	281	1508	1005	754	603	503	431	377	335	302	274	251	232	215	201
	S	26	60	323	215	161	129	107	92	80	71	64	58	53	49	46	43
180	T	125	281	1508	1005	754	603	503	431	377	335	302	274	251	232	215	201
	S	26	60	323	215	161	129	107	92	80	71	64	58	53	49	46	43
200	T	125	281	1508	1005	754	603	503	431	377	335	302	274	251	232	215	201
	S	26	60	323	215	161	129	107	92	80	71	64	58	53	49	46	43
220	T	125	281	1508	1005	754	603	503	431	377	335	302	274	251	232	215	201
	S	26	60	323	215	161	129	107	92	80	71	64	58	53	49	46	43
240	T	125	281	1508	1005	754	603	503	431	377	335	302	274	251	232	215	201
	S	26	60	323	215	161	129	107	92	80	71	64	58	53	49	46	43
$k_x \times b$ (-)	0,0	16,7	33,4	50,1	66,8	83,5	100,2	116,9	133,6	150,3	167,0	183,7	200,3	217,0	233,7	250,4	267,1

Characteristic load-carrying capacity $F_{4/5,Rk}$ (N) for two angle brackets																	
b / e (mm)	0	20	40	60	80	100	120	140	160	180	200	220	240	260	280	300	320
0	T	8999	8999	8999	8999	8999	8999	8999	8999	8999	8999	8999	8999	8999	8999	8999	8999
	S	-	-	-	-	-	-	-	-	-	-	-	-	-	-	-	-
20	T	8999	8200	4100	2733	2050	1640	1367	1171	1025	911	820	745	683	631	586	547
	S	-	28	14	9	7	5	4	4	3	3	2	2	2	2	2	1
40	T	8999	9000	8200	5467	4100	3280	2733	2343	2050	1822	1640	1491	1367	1262	1171	1093
	S	-	56	28	18	14	11	9	8	7	6	5	5	4	4	4	3
60	T	8999	9000	9000	8200	6150	4920	4100	3514	3075	2733	2460	2236	2050	1892	1757	1640
	S	-	84	42	28	21	16	14	12	10	9	8	7	7	6	6	5
80	T	8999	9000	9000	9000	8200	6560	5467	4686	4100	3644	3280	2982	2733	2523	2343	2187
	S	-	112	56	37	28	22	18	16	14	12	11	10	9	8	8	7
100	T	8999	9000	9000	9000	9000	8200	6833	5857	5125	4556	4100	3727	3417	3154	2929	2733
	S	-	141	70	47	35	28	23	20	17	15	14	12	11	10	10	9
120	T	8999	9000	9000	9000	9000	8200	7029	6150	5467	4920	4473	4100	3785	3514	3280	3075
	S	-	169	84	56	42	33	28	24	21	18	16	15	14	13	12	11
140	T	8999	9000	9000	9000	9000	9000	8200	7175	6378	5740	5218	4783	4415	4100	3827	3588
	S	-	197	98	65	49	39	32	28	24	21	19	17	16	15	14	13
160	T	8999	9000	9000	9000	9000	9000	9000	8200	7289	6560	5964	5467	5046	4686	4373	4100
	S	-	225	112	75	56	45	37	32	28	25	22	20	18	17	16	15
180	T	8999	9000	9000	9000	9000	9000	9000	9000	8200	7380	6709	6150	5677	5271	4920	4613
	S	-	254	127	84	63	50	42	36	31	28	25	23	21	19	18	16
200	T	8999	9000	9000	9000	9000	9000	9000	9000	9000	8200	7455	6833	6308	5857	5467	5125
	S	-	282	141	94	70	56	47	40	35	31	28	25	23	21	20	18
220	T	8999	9000	9000	9000	9000	9000	9000	9000	9000	9000	8200	7517	6938	6443	6013	5638
	S	-	310	155	103	77	62	51	44	38	34	31	28	25	23	22	20
240	T	8999	9000	9000	9000	9000	9000	9000	9000	9000	9000	8200	7569	7029	6560	6150	5821
	S	-	338	169	112	84	67	56	48	42	37	33	30	28	26	24	22
$k_x \times b$ (-)	0,0	192,7	385,5	578,2	770,9	963,6	1156,4	1349,1	1541,8	1734,5	1927,3	2120,0	2312,7	2505,5	2698,2	2890,9	3083,6

TTM: Timber-Timber-Maximum | TTP: Timber-Timber-Partial | TCM: Timber-Concrete-Maximum | TCP: Timber-Concrete-Partial

T: $F_{T,Rk}$ load-carrying capacity of timber | S: $F_{S,Rk}$ load-carrying capacity of steel

Table B. 139 Angle bracket type 5502SA4, Variant TCM, Fastener Profiled nail A4 4x60, Density 350 kg/m³Characteristic load-carrying capacity $F_{1,Rk}$ (N) for one / two angle brackets

angle bracket		1													2
f (mm)		0	10	20	30	40	50	60	70	80	90	100	110	120	0
$F_{1,Rk}$	T	9945	750	375	250	188	150	125	107	94	83	75	68	63	19890
	S	28	23	20	18	16	14	13	12	11	10	9	8	8	
$k_t (-)$		9,6	11,5	13,3	15,1	16,9	18,7	20,5	22,4	24,2	26,0	27,8	29,6	31,5	4,8

Characteristic load-carrying capacity $F_{2/3,Rk}$ (N) for one / two angle brackets

angle bracket		1	2
$F_{2/3,Rk}$	T	1880	3760
	S	-	-

Characteristic load-carrying capacity $F_{4,Rk}$ (N) for one angle bracket

e (mm)		0	20	40	60	80	100	120	140	160	180	200	220	240	260	280	300	320
$F_{4,Rk}$	T	-	-	1875	313	170	117	89	72	60	52	46	41	37	33	31	28	26
	S	-	74	37	24	18	14	11	9	7	6	5	5	4	4	3	3	3
$k_t (-)$		0,0	3,6	7,3	10,9	14,5	18,2	21,8	25,5	29,1	32,7	36,4	40,0	43,6	47,3	50,9	54,5	58,2

Characteristic load-carrying capacity $F_{5,Rk}$ (N) for one angle bracket

b / e (mm)		0	20	40	60	80	100	120	140	160	180	200	220	240	260	280	300	320
0	T	208	469	2513	1675	1256	1005	838	718	628	558	503	457	419	387	359	335	314
	S	26	60	323	215	161	129	107	92	80	71	64	58	53	49	46	43	40
20	T	208	469	2513	1675	1256	1005	838	718	628	558	503	457	419	387	359	335	314
	S	26	60	323	215	161	129	107	92	80	71	64	58	53	49	46	43	40
40	T	208	469	2513	1675	1256	1005	838	718	628	558	503	457	419	387	359	335	314
	S	26	60	323	215	161	129	107	92	80	71	64	58	53	49	46	43	40
60	T	208	469	2513	1675	1256	1005	838	718	628	558	503	457	419	387	359	335	314
	S	26	60	323	215	161	129	107	92	80	71	64	58	53	49	46	43	40
80	T	208	469	2513	1675	1256	1005	838	718	628	558	503	457	419	387	359	335	314
	S	26	60	323	215	161	129	107	92	80	71	64	58	53	49	46	43	40
100	T	208	469	2513	1675	1256	1005	838	718	628	558	503	457	419	387	359	335	314
	S	26	60	323	215	161	129	107	92	80	71	64	58	53	49	46	43	40
120	T	208	469	2513	1675	1256	1005	838	718	628	558	503	457	419	387	359	335	314
	S	26	60	323	215	161	129	107	92	80	71	64	58	53	49	46	43	40
140	T	208	469	2513	1675	1256	1005	838	718	628	558	503	457	419	387	359	335	314
	S	26	60	323	215	161	129	107	92	80	71	64	58	53	49	46	43	40
160	T	208	469	2513	1675	1256	1005	838	718	628	558	503	457	419	387	359	335	314
	S	26	60	323	215	161	129	107	92	80	71	64	58	53	49	46	43	40
180	T	208	469	2513	1675	1256	1005	838	718	628	558	503	457	419	387	359	335	314
	S	26	60	323	215	161	129	107	92	80	71	64	58	53	49	46	43	40
200	T	208	469	2513	1675	1256	1005	838	718	628	558	503	457	419	387	359	335	314
	S	26	60	323	215	161	129	107	92	80	71	64	58	53	49	46	43	40
220	T	208	469	2513	1675	1256	1005	838	718	628	558	503	457	419	387	359	335	314
	S	26	60	323	215	161	129	107	92	80	71	64	58	53	49	46	43	40
240	T	208	469	2513	1675	1256	1005	838	718	628	558	503	457	419	387	359	335	314
	S	26	60	323	215	161	129	107	92	80	71	64	58	53	49	46	43	40
$k_x \times b (-)$		0,0	16,7	33,4	50,1	66,8	83,5	100,2	116,9	133,6	150,3	167,0	183,7	200,3	217,0	233,7	250,4	267,1

Characteristic load-carrying capacity $F_{4/5,Rk}$ (N) for two angle brackets

b / e (mm)		0	20	40	60	80	100	120	140	160	180	200	220	240	260	280	300	320
0	T	15000	15000	15000	15000	15000	15000	15000	15000	15000	15000	15000	15000	15000	15000	15000	15000	15000
	S	-	-	-	-	-	-	-	-	-	-	-	-	-	-	-	-	-
20	T	15000	9945	4973	3315	2486	1989	1658	1421	1243	1105	995	904	829	765	710	663	622
	S	-	28	14	9	7	5	4	4	3	3	2	2	2	2	2	1	1
40	T	15000	15000	9945	6630	4973	3978	3315	2841	2486	2210	1989	1808	1658	1530	1421	1326	1243
	S	-	56	28	18	14	11	9	8	7	6	5	5	4	4	4	3	3
60	T	15000	15000	14918	9945	7459	5967	4973	4262	3729	3315	2984	2712	2486	2295	2131	1989	1865
	S	-	84	42	28	21	16	14	12	10	9	8	7	7	6	6	5	5
80	T	15000	15000	15000	13260	9945	7956	6630	5683	4973	4420	3978	3616	3315	3060	2841	2652	2486
	S	-	112	56	37	28	22	18	16	14	12	11	10	9	8	8	7	7
100	T	15000	15000	15000	15000	12431	9945	8288	7104	6216	5525	4973	4520	4144	3825	3552	3315	3108
	S	-	141	70	47	35	28	23	20	17	15	14	12	11	10	10	9	8
120	T	15000	15000	15000	15000	14918	11934	9945	8524	7459	6630	5967	5425	4973	4590	4262	3978	3729
	S	-	169	84	56	42	33	28	24	21	18	16	15	14	13	12	11	10
140	T	15000	15000	15000	15000	15000	13923	11603	9945	8702	7735	6962	6329	5801	5355	4973	4641	4351
	S	-	197	98	65	49	39	32	28	24	21	19	17	16	15	14	13	12
160	T	15000	15000	15000	15000	15000	13260	11366	9945	8840	7956	7233	6630	6120	5683	5304	4973	
	S	-	225	112	75	56	45	37	32	28	25	22	20	18	17	16	15	14
180	T	15000	15000	15000	15000	15000	14918	12786	11188	9945	8951	8137	7459	6885	6393	5967	5594	
	S	-	254	127	84	63	50	42	36	31	28	25	23	21	19	18	16	15
200	T	15000	15000	15000	15000	15000	15000	14207	12431	11050	9945	9041	8288	7650	7104	6630	6216	
	S	-	282	141	94	70	56	47	40	35	31	28	25	23	21	20	18	17
220	T	15000	15000	15000	15000	15000	15000	15000	13674	12155	10940	9945	9116	8415	7814	7293	6837	
	S	-	310	155	103	77	62	51	44	38	34	31	28	25	23	22	20	19
240	T	15000	15000	15000	15000	15000	15000	15000	14918	13260	11934	10849	9945	9180	8524	7956	7459	
	S	-	338	169	112	84	67	56	48	42	37	33	30	28	26	24	22	21
$k_x \times b (-)$		0,0	192,7	385,5	578,2	770,9	963,6	1156,4	1349,1	1541,8	1734,5	1927,3	2120,0	2312,7	2505,5	2698,2	2890,9	3083,6

TTM: Timber-Timber-Maximum | TTP: Timber-Timber-Partial | TCM: Timber-Concrete-Maximum | TCP: Timber-Concrete-Partial

T: $F_{1,T,Rk}$ load-carrying capacity of timber | S: $F_{1,S,Rk}$ load-carrying capacity of steel

Table B. 140 Angle bracket type 5502SA4, Variant TCP, Fastener Profiled nail A4 4x40, Density 350 kg/m³Characteristic load-carrying capacity $F_{1,Rk}$ (N) for one / two angle brackets

angle bracket	1													2	
f (mm)	0	10	20	30	40	50	60	70	80	90	100	110	120	0	
$F_{1,Rk}$	T	3280	450	225	150	113	90	75	64	56	50	45	41	38	6560
	S	28	23	20	18	16	14	13	12	11	10	9	8	8	56
k_t (-)	9,6	11,5	13,3	15,1	16,9	18,7	20,5	22,4	24,2	26,0	27,8	29,6	31,5	4,8	

Characteristic load-carrying capacity $F_{2/3,Rk}$ (N) for one / two angle brackets

angle bracket	1	2	
$F_{2/3,Rk}$	T	430	860
	S	-	-

Characteristic load-carrying capacity $F_{4,Rk}$ (N) for one angle bracket

e (mm)	0	20	40	60	80	100	120	140	160	180	200	220	240	260	280	300	320
$F_{4,Rk}$	T	-	-	1125	188	102	70	54	43	36	31	27	24	22	20	18	16
	S	-	74	37	24	18	14	11	9	7	6	5	5	4	4	3	3
k_t (-)	0,0	3,6	7,3	10,9	14,5	18,2	21,8	25,5	29,1	32,7	36,4	40,0	43,6	47,3	50,9	54,5	58,2

Characteristic load-carrying capacity $F_{5,Rk}$ (N) for one angle bracket

b / e (mm)	0	20	40	60	80	100	120	140	160	180	200	220	240	260	280	300	320
0	T	125	281	1508	1005	754	603	503	431	377	335	302	274	251	232	215	201
	S	26	60	323	215	161	129	107	92	80	71	64	58	53	49	46	43
20	T	125	281	1508	1005	754	603	503	431	377	335	302	274	251	232	215	201
	S	26	60	323	215	161	129	107	92	80	71	64	58	53	49	46	43
40	T	125	281	1508	1005	754	603	503	431	377	335	302	274	251	232	215	201
	S	26	60	323	215	161	129	107	92	80	71	64	58	53	49	46	43
60	T	125	281	1508	1005	754	603	503	431	377	335	302	274	251	232	215	201
	S	26	60	323	215	161	129	107	92	80	71	64	58	53	49	46	43
80	T	125	281	1508	1005	754	603	503	431	377	335	302	274	251	232	215	201
	S	26	60	323	215	161	129	107	92	80	71	64	58	53	49	46	43
100	T	125	281	1508	1005	754	603	503	431	377	335	302	274	251	232	215	201
	S	26	60	323	215	161	129	107	92	80	71	64	58	53	49	46	43
120	T	125	281	1508	1005	754	603	503	431	377	335	302	274	251	232	215	201
	S	26	60	323	215	161	129	107	92	80	71	64	58	53	49	46	43
140	T	125	281	1508	1005	754	603	503	431	377	335	302	274	251	232	215	201
	S	26	60	323	215	161	129	107	92	80	71	64	58	53	49	46	43
160	T	125	281	1508	1005	754	603	503	431	377	335	302	274	251	232	215	201
	S	26	60	323	215	161	129	107	92	80	71	64	58	53	49	46	43
180	T	125	281	1508	1005	754	603	503	431	377	335	302	274	251	232	215	201
	S	26	60	323	215	161	129	107	92	80	71	64	58	53	49	46	43
200	T	125	281	1508	1005	754	603	503	431	377	335	302	274	251	232	215	201
	S	26	60	323	215	161	129	107	92	80	71	64	58	53	49	46	43
220	T	125	281	1508	1005	754	603	503	431	377	335	302	274	251	232	215	201
	S	26	60	323	215	161	129	107	92	80	71	64	58	53	49	46	43
240	T	125	281	1508	1005	754	603	503	431	377	335	302	274	251	232	215	201
	S	26	60	323	215	161	129	107	92	80	71	64	58	53	49	46	43
$k_x \times b$ (-)	0,0	16,7	33,4	50,1	66,8	83,5	100,2	116,9	133,6	150,3	167,0	183,7	200,3	217,0	233,7	250,4	267,1

Characteristic load-carrying capacity $F_{4/5,Rk}$ (N) for two angle brackets

b / e (mm)	0	20	40	60	80	100	120	140	160	180	200	220	240	260	280	300	320
0	T	3600	3600	3600	3600	3600	3600	3600	3600	3600	3600	3600	3600	3600	3600	3600	3600
	S	-	-	-	-	-	-	-	-	-	-	-	-	-	-	-	-
20	T	3600	3280	1640	1093	820	656	547	469	410	364	328	298	273	252	234	219
	S	-	28	14	9	7	5	4	4	3	3	2	2	2	2	2	1
40	T	3600	3600	3280	2187	1640	1312	1093	937	820	729	656	596	547	505	469	437
	S	-	56	28	18	14	11	9	8	7	6	5	5	4	4	3	3
60	T	3600	3600	3600	3280	2460	1968	1640	1406	1230	1093	984	895	820	757	703	656
	S	-	84	42	28	21	16	14	12	10	9	8	7	7	6	6	5
80	T	3600	3600	3600	3600	3280	2624	2187	1874	1640	1458	1312	1193	1093	1009	937	875
	S	-	112	56	37	28	22	18	16	14	12	11	10	9	8	8	7
100	T	3600	3600	3600	3600	3600	3280	2733	2343	2050	1822	1640	1491	1367	1262	1171	1093
	S	-	141	70	47	35	28	23	20	17	15	14	12	11	10	10	9
120	T	3600	3600	3600	3600	3600	3280	2811	2460	2187	1968	1789	1640	1514	1406	1312	1230
	S	-	169	84	56	42	33	28	24	21	18	16	15	14	13	12	11
140	T	3600	3600	3600	3600	3600	3600	3280	2870	2551	2296	2087	1913	1766	1640	1531	1435
	S	-	197	98	65	49	39	32	28	24	21	19	17	16	15	14	13
160	T	3600	3600	3600	3600	3600	3600	3600	3280	2916	2624	2385	2187	2018	1874	1749	1640
	S	-	225	112	75	56	45	37	32	28	25	22	20	18	17	16	15
180	T	3600	3600	3600	3600	3600	3600	3600	3600	3280	2952	2684	2460	2271	2109	1968	1845
	S	-	254	127	84	63	50	42	36	31	28	25	23	21	19	18	16
200	T	3600	3600	3600	3600	3600	3600	3600	3600	3600	3600	3280	2982	2733	2523	2343	2187
	S	-	282	141	94	70	56	47	40	35	31	28	25	23	21	20	18
220	T	3600	3600	3600	3600	3600	3600	3600	3600	3600	3600	3600	3280	3007	2775	2405	2255
	S	-	310	155	103	77	62	51	44	38	34	31	28	25	23	22	20
240	T	3600	3600	3600	3600	3600	3600	3600	3600	3600	3600	3600	3578	3280	3028	2811	2624
	S	-	338	169	112	84	67	56	48	42	37	33	30	28	26	24	22
$k_x \times b$ (-)	0,0	192,7	385,5	578,2	770,9	963,6	1156,4	1349,1	1541,8	1734,5	1927,3	2120,0	2312,7	2505,5	2698,2	2890,9	3083,6

TTM: Timber-Timber-Maximum | TTP: Timber-Timber-Partial | TCM: Timber-Concrete-Maximum | TCP: Timber-Concrete-Partial

T: $F_{1,T,Rk}$ load-carrying capacity of timber | S: $F_{1,S,Rk}$ load-carrying capacity of steel

Table B. 141 Angle bracket type 5502SA4, Variant TCP, Fastener Profiled nail A4 4x60, Density 350 kg/m³Characteristic load-carrying capacity $F_{1,Rk}$ (N) for one / two angle brackets

angle bracket	1													2	
f (mm)	0	10	20	30	40	50	60	70	80	90	100	110	120	0	
$F_{1,Rk}$	T	3978	750	375	250	188	150	125	107	94	83	75	68	63	7956
	S	28	23	20	18	16	14	13	12	11	10	9	8	8	56
k_t (-)	9,6	11,5	13,3	15,1	16,9	18,7	20,5	22,4	24,2	26,0	27,8	29,6	31,5	4,8	

Characteristic load-carrying capacity $F_{2/3,Rk}$ (N) for one / two angle brackets

angle bracket	1	2	
$F_{2/3,Rk}$	T	680	1360
	S	-	-

Characteristic load-carrying capacity $F_{4,Rk}$ (N) for one angle bracket

e (mm)	0	20	40	60	80	100	120	140	160	180	200	220	240	260	280	300	320	
$F_{4,Rk}$	T	-	-	1875	313	170	117	89	72	60	52	46	41	37	33	31	28	26
	S	-	74	37	24	18	14	11	9	7	6	5	5	4	4	3	3	3
k_t (-)	0,0	3,6	7,3	10,9	14,5	18,2	21,8	25,5	29,1	32,7	36,4	40,0	43,6	47,3	50,9	54,5	58,2	

Characteristic load-carrying capacity $F_{5,Rk}$ (N) for one angle bracket

b / e (mm)	0	20	40	60	80	100	120	140	160	180	200	220	240	260	280	300	320	
0	T	208	469	2513	1675	1256	1005	838	718	628	558	503	457	419	387	359	335	314
	S	26	60	323	215	161	129	107	92	80	71	64	58	53	49	46	43	40
20	T	208	469	1989	1326	995	796	663	568	497	442	398	362	332	306	284	265	249
	S	26	60	323	215	161	129	107	92	80	71	64	58	53	49	46	43	40
40	T	208	469	2513	1675	1256	1005	838	718	628	558	503	457	419	387	359	335	314
	S	26	60	323	215	161	129	107	92	80	71	64	58	53	49	46	43	40
60	T	208	469	2513	1675	1256	1005	838	718	628	558	503	457	419	387	359	335	314
	S	26	60	323	215	161	129	107	92	80	71	64	58	53	49	46	43	40
80	T	208	469	2513	1675	1256	1005	838	718	628	558	503	457	419	387	359	335	314
	S	26	60	323	215	161	129	107	92	80	71	64	58	53	49	46	43	40
100	T	208	469	2513	1675	1256	1005	838	718	628	558	503	457	419	387	359	335	314
	S	26	60	323	215	161	129	107	92	80	71	64	58	53	49	46	43	40
120	T	208	469	2513	1675	1256	1005	838	718	628	558	503	457	419	387	359	335	314
	S	26	60	323	215	161	129	107	92	80	71	64	58	53	49	46	43	40
140	T	208	469	2513	1675	1256	1005	838	718	628	558	503	457	419	387	359	335	314
	S	26	60	323	215	161	129	107	92	80	71	64	58	53	49	46	43	40
160	T	208	469	2513	1675	1256	1005	838	718	628	558	503	457	419	387	359	335	314
	S	26	60	323	215	161	129	107	92	80	71	64	58	53	49	46	43	40
180	T	208	469	2513	1675	1256	1005	838	718	628	558	503	457	419	387	359	335	314
	S	26	60	323	215	161	129	107	92	80	71	64	58	53	49	46	43	40
200	T	208	469	2513	1675	1256	1005	838	718	628	558	503	457	419	387	359	335	314
	S	26	60	323	215	161	129	107	92	80	71	64	58	53	49	46	43	40
220	T	208	469	2513	1675	1256	1005	838	718	628	558	503	457	419	387	359	335	314
	S	26	60	323	215	161	129	107	92	80	71	64	58	53	49	46	43	40
240	T	208	469	2513	1675	1256	1005	838	718	628	558	503	457	419	387	359	335	314
	S	26	60	323	215	161	129	107	92	80	71	64	58	53	49	46	43	40
$k_x \times b$ (-)	0,0	16,7	33,4	50,1	66,8	83,5	100,2	116,9	133,6	150,3	167,0	183,7	200,3	217,0	233,7	250,4	267,1	

Characteristic load-carrying capacity $F_{4/5,Rk}$ (N) for two angle brackets

b / e (mm)	0	20	40	60	80	100	120	140	160	180	200	220	240	260	280	300	320	
0	T	5999	5999	5999	5999	5999	5999	5999	5999	5999	5999	5999	5999	5999	5999	5999	5999	
	S	-	-	-	-	-	-	-	-	-	-	-	-	-	-	-	-	
20	T	5999	3978	1989	1326	995	796	663	568	497	442	398	362	332	306	284	265	249
	S	-	28	14	9	7	5	4	4	3	3	2	2	2	2	2	1	1
40	T	5999	6000	3978	2652	1989	1591	1326	1137	995	884	796	723	663	612	568	530	497
	S	-	56	28	18	14	11	9	8	7	6	5	5	4	4	4	3	3
60	T	5999	6000	5967	3978	2984	2387	1989	1705	1492	1326	1193	1085	995	918	852	796	746
	S	-	84	42	28	21	16	14	12	10	9	8	7	7	6	6	5	5
80	T	5999	6000	6000	5304	3978	3182	2652	2273	1989	1768	1591	1447	1326	1224	1137	1061	995
	S	-	112	56	37	28	22	18	16	14	12	11	10	9	8	8	7	7
100	T	5999	6000	6000	6000	4973	3978	3315	2841	2486	2210	1989	1808	1658	1530	1421	1326	1243
	S	-	141	70	47	35	28	23	20	17	15	14	12	11	10	10	9	8
120	T	5999	6000	6000	6000	5967	4774	3978	3410	2984	2652	2387	2170	1989	1836	1705	1591	1492
	S	-	169	84	56	42	33	28	24	21	18	16	15	14	13	12	11	10
140	T	5999	6000	6000	6000	6000	5569	4641	3978	3481	3094	2785	2531	2321	2142	1989	1856	1740
	S	-	197	98	65	49	39	32	28	24	21	19	17	16	15	14	13	12
160	T	5999	6000	6000	6000	6000	5304	4546	3978	3536	3182	2893	2652	2448	2273	2122	1989	
	S	-	225	112	75	56	45	37	32	28	25	22	20	18	17	16	15	14
180	T	5999	6000	6000	6000	6000	5967	5115	4475	3978	3580	3255	2984	2754	2557	2387	2238	
	S	-	254	127	84	63	50	42	36	31	28	25	23	21	19	18	16	15
200	T	5999	6000	6000	6000	6000	6000	5683	4973	4420	3978	3616	3315	3060	2841	2652	2486	
	S	-	282	141	94	70	56	47	40	35	31	28	25	23	21	20	18	17
220	T	5999	6000	6000	6000	6000	6000	6000	5470	4862	4376	3978	3647	3366	3126	2917	2735	
	S	-	310	155	103	77	62	51	44	38	34	31	28	25	23	22	20	19
240	T	5999	6000	6000	6000	6000	6000	6000	5967	5304	4774	4340	3978	3672	3410	3182	2984	
	S	-	338	169	112	84	67	56	48	42	37	33	30	28	26	24	22	21
$k_x \times b$ (-)	0,0	192,7	385,5	578,2	770,9	963,6	1156,4	1349,1	1541,8	1734,5	1927,3	2120,0	2312,7	2505,5	2698,2	2890,9	3083,6	

TTM: Timber-Timber-Maximum | TTP: Timber-Timber-Partial | TCM: Timber-Concrete-Maximum | TCP: Timber-Concrete-Partial

T: $F_{1,T,Rk}$ load-carrying capacity of timber | S: $F_{1,S,Rk}$ load-carrying capacity of steel

Table B. 142 Angle bracket type 5502SA4, Variant TTM, Fastener Profiled nail A4 4x40, Density 350 kg/m³Characteristic load-carrying capacity $F_{1,Rk}$ (N) for one / two angle brackets

angle bracket		1												2	
f (mm)		0	10	20	30	40	50	60	70	80	90	100	110	120	0
$F_{1,Rk}$	T	386	245	180	142	113	90	75	64	56	50	45	41	38	771
	S	123	78	48	32	24	19	16	13	12	10	9	8	8	246

Characteristic load-carrying capacity $F_{2/3,Rk}$ (N) for one / two angle brackets

angle bracket		1	2
$F_{2/3,Rk}$	T	3530	7060
	S	-	-

Characteristic load-carrying capacity $F_{4,Rk}$ (N) for one angle bracket

e (mm)		0	20	40	60	80	100	120	140	160	180	200	220	240	260	280	300	320
$F_{4,Rk}$	T	13120	338	169	113	84	68	54	43	36	31	27	24	22	20	18	17	16
	S	-	107	53	35	21	15	11	9	7	6	5	5	4	4	3	3	3

Characteristic load-carrying capacity $F_{5,Rk}$ (N) for one angle bracket

b / e (mm)		0	20	40	60	80	100	120	140	160	180	200	220	240	260	280	300	320
0	T	125	281	1013	675	506	405	338	289	253	225	203	184	169	156	145	135	127
	S	26	60	323	215	161	129	107	92	80	71	64	58	53	49	46	43	40
20	T	125	281	1508	1005	754	603	503	431	377	335	302	274	251	232	215	201	188
	S	26	60	323	215	161	129	107	92	80	71	64	58	53	49	46	43	40
40	T	125	281	1508	1005	754	603	503	431	377	335	302	274	251	232	215	201	188
	S	26	60	323	215	161	129	107	92	80	71	64	58	53	49	46	43	40
60	T	125	281	1508	1005	754	603	503	431	377	335	302	274	251	232	215	201	188
	S	26	60	323	215	161	129	107	92	80	71	64	58	53	49	46	43	40
80	T	125	281	1508	1005	754	603	503	431	377	335	302	274	251	232	215	201	188
	S	26	60	323	215	161	129	107	92	80	71	64	58	53	49	46	43	40
100	T	125	281	1508	1005	754	603	503	431	377	335	302	274	251	232	215	201	188
	S	26	60	323	215	161	129	107	92	80	71	64	58	53	49	46	43	40
120	T	125	281	1508	1005	754	603	503	431	377	335	302	274	251	232	215	201	188
	S	26	60	323	215	161	129	107	92	80	71	64	58	53	49	46	43	40
140	T	125	281	1508	1005	754	603	503	431	377	335	302	274	251	232	215	201	188
	S	26	60	323	215	161	129	107	92	80	71	64	58	53	49	46	43	40
160	T	125	281	1508	1005	754	603	503	431	377	335	302	274	251	232	215	201	188
	S	26	60	323	215	161	129	107	92	80	71	64	58	53	49	46	43	40
180	T	125	281	1508	1005	754	603	503	431	377	335	302	274	251	232	215	201	188
	S	26	60	323	215	161	129	107	92	80	71	64	58	53	49	46	43	40
200	T	125	281	1508	1005	754	603	503	431	377	335	302	274	251	232	215	201	188
	S	26	60	323	215	161	129	107	92	80	71	64	58	53	49	46	43	40
220	T	125	281	1508	1005	754	603	503	431	377	335	302	274	251	232	215	201	188
	S	26	60	323	215	161	129	107	92	80	71	64	58	53	49	46	43	40
240	T	125	281	1508	1005	754	603	503	431	377	335	302	274	251	232	215	201	188
	S	26	60	323	215	161	129	107	92	80	71	64	58	53	49	46	43	40

Characteristic load-carrying capacity $F_{4/5,Rk}$ (N) for two angle brackets

b / e (mm)		0	20	40	60	80	100	120	140	160	180	200	220	240	260	280	300	320
0	T	8999	8999	8999	8999	8999	8999	8999	8999	8999	8999	8999	8999	8999	8999	8999	8999	8999
	S	-	-	-	-	-	-	-	-	-	-	-	-	-	-	-	-	-
20	T	8999	386	193	129	96	77	64	55	48	43	39	35	32	30	28	26	24
	S	-	123	61	41	30	24	20	17	15	13	12	11	10	9	8	8	7
40	T	8999	771	386	257	193	154	129	110	96	86	77	70	64	59	55	51	48
	S	-	246	123	82	61	49	41	35	30	27	24	22	20	18	17	16	15
60	T	8999	1157	579	386	289	231	193	165	145	129	116	105	96	89	83	77	72
	S	-	369	184	123	92	73	61	52	46	41	36	33	30	28	26	24	23
80	T	8999	1543	771	514	386	309	257	220	193	171	154	140	129	119	110	103	96
	S	-	492	246	164	123	98	82	70	61	54	49	44	41	37	35	32	30
100	T	8999	1929	964	643	482	386	321	276	241	214	193	175	161	148	138	129	121
	S	-	615	307	205	153	123	102	87	76	68	61	55	51	47	43	41	38
120	T	8999	2314	1157	771	579	463	386	331	289	257	231	210	193	178	165	154	145
	S	-	738	369	246	184	147	123	105	92	82	73	67	61	56	52	49	46
140	T	8999	2700	1350	900	675	540	450	386	338	300	270	245	225	208	193	180	169
	S	-	861	430	287	215	172	143	123	107	95	86	78	71	66	61	57	53
160	T	8999	3086	1543	1029	771	617	514	441	386	343	309	281	257	237	220	206	193
	S	-	984	492	328	246	196	164	140	123	109	98	89	82	75	70	65	61
180	T	8999	3471	1736	1157	868	694	579	496	434	386	347	316	289	267	248	231	217
	S	-	1107	553	369	276	221	184	158	138	123	110	100	92	85	79	73	69
200	T	8999	3857	1929	1286	964	771	643	551	482	429	386	351	321	297	276	257	241
	S	-	1230	615	410	307	246	205	175	153	136	123	111	102	94	87	82	76
220	T	8999	4243	2121	1414	1061	849	707	606	530	471	424	386	354	326	303	283	265
	S	-	1354	677	451	338	270	225	193	169	150	135	123	112	104	96	90	84
240	T	8999	4629	2314	1543	1157	926	771	661	579	514	463	421	386	356	331	309	289
	S	-	1477	738	492	369	295	246	211	184	164	147	134	123	113	105	98	92

TTM: Timber-Timber-Maximum | TTP: Timber-Timber-Partial | TCM: Timber-Concrete-Maximum | TCP: Timber-Concrete-Partial

T: $F_{1,T,Rk}$ load-carrying capacity of timber | S: $F_{1,S,Rk}$ load-carrying capacity of steel

Table B. 143 Angle bracket type 5502SA4, Variant TTM, Fastener Profiled nail A4 4x60, Density 350 kg/m³Characteristic load-carrying capacity $F_{1,Rk}$ (N) for one / two angle brackets

angle bracket		1													2
f (mm)		0	10	20	30	40	50	60	70	80	90	100	110	120	0
$F_{1,Rk}$	T	643	409	300	237	188	150	125	107	94	83	75	68	63	1286
	S	123	78	48	32	24	19	16	13	12	10	9	8	8	246

Characteristic load-carrying capacity $F_{2/3,Rk}$ (N) for one / two angle brackets

angle bracket		1	2
$F_{2/3,Rk}$	T	4620	9240
	S	-	-

Characteristic load-carrying capacity $F_{4,Rk}$ (N) for one angle bracket

e (mm)		0	20	40	60	80	100	120	140	160	180	200	220	240	260	280	300	320
$F_{4,Rk}$	T	15912	563	281	188	141	113	89	72	60	52	46	41	37	33	31	28	26
	S	-	107	53	35	21	15	11	9	7	6	5	5	4	4	3	3	3

Characteristic load-carrying capacity $F_{5,Rk}$ (N) for one angle bracket

b / e (mm)		0	20	40	60	80	100	120	140	160	180	200	220	240	260	280	300	320
0	T	208	469	1688	1125	844	675	563	482	422	375	338	307	281	260	241	225	211
	S	26	60	323	215	161	129	107	92	80	71	64	58	53	49	46	43	40
20	T	208	469	2513	1675	1256	1005	838	718	628	558	503	457	419	387	359	335	314
	S	26	60	323	215	161	129	107	92	80	71	64	58	53	49	46	43	40
40	T	208	469	2513	1675	1256	1005	838	718	628	558	503	457	419	387	359	335	314
	S	26	60	323	215	161	129	107	92	80	71	64	58	53	49	46	43	40
60	T	208	469	2513	1675	1256	1005	838	718	628	558	503	457	419	387	359	335	314
	S	26	60	323	215	161	129	107	92	80	71	64	58	53	49	46	43	40
80	T	208	469	2513	1675	1256	1005	838	718	628	558	503	457	419	387	359	335	314
	S	26	60	323	215	161	129	107	92	80	71	64	58	53	49	46	43	40
100	T	208	469	2513	1675	1256	1005	838	718	628	558	503	457	419	387	359	335	314
	S	26	60	323	215	161	129	107	92	80	71	64	58	53	49	46	43	40
120	T	208	469	2513	1675	1256	1005	838	718	628	558	503	457	419	387	359	335	314
	S	26	60	323	215	161	129	107	92	80	71	64	58	53	49	46	43	40
140	T	208	469	2513	1675	1256	1005	838	718	628	558	503	457	419	387	359	335	314
	S	26	60	323	215	161	129	107	92	80	71	64	58	53	49	46	43	40
160	T	208	469	2513	1675	1256	1005	838	718	628	558	503	457	419	387	359	335	314
	S	26	60	323	215	161	129	107	92	80	71	64	58	53	49	46	43	40
180	T	208	469	2513	1675	1256	1005	838	718	628	558	503	457	419	387	359	335	314
	S	26	60	323	215	161	129	107	92	80	71	64	58	53	49	46	43	40
200	T	208	469	2513	1675	1256	1005	838	718	628	558	503	457	419	387	359	335	314
	S	26	60	323	215	161	129	107	92	80	71	64	58	53	49	46	43	40
220	T	208	469	2513	1675	1256	1005	838	718	628	558	503	457	419	387	359	335	314
	S	26	60	323	215	161	129	107	92	80	71	64	58	53	49	46	43	40
240	T	208	469	2513	1675	1256	1005	838	718	628	558	503	457	419	387	359	335	314
	S	26	60	323	215	161	129	107	92	80	71	64	58	53	49	46	43	40

Characteristic load-carrying capacity $F_{4/5,Rk}$ (N) for two angle brackets

b / e (mm)		0	20	40	60	80	100	120	140	160	180	200	220	240	260	280	300	320
0	T	15000	15000	15000	15000	15000	15000	15000	15000	15000	15000	15000	15000	15000	15000	15000	15000	15000
	S	-	-	-	-	-	-	-	-	-	-	-	-	-	-	-	-	-
20	T	15000	643	321	214	161	129	107	92	80	71	64	58	54	49	46	43	40
	S	-	123	61	41	30	24	20	17	15	13	12	11	10	9	8	8	7
40	T	15000	1286	643	429	321	257	214	184	161	143	129	117	107	99	92	86	80
	S	-	246	123	82	61	49	41	35	30	27	24	22	20	18	17	16	15
60	T	15000	1929	964	643	482	386	321	276	241	214	193	175	161	148	138	129	121
	S	-	369	184	123	92	73	61	52	46	41	36	33	30	28	26	24	23
80	T	15000	2571	1286	857	643	514	429	367	321	286	257	234	214	198	184	171	161
	S	-	492	246	164	123	98	82	70	61	54	49	44	41	37	35	32	30
100	T	15000	3214	1607	1071	804	643	536	459	402	357	321	292	268	247	230	214	201
	S	-	615	307	205	153	123	102	87	76	68	61	55	51	47	43	41	38
120	T	15000	3857	1929	1286	964	771	643	551	482	429	386	351	321	297	276	257	241
	S	-	738	369	246	184	147	123	105	92	82	73	67	61	56	52	49	46
140	T	15000	4500	2250	1500	1125	900	750	643	563	500	450	409	375	346	321	300	281
	S	-	861	430	287	215	172	143	123	107	95	86	78	71	66	61	57	53
160	T	15000	5143	2571	1714	1286	1029	857	735	643	571	514	468	429	396	367	343	321
	S	-	984	492	328	246	196	164	140	123	109	98	89	82	75	70	65	61
180	T	15000	5786	2893	1929	1446	1157	964	827	723	643	579	526	482	445	413	386	362
	S	-	1107	553	369	276	221	184	158	138	123	110	100	92	85	79	73	69
200	T	15000	6429	3214	2143	1607	1286	1071	918	804	714	643	584	536	495	459	429	402
	S	-	1230	615	410	307	246	205	175	153	136	123	111	102	94	87	82	76
220	T	15000	7071	3536	2357	1768	1414	1179	1010	884	786	707	643	589	544	505	471	442
	S	-	1354	677	451	338	270	225	193	169	150	135	123	112	104	96	90	84
240	T	15000	7714	3857	2571	1929	1543	1286	1102	964	857	771	701	643	593	551	514	482
	S	-	1477	738	492	369	295	246	211	184	164	147	134	123	113	105	98	92

TTM: Timber-Timber-Maximum | TTP: Timber-Timber-Partial | TCM: Timber-Concrete-Maximum | TCP: Timber-Concrete-Partial

T: $F_{1,T,Rk}$ load-carrying capacity of timber | S: $F_{1,S,Rk}$ load-carrying capacity of steel

Table B. 144 Angle bracket type 5502SA4, Variant TTP, Fastener Profiled nail A4 4x40, Density 350 kg/m³Characteristic load-carrying capacity $F_{1,Rk}$ (N) for one / two angle brackets

angle bracket		1												2	
f (mm)		0	10	20	30	40	50	60	70	80	90	100	110	120	0
$F_{1,Rk}$	T	386	245	180	142	113	90	75	64	56	50	45	41	38	771
	S	123	78	48	32	24	19	16	13	12	10	9	8	8	246

Characteristic load-carrying capacity $F_{2/3,Rk}$ (N) for one / two angle brackets

angle bracket		1	2
$F_{2/3,Rk}$	T	2010	4020
	S	-	-

Characteristic load-carrying capacity $F_{4,Rk}$ (N) for one angle bracket

e (mm)		0	20	40	60	80	100	120	140	160	180	200	220	240	260	280	300	320
$F_{4,Rk}$	T	4920	338	169	113	84	68	54	43	36	31	27	24	22	20	18	17	16
	S	-	107	53	35	21	15	11	9	7	6	5	5	4	4	3	3	3

Characteristic load-carrying capacity $F_{5,Rk}$ (N) for one angle bracket

b / e (mm)		0	20	40	60	80	100	120	140	160	180	200	220	240	260	280	300	320
0	T	125	281	1013	675	506	405	338	289	253	225	203	184	169	156	145	135	127
	S	26	60	323	215	161	129	107	92	80	71	64	58	53	49	46	43	40
20	T	125	281	1508	1005	754	603	503	431	377	335	302	274	251	232	215	201	188
	S	26	60	323	215	161	129	107	92	80	71	64	58	53	49	46	43	40
40	T	125	281	1508	1005	754	603	503	431	377	335	302	274	251	232	215	201	188
	S	26	60	323	215	161	129	107	92	80	71	64	58	53	49	46	43	40
60	T	125	281	1508	1005	754	603	503	431	377	335	302	274	251	232	215	201	188
	S	26	60	323	215	161	129	107	92	80	71	64	58	53	49	46	43	40
80	T	125	281	1508	1005	754	603	503	431	377	335	302	274	251	232	215	201	188
	S	26	60	323	215	161	129	107	92	80	71	64	58	53	49	46	43	40
100	T	125	281	1508	1005	754	603	503	431	377	335	302	274	251	232	215	201	188
	S	26	60	323	215	161	129	107	92	80	71	64	58	53	49	46	43	40
120	T	125	281	1508	1005	754	603	503	431	377	335	302	274	251	232	215	201	188
	S	26	60	323	215	161	129	107	92	80	71	64	58	53	49	46	43	40
140	T	125	281	1508	1005	754	603	503	431	377	335	302	274	251	232	215	201	188
	S	26	60	323	215	161	129	107	92	80	71	64	58	53	49	46	43	40
160	T	125	281	1508	1005	754	603	503	431	377	335	302	274	251	232	215	201	188
	S	26	60	323	215	161	129	107	92	80	71	64	58	53	49	46	43	40
180	T	125	281	1508	1005	754	603	503	431	377	335	302	274	251	232	215	201	188
	S	26	60	323	215	161	129	107	92	80	71	64	58	53	49	46	43	40
200	T	125	281	1508	1005	754	603	503	431	377	335	302	274	251	232	215	201	188
	S	26	60	323	215	161	129	107	92	80	71	64	58	53	49	46	43	40
220	T	125	281	1508	1005	754	603	503	431	377	335	302	274	251	232	215	201	188
	S	26	60	323	215	161	129	107	92	80	71	64	58	53	49	46	43	40
240	T	125	281	1508	1005	754	603	503	431	377	335	302	274	251	232	215	201	188
	S	26	60	323	215	161	129	107	92	80	71	64	58	53	49	46	43	40

Characteristic load-carrying capacity $F_{4/5,Rk}$ (N) for two angle brackets

b / e (mm)		0	20	40	60	80	100	120	140	160	180	200	220	240	260	280	300	320
0	T	3600	3600	3600	3600	3600	3600	3600	3600	3600	3600	3600	3600	3600	3600	3600	3600	3600
	S	-	-	-	-	-	-	-	-	-	-	-	-	-	-	-	-	-
20	T	3600	386	193	129	96	77	64	55	48	43	39	35	32	30	28	26	24
	S	-	123	61	41	30	24	20	17	15	13	12	11	10	9	8	8	7
40	T	3600	771	386	257	193	154	129	110	96	86	77	70	64	59	55	51	48
	S	-	246	123	82	61	49	41	35	30	27	24	22	20	18	17	16	15
60	T	3600	1157	579	386	289	231	193	165	145	129	116	105	96	89	83	77	72
	S	-	369	184	123	92	73	61	52	46	41	36	33	30	28	26	24	23
80	T	3600	1543	771	514	386	309	257	220	193	171	154	140	129	119	110	103	96
	S	-	492	246	164	123	98	82	70	61	54	49	44	41	37	35	32	30
100	T	3600	1929	964	643	482	386	321	276	241	214	193	175	161	148	138	129	121
	S	-	615	307	205	153	123	102	87	76	68	61	55	51	47	43	41	38
120	T	3600	2314	1157	771	579	463	386	331	289	257	231	210	193	178	165	154	145
	S	-	738	369	246	184	147	123	105	92	82	73	67	61	56	52	49	46
140	T	3600	2700	1350	900	675	540	450	386	338	300	270	245	225	208	193	180	169
	S	-	861	430	287	215	172	143	123	107	95	86	78	71	66	61	57	53
160	T	3600	3086	1543	1029	771	617	514	441	386	343	309	281	257	237	220	206	193
	S	-	984	492	328	246	196	164	140	123	109	98	89	82	75	70	65	61
180	T	3600	3471	1736	1157	868	694	579	496	434	386	347	316	289	267	248	231	217
	S	-	1107	553	369	276	221	184	158	138	123	110	100	92	85	79	73	69
200	T	3600	3600	1929	1286	964	771	643	551	482	429	386	351	321	297	276	257	241
	S	-	1230	615	410	307	246	205	175	153	136	123	111	102	94	87	82	76
220	T	3600	3600	2121	1414	1061	849	707	606	530	471	424	386	354	326	303	283	265
	S	-	1354	677	451	338	270	225	193	169	150	135	123	112	104	96	90	84
240	T	3600	3600	2314	1543	1157	926	771	661	579	514	463	421	386	356	331	309	289
	S	-	1477	738	492	369	295	246	211	184	164	147	134	123	113	105	98	92

TTM: Timber-Timber-Maximum | TTP: Timber-Timber-Partial | TCM: Timber-Concrete-Maximum | TCP: Timber-Concrete-Partial

T: $F_{1,T,Rk}$ load-carrying capacity of timber | S: $F_{1,S,Rk}$ load-carrying capacity of steel

Table B. 145 Angle bracket type 5502SA4, Variant TTP, Fastener Profiled nail A4 4x60, Density 350 kg/m³Characteristic load-carrying capacity $F_{T,Rk}$ (N) for one / two angle brackets

angle bracket		1												2	
f (mm)		0	10	20	30	40	50	60	70	80	90	100	110	120	0
$F_{T,Rk}$	T	643	409	300	237	188	150	125	107	94	83	75	68	63	1286
	S	123	78	48	32	24	19	16	13	12	10	9	8	8	246

Characteristic load-carrying capacity $F_{2/3,Rk}$ (N) for one / two angle brackets

angle bracket		1	2
$F_{2/3,Rk}$	T	2700	5400
	S	-	-

Characteristic load-carrying capacity $F_{4,Rk}$ (N) for one angle bracket

e (mm)		0	20	40	60	80	100	120	140	160	180	200	220	240	260	280	300	320
$F_{4,Rk}$	T	5966	563	281	188	141	113	89	72	60	52	46	41	37	33	31	28	26
	S	-	107	53	35	21	15	11	9	7	6	5	5	4	4	3	3	3

Characteristic load-carrying capacity $F_{5,Rk}$ (N) for one angle bracket

b / e (mm)		0	20	40	60	80	100	120	140	160	180	200	220	240	260	280	300	320
0	T	208	469	1688	1125	844	675	563	482	422	375	338	307	281	260	241	225	211
	S	26	60	323	215	161	129	107	92	80	71	64	58	53	49	46	43	40
20	T	208	469	1989	1326	995	796	663	568	497	442	398	362	332	306	284	265	249
	S	26	60	323	215	161	129	107	92	80	71	64	58	53	49	46	43	40
40	T	208	469	2513	1675	1256	1005	838	718	628	558	503	457	419	387	359	335	314
	S	26	60	323	215	161	129	107	92	80	71	64	58	53	49	46	43	40
60	T	208	469	2513	1675	1256	1005	838	718	628	558	503	457	419	387	359	335	314
	S	26	60	323	215	161	129	107	92	80	71	64	58	53	49	46	43	40
80	T	208	469	2513	1675	1256	1005	838	718	628	558	503	457	419	387	359	335	314
	S	26	60	323	215	161	129	107	92	80	71	64	58	53	49	46	43	40
100	T	208	469	2513	1675	1256	1005	838	718	628	558	503	457	419	387	359	335	314
	S	26	60	323	215	161	129	107	92	80	71	64	58	53	49	46	43	40
120	T	208	469	2513	1675	1256	1005	838	718	628	558	503	457	419	387	359	335	314
	S	26	60	323	215	161	129	107	92	80	71	64	58	53	49	46	43	40
140	T	208	469	2513	1675	1256	1005	838	718	628	558	503	457	419	387	359	335	314
	S	26	60	323	215	161	129	107	92	80	71	64	58	53	49	46	43	40
160	T	208	469	2513	1675	1256	1005	838	718	628	558	503	457	419	387	359	335	314
	S	26	60	323	215	161	129	107	92	80	71	64	58	53	49	46	43	40
180	T	208	469	2513	1675	1256	1005	838	718	628	558	503	457	419	387	359	335	314
	S	26	60	323	215	161	129	107	92	80	71	64	58	53	49	46	43	40
200	T	208	469	2513	1675	1256	1005	838	718	628	558	503	457	419	387	359	335	314
	S	26	60	323	215	161	129	107	92	80	71	64	58	53	49	46	43	40
220	T	208	469	2513	1675	1256	1005	838	718	628	558	503	457	419	387	359	335	314
	S	26	60	323	215	161	129	107	92	80	71	64	58	53	49	46	43	40
240	T	208	469	2513	1675	1256	1005	838	718	628	558	503	457	419	387	359	335	314
	S	26	60	323	215	161	129	107	92	80	71	64	58	53	49	46	43	40

Characteristic load-carrying capacity $F_{4/5,Rk}$ (N) for two angle brackets

b / e (mm)		0	20	40	60	80	100	120	140	160	180	200	220	240	260	280	300	320
0	T	5999	5999	5999	5999	5999	5999	5999	5999	5999	5999	5999	5999	5999	5999	5999	5999	5999
	S	-	-	-	-	-	-	-	-	-	-	-	-	-	-	-	-	-
20	T	5999	643	321	214	161	129	107	92	80	71	64	58	54	49	46	43	40
	S	-	123	61	41	30	24	20	17	15	13	12	11	10	9	8	8	7
40	T	5999	1286	643	429	321	257	214	184	161	143	129	117	107	99	92	86	80
	S	-	246	123	82	61	49	41	35	30	27	24	22	20	18	17	16	15
60	T	5999	1929	964	643	482	386	321	276	241	214	193	175	161	148	138	129	121
	S	-	369	184	123	92	73	61	52	46	41	36	33	30	28	26	24	23
80	T	5999	2571	1286	857	643	514	429	367	321	286	257	234	214	198	184	171	161
	S	-	492	246	164	123	98	82	70	61	54	49	44	41	37	35	32	30
100	T	5999	3214	1607	1071	804	643	536	459	402	357	321	292	268	247	230	214	201
	S	-	615	307	205	153	123	102	87	76	68	61	55	51	47	43	41	38
120	T	5999	3857	1929	1286	964	771	643	551	482	429	386	351	321	297	276	257	241
	S	-	738	369	246	184	147	123	105	92	82	73	67	61	56	52	49	46
140	T	5999	4500	2250	1500	1125	900	750	643	563	500	450	409	375	346	321	300	281
	S	-	861	430	287	215	172	143	123	107	95	86	78	71	66	61	57	53
160	T	5999	5143	2571	1714	1286	1029	857	735	643	571	514	468	429	396	367	343	321
	S	-	984	492	328	246	196	164	140	123	109	98	89	82	75	70	65	61
180	T	5999	5786	2893	1929	1446	1157	964	827	723	643	579	526	482	445	413	386	362
	S	-	1107	553	369	276	221	184	158	138	123	110	100	92	85	79	73	69
200	T	5999	6000	3214	2143	1607	1286	1071	918	804	714	643	584	536	495	459	429	402
	S	-	1230	615	410	307	246	205	175	153	136	123	111	102	94	87	82	76
220	T	5999	6000	3536	2357	1768	1414	1179	1010	884	786	707	643	589	544	505	471	442
	S	-	1354	677	451	338	270	225	193	169	150	135	123	112	104	96	90	84
240	T	5999	6000	3857	2571	1929	1543	1286	1102	964	857	771	701	643	593	551	514	482
	S	-	1477	738	492	369	295	246	211	184	164	147	134	123	113	105	98	92

TTM: Timber-Timber-Maximum | TTP: Timber-Timber-Partial | TCM: Timber-Concrete-Maximum | TCP: Timber-Concrete-Partial

T: $F_{T,Rk}$ load-carrying capacity of timber | S: $F_{S,Rk}$ load-carrying capacity of steel

Table B. 146 Angle bracket type 6503SA4, Variant TCM, Fastener Profiled nail A4 4x40, Density 350 kg/m³Characteristic load-carrying capacity $F_{1,Rk}$ (N) for one / two angle brackets

angle bracket		1													2
f (mm)		0	10	20	30	40	50	60	70	80	90	100	110	120	0
$F_{1,Rk}$	T	13120	4886	2443	1629	1221	977	814	698	611	543	489	444	407	26240
	S	21	19	17	15	14	13	12	11	10	10	9	9	8	42
k_t (-)		14,6	16,5	18,3	20,1	21,9	23,7	25,5	27,4	29,2	31,0	32,8	34,6	36,5	7,3

Characteristic load-carrying capacity $F_{2/3,Rk}$ (N) for one / two angle brackets

angle bracket		1	2
$F_{2/3,Rk}$	T	1710	3420
	S	-	-

Characteristic load-carrying capacity $F_{4,Rk}$ (N) for one angle bracket

e (mm)		0	20	40	60	80	100	120	140	160	180	200	220	240	260	280	300	320
$F_{4,Rk}$	T	-	-	-	13959	2079	1123	769	585	472	396	340	299	266	240	219	201	185
	S	-	88	44	29	22	17	14	12	11	9	8	8	7	6	6	5	5
k_t (-)		0,0	3,6	7,3	10,9	14,5	18,2	21,8	25,5	29,1	32,7	36,4	40,0	43,6	47,3	50,9	54,5	58,2

Characteristic load-carrying capacity $F_{5,Rk}$ (N) for one angle bracket

b / e (mm)		0	20	40	60	80	100	120	140	160	180	200	220	240	260	280	300	320
0	T	865	1339	2961	2194	1645	1316	1097	940	823	731	658	598	548	506	470	439	411
	S	165	256	566	400	300	240	200	171	150	133	120	109	100	92	85	80	75
20	T	865	1339	2961	2194	1645	1316	1097	940	823	731	658	598	548	506	470	439	411
	S	165	256	566	400	300	240	200	171	150	133	120	109	100	92	85	80	75
40	T	865	1339	2961	2194	1645	1316	1097	940	823	731	658	598	548	506	470	439	411
	S	165	256	566	400	300	240	200	171	150	133	120	109	100	92	85	80	75
60	T	865	1339	2961	2194	1645	1316	1097	940	823	731	658	598	548	506	470	439	411
	S	165	256	566	400	300	240	200	171	150	133	120	109	100	92	85	80	75
80	T	865	1339	2961	2194	1645	1316	1097	940	823	731	658	598	548	506	470	439	411
	S	165	256	566	400	300	240	200	171	150	133	120	109	100	92	85	80	75
100	T	865	1339	2961	2194	1645	1316	1097	940	823	731	658	598	548	506	470	439	411
	S	165	256	566	400	300	240	200	171	150	133	120	109	100	92	85	80	75
120	T	865	1339	2961	2194	1645	1316	1097	940	823	731	658	598	548	506	470	439	411
	S	165	256	566	400	300	240	200	171	150	133	120	109	100	92	85	80	75
140	T	865	1339	2961	2194	1645	1316	1097	940	823	731	658	598	548	506	470	439	411
	S	165	256	566	400	300	240	200	171	150	133	120	109	100	92	85	80	75
160	T	865	1339	2961	2194	1645	1316	1097	940	823	731	658	598	548	506	470	439	411
	S	165	256	566	400	300	240	200	171	150	133	120	109	100	92	85	80	75
180	T	865	1339	2961	2194	1645	1316	1097	940	823	731	658	598	548	506	470	439	411
	S	165	256	566	400	300	240	200	171	150	133	120	109	100	92	85	80	75
200	T	865	1339	2961	2194	1645	1316	1097	940	823	731	658	598	548	506	470	439	411
	S	165	256	566	400	300	240	200	171	150	133	120	109	100	92	85	80	75
220	T	865	1339	2961	2194	1645	1316	1097	940	823	731	658	598	548	506	470	439	411
	S	165	256	566	400	300	240	200	171	150	133	120	109	100	92	85	80	75
240	T	865	1339	2961	2194	1645	1316	1097	940	823	731	658	598	548	506	470	439	411
	S	165	256	566	400	300	240	200	171	150	133	120	109	100	92	85	80	75
$k_t \times b$ (-)		0,0	15,2	30,5	45,7	61,0	76,2	91,4	106,7	121,9	137,1	152,4	167,6	182,9	198,1	213,3	228,6	243,8

Characteristic load-carrying capacity $F_{4/5,Rk}$ (N) for two angle brackets

b / e (mm)		0	20	40	60	80	100	120	140	160	180	200	220	240	260	280	300	320
0	T	14400	14400	14400	14400	14400	14400	14400	14400	14400	14400	14400	14400	14400	14400	14400	14400	14400
	S	-	-	-	-	-	-	-	-	-	-	-	-	-	-	-	-	-
20	T	14400	13120	6560	4373	3280	2624	2187	1874	1640	1458	1312	1193	1093	1009	937	875	820
	S	-	21	10	7	5	4	3	3	2	2	2	1	1	1	1	1	1
40	T	14400	14400	13120	8747	6560	5248	4373	3749	3280	2916	2624	2385	2187	2018	1874	1749	1640
	S	-	43	21	14	10	8	7	6	5	4	4	3	3	3	3	2	2
60	T	14400	14400	14400	13120	9840	7872	6560	5623	4920	4373	3936	3578	3280	3028	2811	2624	2460
	S	-	65	32	21	16	13	10	9	8	7	6	5	5	4	4	4	4
80	T	14400	14400	14400	14400	13120	10496	8747	7497	6560	5831	5248	4771	4373	4037	3749	3499	3280
	S	-	87	43	29	21	17	14	12	10	9	8	7	7	6	6	5	5
100	T	14400	14400	14400	14400	13120	10933	9371	8200	7289	6560	5964	5467	5046	4686	4373	4100	3880
	S	-	109	54	36	27	21	18	15	13	12	10	9	8	7	7	6	6
120	T	14400	14400	14400	14400	14400	13120	11246	9840	8747	7872	7156	6560	6055	5623	5248	4920	4600
	S	-	131	65	43	32	26	21	18	16	14	13	11	10	10	9	8	8
140	T	14400	14400	14400	14400	14400	14400	13120	11480	10204	9184	8349	7653	7065	6560	6123	5740	5420
	S	-	153	76	51	38	30	25	21	19	17	15	13	12	11	10	10	9
160	T	14400	14400	14400	14400	14400	14400	14400	13120	11662	10496	9542	8747	8074	7497	6997	6560	6240
	S	-	174	87	58	43	34	29	24	21	19	17	15	14	13	12	11	10
180	T	14400	14400	14400	14400	14400	14400	14400	14400	13120	11808	10735	9840	9083	8434	7872	7380	7060
	S	-	196	98	65	49	39	32	28	24	21	19	17	16	15	14	13	12
200	T	14400	14400	14400	14400	14400	14400	14400	14400	14400	13120	11927	10933	10092	9371	8747	8200	7880
	S	-	218	109	72	54	43	36	31	27	24	21	19	18	16	15	14	13
220	T	14400	14400	14400	14400	14400	14400	14400	14400	14400	14400	14400	13120	12027	11102	10309	9621	9020
	S	-	240	120	80	60	48	40	34	30	26	24	21	20	18	17	16	15
240	T	14400	14400	14400	14400	14400	14400	14400	14400	14400	14400	14400	14400	14313	13120	12111	11246	10496
	S	-	262	131	87	65	52	43	37	32	29	26	23	21	20	18	17	16
$k_t \times b$ (-)		0,0	292,7	585,5	878,2	1170,9	1463,6	1756,4	2049,1	2341,8	2634,5	2927,3	3220,0	3512,7	3805,5	4098,2	4390,9	4683,6

TTM: Timber-Timber-Maximum | TTP: Timber-Timber-Partial | TCM: Timber-Concrete-Maximum | TCP: Timber-Concrete-Partial

T: $F_{1,T,Rk}$ load-carrying capacity of timber | S: $F_{1,S,Rk}$ load-carrying capacity of steel

Table B. 147 Angle bracket type 6503SA4, Variant TCM, Fastener Profiled nail A4 4x60, Density 350 kg/m³Characteristic load-carrying capacity $F_{1,Rk}$ (N) for one / two angle brackets

angle bracket		1													2
f (mm)		0	10	20	30	40	50	60	70	80	90	100	110	120	0
$F_{1,Rk}$	T	15912	8143	4071	2714	2036	1629	1357	1163	1018	905	814	740	679	31824
	S	21	19	17	15	14	13	12	11	10	10	9	9	8	42
k_1 (-)		14,6	16,5	18,3	20,1	21,9	23,7	25,5	27,4	29,2	31,0	32,8	34,6	36,5	7,3

Characteristic load-carrying capacity $F_{2/3,Rk}$ (N) for one / two angle brackets

angle bracket		1	2
$F_{2/3,Rk}$	T	2620	5240
	S	-	-

Characteristic load-carrying capacity $F_{4,Rk}$ (N) for one angle bracket

e (mm)		0	20	40	60	80	100	120	140	160	180	200	220	240	260	280	300	320
$F_{4,Rk}$	T	-	-	-	23265	3465	1872	1282	975	787	659	567	498	444	400	364	334	309
	S	-	88	44	29	22	17	14	12	11	9	8	8	7	6	6	5	5
k_1 (-)		0,0	3,6	7,3	10,9	14,5	18,2	21,8	25,5	29,1	32,7	36,4	40,0	43,6	47,3	50,9	54,5	58,2

Characteristic load-carrying capacity $F_{5,Rk}$ (N) for one angle bracket

b / e (mm)		0	20	40	60	80	100	120	140	160	180	200	220	240	260	280	300	320
0	T	1441	2231	4935	3656	2742	2194	1828	1567	1371	1219	1097	997	914	844	783	731	686
	S	165	256	566	400	300	240	200	171	150	133	120	109	100	92	85	80	75
20	T	1441	2231	4935	3656	2742	2194	1828	1567	1371	1219	1097	997	914	844	783	731	686
	S	165	256	566	400	300	240	200	171	150	133	120	109	100	92	85	80	75
40	T	1441	2231	4935	3656	2742	2194	1828	1567	1371	1219	1097	997	914	844	783	731	686
	S	165	256	566	400	300	240	200	171	150	133	120	109	100	92	85	80	75
60	T	1441	2231	4935	3656	2742	2194	1828	1567	1371	1219	1097	997	914	844	783	731	686
	S	165	256	566	400	300	240	200	171	150	133	120	109	100	92	85	80	75
80	T	1441	2231	4935	3656	2742	2194	1828	1567	1371	1219	1097	997	914	844	783	731	686
	S	165	256	566	400	300	240	200	171	150	133	120	109	100	92	85	80	75
100	T	1441	2231	4935	3656	2742	2194	1828	1567	1371	1219	1097	997	914	844	783	731	686
	S	165	256	566	400	300	240	200	171	150	133	120	109	100	92	85	80	75
120	T	1441	2231	4935	3656	2742	2194	1828	1567	1371	1219	1097	997	914	844	783	731	686
	S	165	256	566	400	300	240	200	171	150	133	120	109	100	92	85	80	75
140	T	1441	2231	4935	3656	2742	2194	1828	1567	1371	1219	1097	997	914	844	783	731	686
	S	165	256	566	400	300	240	200	171	150	133	120	109	100	92	85	80	75
160	T	1441	2231	4935	3656	2742	2194	1828	1567	1371	1219	1097	997	914	844	783	731	686
	S	165	256	566	400	300	240	200	171	150	133	120	109	100	92	85	80	75
180	T	1441	2231	4935	3656	2742	2194	1828	1567	1371	1219	1097	997	914	844	783	731	686
	S	165	256	566	400	300	240	200	171	150	133	120	109	100	92	85	80	75
200	T	1441	2231	4935	3656	2742	2194	1828	1567	1371	1219	1097	997	914	844	783	731	686
	S	165	256	566	400	300	240	200	171	150	133	120	109	100	92	85	80	75
220	T	1441	2231	4935	3656	2742	2194	1828	1567	1371	1219	1097	997	914	844	783	731	686
	S	165	256	566	400	300	240	200	171	150	133	120	109	100	92	85	80	75
240	T	1441	2231	4935	3656	2742	2194	1828	1567	1371	1219	1097	997	914	844	783	731	686
	S	165	256	566	400	300	240	200	171	150	133	120	109	100	92	85	80	75
$k_1 \times b$ (-)		0,0	15,2	30,5	45,7	61,0	76,2	91,4	106,7	121,9	137,1	152,4	167,6	182,9	198,1	213,3	228,6	243,8

Characteristic load-carrying capacity $F_{4/5,Rk}$ (N) for two angle brackets

b / e (mm)		0	20	40	60	80	100	120	140	160	180	200	220	240	260	280	300	320
0	T	23999	23999	23999	23999	23999	23999	23999	23999	23999	23999	23999	23999	23999	23999	23999	23999	23999
	S	-	-	-	-	-	-	-	-	-	-	-	-	-	-	-	-	-
20	T	23999	15912	7956	5304	3978	3182	2652	2273	1989	1768	1591	1447	1326	1224	1137	1061	995
	S	-	21	10	7	5	4	3	3	2	2	2	1	1	1	1	1	1
40	T	23999	24000	15912	10608	7956	6365	5304	4546	3978	3536	3182	2893	2652	2448	2273	2122	1989
	S	-	43	21	14	10	8	7	6	5	4	4	3	3	3	3	2	2
60	T	23999	24000	23868	15912	11934	9547	7956	6819	5967	5304	4774	4340	3978	3672	3410	3182	2984
	S	-	65	32	21	16	13	10	9	8	7	6	5	5	5	4	4	4
80	T	23999	24000	24000	21216	15912	12730	10608	9093	7956	7072	6365	5786	5304	4896	4546	4243	3978
	S	-	87	43	29	21	17	14	12	10	9	8	7	7	6	6	5	5
100	T	23999	24000	24000	24000	19890	15912	13260	11366	9945	8840	7956	7233	6630	6120	5683	5304	4973
	S	-	109	54	36	27	21	18	15	13	12	10	9	9	8	7	7	6
120	T	23999	24000	24000	24000	23868	19094	15912	13639	11934	10608	9547	8679	7956	7344	6819	6365	5967
	S	-	131	65	43	32	26	21	18	16	14	13	11	10	10	9	8	8
140	T	23999	24000	24000	24000	24000	22277	18564	15912	13923	12376	11138	10126	9282	8568	7956	7426	6962
	S	-	153	76	51	38	30	25	21	19	17	15	13	12	11	10	10	9
160	T	23999	24000	24000	24000	24000	21216	18185	15912	14144	12730	11572	10608	9792	9093	8486	7956	
	S	-	174	87	58	43	34	29	24	21	19	17	15	14	13	12	11	10
180	T	23999	24000	24000	24000	24000	23868	20458	17901	15912	14321	13019	11934	11016	10229	9547	8951	
	S	-	196	98	65	49	39	32	28	24	21	19	17	16	15	14	13	12
200	T	23999	24000	24000	24000	24000	24000	22731	19890	17680	15912	14465	13260	12240	11366	10608	9945	
	S	-	218	109	72	54	43	36	31	27	24	21	19	18	16	15	14	13
220	T	23999	24000	24000	24000	24000	24000	24000	21879	19448	17503	15912	14586	13464	12502	11669	10940	
	S	-	240	120	80	60	48	40	34	30	26	24	21	20	18	17	16	15
240	T	23999	24000	24000	24000	24000	24000	24000	23868	21216	19094	17359	15912	14688	13639	12730	11934	
	S	-	262	131	87	65	52	43	37	32	29	26	23	21	20	18	17	16
$k_1 \times b$ (-)		0,0	292,7	585,5	878,2	1170,9	1463,6	1756,4	2049,1	2341,8	2634,5	2927,3	3220,0	3512,7	3805,5	4098,2	4390,9	4683,6

TTM: Timber-Timber-Maximum | TTP: Timber-Timber-Partial | TCM: Timber-Concrete-Maximum | TCP: Timber-Concrete-Partial

T: $F_{1,T,Rk}$ load-carrying capacity of timber | S: $F_{1,S,Rk}$ load-carrying capacity of steel

Table B. 148 Angle bracket type 6503SA4, Variant TCP, Fastener Profiled nail A4 4x40, Density 350 kg/m³Characteristic load-carrying capacity $F_{1,Rk}$ (N) for one / two angle brackets

angle bracket	1													2	
f (mm)	0	10	20	30	40	50	60	70	80	90	100	110	120	0	
$F_{1,Rk}$	T	6560	4050	2025	1350	1013	810	675	579	506	450	405	368	338	13120
	S	21	19	17	15	14	13	12	11	10	9	9	8	8	42
k_1 (-)	14,6	16,5	18,3	20,1	21,9	23,7	25,5	27,4	29,2	31,0	32,8	34,6	36,5	7,3	

Characteristic load-carrying capacity $F_{2/3,Rk}$ (N) for one / two angle brackets

angle bracket	1	2	
$F_{2/3,Rk}$	T	900	1800
	S	-	-

Characteristic load-carrying capacity $F_{4,Rk}$ (N) for one angle bracket

e (mm)	0	20	40	60	80	100	120	140	160	180	200	220	240	260	280	300	320	
$F_{4,Rk}$	T	-	-	-	11571	1723	931	638	485	391	328	282	248	221	199	181	166	154
	S	-	88	44	29	22	17	14	12	11	9	8	8	7	6	6	5	5
k_1 (-)	0,0	3,6	7,3	10,9	14,5	18,2	21,8	25,5	29,1	32,7	36,4	40,0	43,6	47,3	50,9	54,5	58,2	

Characteristic load-carrying capacity $F_{5,Rk}$ (N) for one angle bracket

b / e (mm)	0	20	40	60	80	100	120	140	160	180	200	220	240	260	280	300	320	
0	T	717	1110	2455	1020	765	612	510	437	383	340	306	278	255	235	219	204	191
	S	281	435	600	400	300	240	200	171	150	133	120	109	100	92	85	80	75
20	T	717	1110	2455	1020	765	612	510	437	383	340	306	278	255	235	219	204	191
	S	281	435	600	400	300	240	200	171	150	133	120	109	100	92	85	80	75
40	T	717	1110	2455	1020	765	612	510	437	383	340	306	278	255	235	219	204	191
	S	281	435	600	400	300	240	200	171	150	133	120	109	100	92	85	80	75
60	T	717	1110	2455	1020	765	612	510	437	383	340	306	278	255	235	219	204	191
	S	281	435	600	400	300	240	200	171	150	133	120	109	100	92	85	80	75
80	T	717	1110	2455	1020	765	612	510	437	383	340	306	278	255	235	219	204	191
	S	281	435	600	400	300	240	200	171	150	133	120	109	100	92	85	80	75
100	T	717	1110	2455	1020	765	612	510	437	383	340	306	278	255	235	219	204	191
	S	281	435	600	400	300	240	200	171	150	133	120	109	100	92	85	80	75
120	T	717	1110	2455	1020	765	612	510	437	383	340	306	278	255	235	219	204	191
	S	281	435	600	400	300	240	200	171	150	133	120	109	100	92	85	80	75
140	T	717	1110	2455	1020	765	612	510	437	383	340	306	278	255	235	219	204	191
	S	281	435	600	400	300	240	200	171	150	133	120	109	100	92	85	80	75
160	T	717	1110	2455	1020	765	612	510	437	383	340	306	278	255	235	219	204	191
	S	281	435	600	400	300	240	200	171	150	133	120	109	100	92	85	80	75
180	T	717	1110	2455	1020	765	612	510	437	383	340	306	278	255	235	219	204	191
	S	281	435	600	400	300	240	200	171	150	133	120	109	100	92	85	80	75
200	T	717	1110	2455	1020	765	612	510	437	383	340	306	278	255	235	219	204	191
	S	281	435	600	400	300	240	200	171	150	133	120	109	100	92	85	80	75
220	T	717	1110	2455	1020	765	612	510	437	383	340	306	278	255	235	219	204	191
	S	281	435	600	400	300	240	200	171	150	133	120	109	100	92	85	80	75
240	T	717	1110	2455	1020	765	612	510	437	383	340	306	278	255	235	219	204	191
	S	281	435	600	400	300	240	200	171	150	133	120	109	100	92	85	80	75
$k_1 \times b$ (-)	0,0	15,2	30,5	45,7	61,0	76,2	91,4	106,7	121,9	137,1	152,4	167,6	182,9	198,1	213,3	228,6	243,8	

Characteristic load-carrying capacity $F_{4/5,Rk}$ (N) for two angle brackets

b / e (mm)	0	20	40	60	80	100	120	140	160	180	200	220	240	260	280	300	320	
0	T	7199	7199	7199	7199	7199	7199	7199	7199	7199	7199	7199	7199	7199	7199	7199	7199	
	S	-	-	-	-	-	-	-	-	-	-	-	-	-	-	-	-	
20	T	7199	6560	3280	2187	1640	1312	1093	937	820	729	656	596	547	505	469	437	410
	S	-	21	10	7	5	4	3	3	2	2	2	1	1	1	1	1	1
40	T	7199	7200	6560	4373	3280	2624	2187	1874	1640	1458	1312	1193	1093	1009	937	875	820
	S	-	43	21	14	10	8	7	6	5	4	4	3	3	3	3	2	2
60	T	7199	7200	7200	6560	4920	3936	3280	2811	2460	2187	1968	1789	1640	1514	1406	1312	1230
	S	-	65	32	21	16	13	10	9	8	7	6	5	5	4	4	4	4
80	T	7199	7200	7200	7200	6560	5248	4373	3749	3280	2916	2624	2385	2187	2018	1874	1749	1640
	S	-	87	43	29	21	17	14	12	10	9	8	7	7	6	6	5	5
100	T	7199	7200	7200	7200	6560	5467	4686	4100	3644	3280	2982	2733	2523	2343	2187	2050	
	S	-	109	54	36	27	21	18	15	13	12	10	9	9	8	7	7	6
120	T	7199	7200	7200	7200	7200	6560	5623	4920	4373	3936	3578	3280	3028	2811	2624	2460	
	S	-	131	65	43	32	26	21	18	16	14	13	11	10	10	9	8	8
140	T	7199	7200	7200	7200	7200	7200	6560	5740	5102	4592	4175	3827	3532	3280	3061	2870	
	S	-	153	76	51	38	30	25	21	19	17	15	13	12	11	10	10	9
160	T	7199	7200	7200	7200	7200	7200	7200	6560	5831	5248	4771	4373	4037	3749	3499	3280	
	S	-	174	87	58	43	34	29	24	21	19	17	15	14	13	12	11	10
180	T	7199	7200	7200	7200	7200	7200	7200	7200	6560	5904	5367	4920	4542	4217	3936	3690	
	S	-	196	98	65	49	39	32	28	24	21	19	17	16	15	14	13	12
200	T	7199	7200	7200	7200	7200	7200	7200	7200	7200	6560	5964	5467	5046	4686	4373	4100	
	S	-	218	109	72	54	43	36	31	27	24	21	19	18	16	15	14	13
220	T	7199	7200	7200	7200	7200	7200	7200	7200	7200	7200	6560	6013	5551	5154	4811	4510	
	S	-	240	120	80	60	48	40	34	30	26	24	21	20	18	17	16	15
240	T	7199	7200	7200	7200	7200	7200	7200	7200	7200	7200	7200	7156	6560	6055	5623	5248	4920
	S	-	262	131	87	65	52	43	37	32	29	26	23	21	20	18	17	16
$k_1 \times b$ (-)	0,0	292,7	585,5	878,2	1170,9	1463,6	1756,4	2049,1	2341,8	2634,5	2927,3	3220,0	3512,7	3805,5	4098,2	4390,9	4683,6	

TTM: Timber-Timber-Maximum | TTP: Timber-Timber-Partial | TCM: Timber-Concrete-Maximum | TCP: Timber-Concrete-Partial

T: $F_{1,T,Rk}$ load-carrying capacity of timber | S: $F_{1,S,Rk}$ load-carrying capacity of steel

Table B. 149 Angle bracket type 6503SA4, Variant TCP, Fastener Profiled nail A4 4x60, Density 350 kg/m³

Characteristic load-carrying capacity $F_{1,Rk}$ (N) for one / two angle brackets																		
angle bracket	1														2			
f (mm)	0	10	20	30	40	50	60	70	80	90	100	110	120	0				
$F_{1,Rk}$	T	7956	6750	3375	2250	1688	1350	1125	964	844	750	675	614	563	15912			
	S	21	19	17	15	14	13	12	11	10	10	9	9	8	42			
k_1 (-)	14,6	16,5	18,3	20,1	21,9	23,7	25,5	27,4	29,2	31,0	32,8	34,6	36,5	7,3				
Characteristic load-carrying capacity $F_{2/3,Rk}$ (N) for one / two angle brackets																		
angle bracket	1	2																
$F_{2/3,Rk}$	T	1410	2820															
	S	-	-															
Characteristic load-carrying capacity $F_{4,Rk}$ (N) for one angle bracket																		
e (mm)	0	20	40	60	80	100	120	140	160	180	200	220	240	260	280	300	320	
$F_{4,Rk}$	T	-	-	-	19286	2872	1552	1063	808	652	547	470	413	368	332	302	277	256
	S	-	88	44	29	22	17	14	12	11	9	8	8	7	6	6	5	5
k_1 (-)	0,0	3,6	7,3	10,9	14,5	18,2	21,8	25,5	29,1	32,7	36,4	40,0	43,6	47,3	50,9	54,5	58,2	
Characteristic load-carrying capacity $F_{5,Rk}$ (N) for one angle bracket																		
b / e (mm)	0	20	40	60	80	100	120	140	160	180	200	220	240	260	280	300	320	
0	T	1195	1849	4091	1700	1275	1020	850	729	638	567	510	464	425	392	364	340	319
	S	281	435	600	400	300	240	200	171	150	133	120	109	100	92	85	80	75
20	T	1195	1849	4091	1700	1275	1020	850	729	638	567	510	464	425	392	364	340	319
	S	281	435	600	400	300	240	200	171	150	133	120	109	100	92	85	80	75
40	T	1195	1849	4091	1700	1275	1020	850	729	638	567	510	464	425	392	364	340	319
	S	281	435	600	400	300	240	200	171	150	133	120	109	100	92	85	80	75
60	T	1195	1849	4091	1700	1275	1020	850	729	638	567	510	464	425	392	364	340	319
	S	281	435	600	400	300	240	200	171	150	133	120	109	100	92	85	80	75
80	T	1195	1849	4091	1700	1275	1020	850	729	638	567	510	464	425	392	364	340	319
	S	281	435	600	400	300	240	200	171	150	133	120	109	100	92	85	80	75
100	T	1195	1849	4091	1700	1275	1020	850	729	638	567	510	464	425	392	364	340	319
	S	281	435	600	400	300	240	200	171	150	133	120	109	100	92	85	80	75
120	T	1195	1849	4091	1700	1275	1020	850	729	638	567	510	464	425	392	364	340	319
	S	281	435	600	400	300	240	200	171	150	133	120	109	100	92	85	80	75
140	T	1195	1849	4091	1700	1275	1020	850	729	638	567	510	464	425	392	364	340	319
	S	281	435	600	400	300	240	200	171	150	133	120	109	100	92	85	80	75
160	T	1195	1849	4091	1700	1275	1020	850	729	638	567	510	464	425	392	364	340	319
	S	281	435	600	400	300	240	200	171	150	133	120	109	100	92	85	80	75
180	T	1195	1849	4091	1700	1275	1020	850	729	638	567	510	464	425	392	364	340	319
	S	281	435	600	400	300	240	200	171	150	133	120	109	100	92	85	80	75
200	T	1195	1849	4091	1700	1275	1020	850	729	638	567	510	464	425	392	364	340	319
	S	281	435	600	400	300	240	200	171	150	133	120	109	100	92	85	80	75
220	T	1195	1849	4091	1700	1275	1020	850	729	638	567	510	464	425	392	364	340	319
	S	281	435	600	400	300	240	200	171	150	133	120	109	100	92	85	80	75
240	T	1195	1849	4091	1700	1275	1020	850	729	638	567	510	464	425	392	364	340	319
	S	281	435	600	400	300	240	200	171	150	133	120	109	100	92	85	80	75
$k_1 \times b$ (-)	0,0	15,2	30,5	45,7	61,0	76,2	91,4	106,7	121,9	137,1	152,4	167,6	182,9	198,1	213,3	228,6	243,8	
Characteristic load-carrying capacity $F_{4/5,Rk}$ (N) for two angle brackets																		
b / e (mm)	0	20	40	60	80	100	120	140	160	180	200	220	240	260	280	300	320	
0	T	12000	12000	12000	12000	12000	12000	12000	12000	12000	12000	12000	12000	12000	12000	12000	12000	
	S	-	-	-	-	-	-	-	-	-	-	-	-	-	-	-	-	
20	T	12000	7956	3978	2652	1989	1591	1326	1137	995	884	796	723	663	612	568	530	497
	S	-	21	10	7	5	4	3	3	2	2	2	1	1	1	1	1	1
40	T	12000	12000	7956	5304	3978	3182	2652	2273	1989	1768	1591	1447	1326	1224	1137	1061	995
	S	-	43	21	14	10	8	7	6	5	4	4	3	3	3	2	2	2
60	T	12000	12000	11934	7956	5967	4774	3978	3410	2984	2652	2387	2170	1989	1836	1705	1591	1492
	S	-	65	32	21	16	13	10	9	8	7	6	5	5	4	4	4	4
80	T	12000	12000	12000	10608	7956	6365	5304	4546	3978	3536	3182	2893	2652	2448	2273	2122	1989
	S	-	87	43	29	21	17	14	12	10	9	8	7	7	6	6	5	5
100	T	12000	12000	12000	12000	9945	7956	6630	5683	4973	4420	3978	3616	3315	3060	2841	2652	2486
	S	-	109	54	36	27	21	18	15	13	12	10	9	9	8	7	7	6
120	T	12000	12000	12000	12000	11934	9547	7956	6819	5967	5304	4774	4340	3978	3672	3410	3182	2984
	S	-	131	65	43	32	26	21	18	16	14	13	11	10	10	9	8	8
140	T	12000	12000	12000	12000	12000	11138	9282	7956	6962	6188	5569	5063	4641	4284	3978	3713	3481
	S	-	153	76	51	38	30	25	21	19	17	15	13	12	11	10	10	9
160	T	12000	12000	12000	12000	12000	10608	9093	7956	7072	6365	5786	5304	4896	4546	4243	3978	
	S	-	174	87	58	43	34	29	24	21	19	17	15	14	13	12	11	10
180	T	12000	12000	12000	12000	12000	11934	10229	8951	7956	7160	6509	5967	5508	5115	4774	4475	
	S	-	196	98	65	49	39	32	28	24	21	19	17	16	15	14	13	12
200	T	12000	12000	12000	12000	12000	12000	11366	9945	8840	7956	7233	6630	6120	5683	5304	4973	
	S	-	218	109	72	54	43	36	31	27	24	21	19	18	16	15	14	13
220	T	12000	12000	12000	12000	12000	12000	12000	10940	9724	8752	7956	7293	6732	6251	5834	5470	
	S	-	240	120	80	60	48	40	34	30	26	24	21	20	18	17	16	15
240	T	12000	12000	12000	12000	12000	12000	12000	11934	10608	9547	8679	7956	7344	6819	6365	5967	
	S	-	262	131	87	65	52	43	37	32	29	26	23	21	20	18	17	16
$k_1 \times b$ (-)	0,0	292,7	585,5	878,2	1170,9	1463,6	1756,4	2049,1	2341,8	2634,5	2927,3	3220,0	3512,7	3805,5	4098,2	4390,9	4683,6	

TTM: Timber-Timber-Maximum | TTP: Timber-Timber-Partial | TCM: Timber-Concrete-Maximum | TCP: Timber-Concrete-Partial

T: $F_{1,T,Rk}$ load-carrying capacity of timber | S: $F_{1,S,Rk}$ load-carrying capacity of steel

Table B. 150 Angle bracket type 6503SA4, Variant TTM, Fastener Profiled nail A4 4x40, Density 350 kg/m³Characteristic load-carrying capacity $F_{T,Rk}$ (N) for one / two angle brackets

angle bracket		1													2
f (mm)		0	10	20	30	40	50	60	70	80	90	100	110	120	0
$F_{T,Rk}$	T	1945	1652	1436	1270	1139	977	814	698	611	543	489	444	407	3889
	S	377	320	278	246	220	186	155	133	116	103	93	84	77	754

Characteristic load-carrying capacity $F_{2/3,Rk}$ (N) for one / two angle brackets

angle bracket		1	2
$F_{2/3,Rk}$	T	4830	9660
	S	-	-

Characteristic load-carrying capacity $F_{4,Rk}$ (N) for one angle bracket

e (mm)		0	20	40	60	80	100	120	140	160	180	200	220	240	260	280	300	320
$F_{4,Rk}$	T	16400	5494	2747	1831	1373	1099	769	585	472	396	340	299	266	240	219	201	185
	S	-	1065	532	355	266	213	147	111	90	75	65	57	50	45	41	38	35

Characteristic load-carrying capacity $F_{5,Rk}$ (N) for one angle bracket

b / e (mm)		0	20	40	60	80	100	120	140	160	180	200	220	240	260	280	300	320
0	T	865	1339	2961	2194	1645	1316	1097	940	823	731	658	598	548	506	470	439	411
	S	165	256	566	400	300	240	200	171	150	133	120	109	100	92	85	80	75
20	T	865	1339	2961	2194	1645	1316	1097	940	823	731	658	598	548	506	470	439	411
	S	165	256	566	400	300	240	200	171	150	133	120	109	100	92	85	80	75
40	T	865	1339	2961	2194	1645	1316	1097	940	823	731	658	598	548	506	470	439	411
	S	165	256	566	400	300	240	200	171	150	133	120	109	100	92	85	80	75
60	T	865	1339	2961	2194	1645	1316	1097	940	823	731	658	598	548	506	470	439	411
	S	165	256	566	400	300	240	200	171	150	133	120	109	100	92	85	80	75
80	T	865	1339	2961	2194	1645	1316	1097	940	823	731	658	598	548	506	470	439	411
	S	165	256	566	400	300	240	200	171	150	133	120	109	100	92	85	80	75
100	T	865	1339	2961	2194	1645	1316	1097	940	823	731	658	598	548	506	470	439	411
	S	165	256	566	400	300	240	200	171	150	133	120	109	100	92	85	80	75
120	T	865	1339	2961	2194	1645	1316	1097	940	823	731	658	598	548	506	470	439	411
	S	165	256	566	400	300	240	200	171	150	133	120	109	100	92	85	80	75
140	T	865	1339	2961	2194	1645	1316	1097	940	823	731	658	598	548	506	470	439	411
	S	165	256	566	400	300	240	200	171	150	133	120	109	100	92	85	80	75
160	T	865	1339	2961	2194	1645	1316	1097	940	823	731	658	598	548	506	470	439	411
	S	165	256	566	400	300	240	200	171	150	133	120	109	100	92	85	80	75
180	T	865	1339	2961	2194	1645	1316	1097	940	823	731	658	598	548	506	470	439	411
	S	165	256	566	400	300	240	200	171	150	133	120	109	100	92	85	80	75
200	T	865	1339	2961	2194	1645	1316	1097	940	823	731	658	598	548	506	470	439	411
	S	165	256	566	400	300	240	200	171	150	133	120	109	100	92	85	80	75
220	T	865	1339	2961	2194	1645	1316	1097	940	823	731	658	598	548	506	470	439	411
	S	165	256	566	400	300	240	200	171	150	133	120	109	100	92	85	80	75
240	T	865	1339	2961	2194	1645	1316	1097	940	823	731	658	598	548	506	470	439	411
	S	165	256	566	400	300	240	200	171	150	133	120	109	100	92	85	80	75

Characteristic load-carrying capacity $F_{4/5,Rk}$ (N) for two angle brackets

b / e (mm)		0	20	40	60	80	100	120	140	160	180	200	220	240	260	280	300	320
0	T	14400	14400	14400	14400	14400	14400	14400	14400	14400	14400	14400	14400	14400	14400	14400	14400	14400
	S	-	-	-	-	-	-	-	-	-	-	-	-	-	-	-	-	-
20	T	14400	1945	972	648	486	389	324	278	243	216	194	177	162	150	139	130	122
	S	-	377	188	125	94	75	62	53	47	41	37	34	31	29	26	25	23
40	T	14400	3889	1945	1296	972	778	648	556	486	432	389	354	324	299	278	259	243
	S	-	754	377	251	188	150	125	107	94	83	75	68	62	58	53	50	47
60	T	14400	5834	2917	1945	1458	1167	972	833	729	648	583	530	486	449	417	389	365
	S	-	1131	565	377	282	226	188	161	141	125	113	102	94	87	80	75	70
80	T	14400	7779	3889	2593	1945	1556	1296	1111	972	864	778	707	648	598	556	519	486
	S	-	1508	754	502	377	301	251	215	188	167	150	137	125	116	107	100	94
100	T	14400	9723	4862	3241	2431	1945	1621	1389	1215	1080	972	884	810	748	695	648	608
	S	-	1886	943	628	471	377	314	269	235	209	188	171	157	145	134	125	117
120	T	14400	11668	5834	3889	2917	2334	1945	1667	1458	1296	1167	1061	972	898	833	778	729
	S	-	2263	1131	754	565	452	377	323	282	251	226	205	188	174	161	150	141
140	T	14400	13613	6806	4538	3403	2723	2269	1945	1702	1513	1361	1238	1134	1047	972	908	851
	S	-	2640	1320	880	660	528	440	377	330	293	264	240	220	203	188	176	165
160	T	14400	14400	7779	5186	3889	3111	2593	2222	1945	1729	1556	1414	1296	1197	1111	1037	972
	S	-	3017	1508	1005	754	603	502	431	377	335	301	274	251	232	215	201	188
180	T	14400	14400	8751	5834	4375	3500	2917	2500	2188	1945	1750	1591	1458	1346	1250	1167	1094
	S	-	3395	1697	1131	848	679	565	485	424	377	339	308	282	261	242	226	212
200	T	14400	14400	9723	6482	4862	3889	3241	2778	2431	2161	1945	1768	1621	1496	1389	1296	1215
	S	-	3772	1886	1257	943	754	628	538	471	419	377	342	314	290	269	251	235
220	T	14400	14400	10696	7130	5348	4278	3565	3056	2674	2377	2139	1945	1783	1645	1528	1426	1337
	S	-	4149	2074	1383	1037	829	691	592	518	461	414	377	345	319	296	276	259
240	T	14400	14400	11668	7779	5834	4667	3889	3334	2917	2593	2334	2121	1945	1795	1667	1556	1458
	S	-	4526	2263	1508	1131	905	754	646	565	502	452	411	377	348	323	301	282

TTM: Timber-Timber-Maximum | TTP: Timber-Timber-Partial | TCM: Timber-Concrete-Maximum | TCP: Timber-Concrete-Partial

T: $F_{T,Rk}$ load-carrying capacity of timber | S: $F_{S,Rk}$ load-carrying capacity of steel

Table B. 151 Angle bracket type 6503SA4, Variant TTM, Fastener Profiled nail A4 4x60, Density 350 kg/m³Characteristic load-carrying capacity $F_{T,Rk}$ (N) for one / two angle brackets

angle bracket		1													2
f (mm)		0	10	20	30	40	50	60	70	80	90	100	110	120	0
$F_{T,Rk}$	T	3241	2754	2394	2117	1898	1629	1357	1163	1018	905	814	740	679	6482
	S	377	320	278	246	220	186	155	133	116	103	93	84	77	754

Characteristic load-carrying capacity $F_{2/3,Rk}$ (N) for one / two angle brackets

angle bracket		1	2
$F_{2/3,Rk}$	T	6090	12180
	S	-	-

Characteristic load-carrying capacity $F_{4,Rk}$ (N) for one angle bracket

e (mm)		0	20	40	60	80	100	120	140	160	180	200	220	240	260	280	300	320
$F_{4,Rk}$	T	19889	9156	4578	3052	2289	1831	1282	975	787	659	567	498	444	400	364	334	309
	S	-	1065	532	355	266	213	147	111	90	75	65	57	50	45	41	38	35

Characteristic load-carrying capacity $F_{5,Rk}$ (N) for one angle bracket

b / e (mm)		0	20	40	60	80	100	120	140	160	180	200	220	240	260	280	300	320
0	T	1441	2231	4935	3656	2742	2194	1828	1567	1371	1219	1097	997	914	844	783	731	686
	S	165	256	566	400	300	240	200	171	150	133	120	109	100	92	85	80	75
20	T	1441	2231	4935	3656	2742	2194	1828	1567	1371	1219	1097	997	914	844	783	731	686
	S	165	256	566	400	300	240	200	171	150	133	120	109	100	92	85	80	75
40	T	1441	2231	4935	3656	2742	2194	1828	1567	1371	1219	1097	997	914	844	783	731	686
	S	165	256	566	400	300	240	200	171	150	133	120	109	100	92	85	80	75
60	T	1441	2231	4935	3656	2742	2194	1828	1567	1371	1219	1097	997	914	844	783	731	686
	S	165	256	566	400	300	240	200	171	150	133	120	109	100	92	85	80	75
80	T	1441	2231	4935	3656	2742	2194	1828	1567	1371	1219	1097	997	914	844	783	731	686
	S	165	256	566	400	300	240	200	171	150	133	120	109	100	92	85	80	75
100	T	1441	2231	4935	3656	2742	2194	1828	1567	1371	1219	1097	997	914	844	783	731	686
	S	165	256	566	400	300	240	200	171	150	133	120	109	100	92	85	80	75
120	T	1441	2231	4935	3656	2742	2194	1828	1567	1371	1219	1097	997	914	844	783	731	686
	S	165	256	566	400	300	240	200	171	150	133	120	109	100	92	85	80	75
140	T	1441	2231	4935	3656	2742	2194	1828	1567	1371	1219	1097	997	914	844	783	731	686
	S	165	256	566	400	300	240	200	171	150	133	120	109	100	92	85	80	75
160	T	1441	2231	4935	3656	2742	2194	1828	1567	1371	1219	1097	997	914	844	783	731	686
	S	165	256	566	400	300	240	200	171	150	133	120	109	100	92	85	80	75
180	T	1441	2231	4935	3656	2742	2194	1828	1567	1371	1219	1097	997	914	844	783	731	686
	S	165	256	566	400	300	240	200	171	150	133	120	109	100	92	85	80	75
200	T	1441	2231	4935	3656	2742	2194	1828	1567	1371	1219	1097	997	914	844	783	731	686
	S	165	256	566	400	300	240	200	171	150	133	120	109	100	92	85	80	75
220	T	1441	2231	4935	3656	2742	2194	1828	1567	1371	1219	1097	997	914	844	783	731	686
	S	165	256	566	400	300	240	200	171	150	133	120	109	100	92	85	80	75
240	T	1441	2231	4935	3656	2742	2194	1828	1567	1371	1219	1097	997	914	844	783	731	686
	S	165	256	566	400	300	240	200	171	150	133	120	109	100	92	85	80	75

Characteristic load-carrying capacity $F_{4/5,Rk}$ (N) for two angle brackets

b / e (mm)		0	20	40	60	80	100	120	140	160	180	200	220	240	260	280	300	320
0	T	23999	23999	23999	23999	23999	23999	23999	23999	23999	23999	23999	23999	23999	23999	23999	23999	23999
	S	-	-	-	-	-	-	-	-	-	-	-	-	-	-	-	-	-
20	T	23999	3241	1621	1080	810	648	540	463	405	360	324	295	270	249	232	216	203
	S	-	377	188	125	94	75	62	53	47	41	37	34	31	29	26	25	23
40	T	23999	6482	3241	2161	1621	1296	1080	926	810	720	648	589	540	499	463	432	405
	S	-	754	377	251	188	150	125	107	94	83	75	68	62	58	53	50	47
60	T	23999	9723	4862	3241	2431	1945	1621	1389	1215	1080	972	884	810	748	695	648	608
	S	-	1131	565	377	282	226	188	161	141	125	113	102	94	87	80	75	70
80	T	23999	12964	6482	4321	3241	2593	2161	1852	1621	1440	1296	1179	1080	997	926	864	810
	S	-	1508	754	502	377	301	251	215	188	167	150	137	125	116	107	100	94
100	T	23999	16205	8103	5402	4051	3241	2701	2315	2026	1801	1621	1473	1350	1247	1158	1080	1013
	S	-	1886	943	628	471	377	314	269	235	209	188	171	157	145	134	125	117
120	T	23999	19447	9723	6482	4862	3889	3241	2778	2431	2161	1945	1768	1621	1496	1389	1296	1215
	S	-	2263	1131	754	565	452	377	323	282	251	226	205	188	174	161	150	141
140	T	23999	22688	11344	7563	5672	4538	3781	3241	2836	2521	2269	2063	1891	1745	1621	1513	1418
	S	-	2640	1320	880	660	528	440	377	330	293	264	240	220	203	188	176	165
160	T	23999	24000	12964	8643	6482	5186	4321	3704	3241	2881	2593	2357	2161	1995	1852	1729	1621
	S	-	3017	1508	1005	754	603	502	431	377	335	301	274	251	232	215	201	188
180	T	23999	24000	14585	9723	7292	5834	4862	4167	3646	3241	2917	2652	2431	2244	2084	1945	1823
	S	-	3395	1697	1131	848	679	565	485	424	377	339	308	282	261	242	226	212
200	T	23999	24000	16205	10804	8103	6482	5402	4630	4051	3601	3241	2946	2701	2493	2315	2161	2026
	S	-	3772	1886	1257	943	754	628	538	471	419	377	342	314	290	269	251	235
220	T	23999	24000	17826	11884	8913	7130	5942	5093	4456	3961	3565	3241	2971	2742	2547	2377	2228
	S	-	4149	2074	1383	1037	829	691	592	518	461	414	377	345	319	296	276	259
240	T	23999	24000	19447	12964	9723	7779	6482	5556	4862	4321	3889	3536	3241	2992	2778	2593	2431
	S	-	4526	2263	1508	1131	905	754	646	565	502	452	411	377	348	323	301	282

TTM: Timber-Timber-Maximum | TTP: Timber-Timber-Partial | TCM: Timber-Concrete-Maximum | TCP: Timber-Concrete-Partial

T: $F_{T,Rk}$ load-carrying capacity of timber | S: $F_{S,Rk}$ load-carrying capacity of steel

Table B. 152 Angle bracket type 6503SA4, Variant TTP, Fastener Profiled nail A4 4x40, Density 350 kg/m³Characteristic load-carrying capacity $F_{T,Rk}$ (N) for one / two angle brackets

angle bracket		1													2
f (mm)		0	10	20	30	40	50	60	70	80	90	100	110	120	0
$F_{T,Rk}$	T	1833	1557	1354	1197	1013	810	675	579	506	450	405	368	338	3665
	S	585	497	432	382	342	310	264	226	198	176	158	144	132	1170

Characteristic load-carrying capacity $F_{2/3,Rk}$ (N) for one / two angle brackets

angle bracket		1	2
$F_{2/3,Rk}$	T	3150	6300
	S	-	-

Characteristic load-carrying capacity $F_{4,Rk}$ (N) for one angle bracket

e (mm)		0	20	40	60	80	100	120	140	160	180	200	220	240	260	280	300	320
$F_{4,Rk}$	T	9840	5177	2589	1726	1294	931	638	485	391	328	282	248	221	199	181	166	154
	S	-	1200	600	400	300	240	200	171	150	128	110	97	86	78	71	65	60

Characteristic load-carrying capacity $F_{5,Rk}$ (N) for one angle bracket

b / e (mm)		0	20	40	60	80	100	120	140	160	180	200	220	240	260	280	300	320
0	T	717	1110	1869	1020	765	612	510	437	383	340	306	278	255	235	219	204	191
	S	281	435	600	400	300	240	200	171	150	133	120	109	100	92	85	80	75
20	T	717	1110	2455	1020	765	612	510	437	383	340	306	278	255	235	219	204	191
	S	281	435	600	400	300	240	200	171	150	133	120	109	100	92	85	80	75
40	T	717	1110	2455	1020	765	612	510	437	383	340	306	278	255	235	219	204	191
	S	281	435	600	400	300	240	200	171	150	133	120	109	100	92	85	80	75
60	T	717	1110	2455	1020	765	612	510	437	383	340	306	278	255	235	219	204	191
	S	281	435	600	400	300	240	200	171	150	133	120	109	100	92	85	80	75
80	T	717	1110	2455	1020	765	612	510	437	383	340	306	278	255	235	219	204	191
	S	281	435	600	400	300	240	200	171	150	133	120	109	100	92	85	80	75
100	T	717	1110	2455	1020	765	612	510	437	383	340	306	278	255	235	219	204	191
	S	281	435	600	400	300	240	200	171	150	133	120	109	100	92	85	80	75
120	T	717	1110	2455	1020	765	612	510	437	383	340	306	278	255	235	219	204	191
	S	281	435	600	400	300	240	200	171	150	133	120	109	100	92	85	80	75
140	T	717	1110	2455	1020	765	612	510	437	383	340	306	278	255	235	219	204	191
	S	281	435	600	400	300	240	200	171	150	133	120	109	100	92	85	80	75
160	T	717	1110	2455	1020	765	612	510	437	383	340	306	278	255	235	219	204	191
	S	281	435	600	400	300	240	200	171	150	133	120	109	100	92	85	80	75
180	T	717	1110	2455	1020	765	612	510	437	383	340	306	278	255	235	219	204	191
	S	281	435	600	400	300	240	200	171	150	133	120	109	100	92	85	80	75
200	T	717	1110	2455	1020	765	612	510	437	383	340	306	278	255	235	219	204	191
	S	281	435	600	400	300	240	200	171	150	133	120	109	100	92	85	80	75
220	T	717	1110	2455	1020	765	612	510	437	383	340	306	278	255	235	219	204	191
	S	281	435	600	400	300	240	200	171	150	133	120	109	100	92	85	80	75
240	T	717	1110	2455	1020	765	612	510	437	383	340	306	278	255	235	219	204	191
	S	281	435	600	400	300	240	200	171	150	133	120	109	100	92	85	80	75

Characteristic load-carrying capacity $F_{4/5,Rk}$ (N) for two angle brackets

b / e (mm)		0	20	40	60	80	100	120	140	160	180	200	220	240	260	280	300	320
0	T	7199	7199	7199	7199	7199	7199	7199	7199	7199	7199	7199	7199	7199	7199	7199	7199	7199
	S	-	-	-	-	-	-	-	-	-	-	-	-	-	-	-	-	-
20	T	7199	1833	916	611	458	367	305	262	229	204	183	167	153	141	131	122	115
	S	-	585	292	195	146	117	97	83	73	65	58	53	48	45	41	39	36
40	T	7199	3665	1833	1222	916	733	611	524	458	407	367	333	305	282	262	244	229
	S	-	1171	585	390	292	234	195	167	146	130	117	106	97	90	83	78	73
60	T	7199	5498	2749	1833	1375	1100	916	785	687	611	550	500	458	423	393	367	344
	S	-	1757	878	585	439	351	292	251	219	195	175	159	146	135	125	117	109
80	T	7199	7200	3665	2444	1833	1466	1222	1047	916	815	733	666	611	564	524	489	458
	S	-	2343	1171	781	585	468	390	334	292	260	234	213	195	180	167	156	146
100	T	7199	7200	4582	3055	2291	1833	1527	1309	1145	1018	916	833	764	705	655	611	573
	S	-	2928	1464	976	732	585	488	418	366	325	292	266	244	225	209	195	183
120	T	7199	7200	5498	3665	2749	2199	1833	1571	1375	1222	1100	1000	916	846	785	733	687
	S	-	3514	1757	1171	878	702	585	502	439	390	351	319	292	270	251	234	219
140	T	7199	7200	6415	4276	3207	2566	2138	1833	1604	1425	1283	1166	1069	987	916	855	802
	S	-	4100	2050	1366	1025	820	683	585	512	455	410	372	341	315	292	273	256
160	T	7199	7200	7200	4887	3665	2932	2444	2095	1833	1629	1466	1333	1222	1128	1047	977	916
	S	-	4686	2343	1562	1171	937	781	669	585	520	468	426	390	360	334	312	292
180	T	7199	7200	7200	5498	4124	3299	2749	2356	2062	1833	1649	1499	1375	1269	1178	1100	1031
	S	-	5271	2635	1757	1317	1054	878	753	658	585	527	479	439	405	376	351	329
200	T	7199	7200	7200	6109	4582	3665	3055	2618	2291	2036	1833	1666	1527	1410	1309	1222	1145
	S	-	5857	2928	1952	1464	1171	976	836	732	650	585	532	488	450	418	390	366
220	T	7199	7200	7200	6720	5040	4032	3360	2880	2520	2240	2016	1833	1680	1551	1440	1344	1260
	S	-	6443	3221	2147	1610	1288	1073	920	805	715	644	585	536	495	460	429	402
240	T	7199	7200	7200	7200	5498	4399	3665	3142	2749	2444	2199	1999	1833	1692	1571	1466	1375
	S	-	7029	3514	2343	1757	1405	1171	1004	878	781	702	639	585	540	502	468	439

TTM: Timber-Timber-Maximum | TTP: Timber-Timber-Partial | TCM: Timber-Concrete-Maximum | TCP: Timber-Concrete-Partial

T: $F_{T,Rk}$ load-carrying capacity of timber | S: $F_{S,Rk}$ load-carrying capacity of steel

Table B. 153 Angle bracket type 6503SA4, Variant TTP, Fastener Profiled nail A4 4x60, Density 350 kg/m³Characteristic load-carrying capacity $F_{T,Rk}$ (N) for one / two angle brackets

angle bracket		1													2
f (mm)		0	10	20	30	40	50	60	70	80	90	100	110	120	0
$F_{T,Rk}$	T	3055	2595	2256	1995	1688	1350	1125	964	844	750	675	614	563	6109
	S	585	497	432	382	342	310	264	226	198	176	158	144	132	1170

Characteristic load-carrying capacity $F_{2/3,Rk}$ (N) for one / two angle brackets

angle bracket		1	2
$F_{2/3,Rk}$	T	4040	8080
	S	-	-

Characteristic load-carrying capacity $F_{4,Rk}$ (N) for one angle bracket

e (mm)		0	20	40	60	80	100	120	140	160	180	200	220	240	260	280	300	320
$F_{4,Rk}$	T	11934	8629	4315	2876	2157	1552	1063	808	652	547	470	413	368	332	302	277	256
	S	-	1200	600	400	300	240	200	171	150	128	110	97	86	78	71	65	60

Characteristic load-carrying capacity $F_{5,Rk}$ (N) for one angle bracket

b / e (mm)		0	20	40	60	80	100	120	140	160	180	200	220	240	260	280	300	320
0	T	1195	1849	3115	1700	1275	1020	850	729	638	567	510	464	425	392	364	340	319
	S	281	435	600	400	300	240	200	171	150	133	120	109	100	92	85	80	75
20	T	1195	1849	4091	1700	1275	1020	850	729	638	567	510	464	425	392	364	340	319
	S	281	435	600	400	300	240	200	171	150	133	120	109	100	92	85	80	75
40	T	1195	1849	4091	1700	1275	1020	850	729	638	567	510	464	425	392	364	340	319
	S	281	435	600	400	300	240	200	171	150	133	120	109	100	92	85	80	75
60	T	1195	1849	4091	1700	1275	1020	850	729	638	567	510	464	425	392	364	340	319
	S	281	435	600	400	300	240	200	171	150	133	120	109	100	92	85	80	75
80	T	1195	1849	4091	1700	1275	1020	850	729	638	567	510	464	425	392	364	340	319
	S	281	435	600	400	300	240	200	171	150	133	120	109	100	92	85	80	75
100	T	1195	1849	4091	1700	1275	1020	850	729	638	567	510	464	425	392	364	340	319
	S	281	435	600	400	300	240	200	171	150	133	120	109	100	92	85	80	75
120	T	1195	1849	4091	1700	1275	1020	850	729	638	567	510	464	425	392	364	340	319
	S	281	435	600	400	300	240	200	171	150	133	120	109	100	92	85	80	75
140	T	1195	1849	4091	1700	1275	1020	850	729	638	567	510	464	425	392	364	340	319
	S	281	435	600	400	300	240	200	171	150	133	120	109	100	92	85	80	75
160	T	1195	1849	4091	1700	1275	1020	850	729	638	567	510	464	425	392	364	340	319
	S	281	435	600	400	300	240	200	171	150	133	120	109	100	92	85	80	75
180	T	1195	1849	4091	1700	1275	1020	850	729	638	567	510	464	425	392	364	340	319
	S	281	435	600	400	300	240	200	171	150	133	120	109	100	92	85	80	75
200	T	1195	1849	4091	1700	1275	1020	850	729	638	567	510	464	425	392	364	340	319
	S	281	435	600	400	300	240	200	171	150	133	120	109	100	92	85	80	75
220	T	1195	1849	4091	1700	1275	1020	850	729	638	567	510	464	425	392	364	340	319
	S	281	435	600	400	300	240	200	171	150	133	120	109	100	92	85	80	75
240	T	1195	1849	4091	1700	1275	1020	850	729	638	567	510	464	425	392	364	340	319
	S	281	435	600	400	300	240	200	171	150	133	120	109	100	92	85	80	75

Characteristic load-carrying capacity $F_{4/5,Rk}$ (N) for two angle brackets

b / e (mm)		0	20	40	60	80	100	120	140	160	180	200	220	240	260	280	300	320
0	T	12000	12000	12000	12000	12000	12000	12000	12000	12000	12000	12000	12000	12000	12000	12000	12000	12000
	S	-	-	-	-	-	-	-	-	-	-	-	-	-	-	-	-	-
20	T	12000	3055	1527	1018	764	611	509	436	382	339	305	278	255	235	218	204	191
	S	-	585	292	195	146	117	97	83	73	65	58	53	48	45	41	39	36
40	T	12000	6109	3055	2036	1527	1222	1018	873	764	679	611	555	509	470	436	407	382
	S	-	1171	585	390	292	234	195	167	146	130	117	106	97	90	83	78	73
60	T	12000	9164	4582	3055	2291	1833	1527	1309	1145	1018	916	833	764	705	655	611	573
	S	-	1757	878	585	439	351	292	251	219	195	175	159	146	135	125	117	109
80	T	12000	12000	6109	4073	3055	2444	2036	1745	1527	1358	1222	1111	1018	940	873	815	764
	S	-	2343	1171	781	585	468	390	334	292	260	234	213	195	180	167	156	146
100	T	12000	12000	7636	5091	3818	3055	2545	2182	1909	1697	1527	1388	1273	1175	1091	1018	955
	S	-	2928	1464	976	732	585	488	418	366	325	292	266	244	225	209	195	183
120	T	12000	12000	9164	6109	4582	3665	3055	2618	2291	2036	1833	1666	1527	1410	1309	1222	1145
	S	-	3514	1757	1171	878	702	585	502	439	390	351	319	292	270	251	234	219
140	T	12000	12000	10691	7127	5345	4276	3564	3055	2673	2376	2138	1944	1782	1645	1527	1425	1336
	S	-	4100	2050	1366	1025	820	683	585	512	455	410	372	341	315	292	273	256
160	T	12000	12000	12000	8145	6109	4887	4073	3491	3055	2715	2444	2221	2036	1880	1745	1629	1527
	S	-	4686	2343	1562	1171	937	781	669	585	520	468	426	390	360	334	312	292
180	T	12000	12000	12000	9164	6873	5498	4582	3927	3436	3055	2749	2499	2291	2115	1964	1833	1718
	S	-	5271	2635	1757	1317	1054	878	753	658	585	527	479	439	405	376	351	329
200	T	12000	12000	12000	10182	7636	6109	5091	4364	3818	3394	3055	2777	2545	2350	2182	2036	1909
	S	-	5857	2928	1952	1464	1171	976	836	732	650	585	532	488	450	418	390	366
220	T	12000	12000	12000	11200	8400	6720	5600	4800	4200	3733	3360	3055	2800	2585	2400	2240	2100
	S	-	6443	3221	2147	1610	1288	1073	920	805	715	644	585	536	495	460	429	402
240	T	12000	12000	12000	12000	9164	7331	6109	5236	4582	4073	3665	3332	3055	2820	2618	2444	2291
	S	-	7029	3514	2343	1757	1405	1171	1004	878	781	702	639	585	540	502	468	439

TTM: Timber-Timber-Maximum | TTP: Timber-Timber-Partial | TCM: Timber-Concrete-Maximum | TCP: Timber-Concrete-Partial

T: $F_{T,Rk}$ load-carrying capacity of timber | S: $F_{S,Rk}$ load-carrying capacity of steel

Table B. 154 Angle bracket type 6504SA4, Variant TCM, Fastener Profiled nail A4 4x40, Density 350 kg/m³Characteristic load-carrying capacity $F_{1,Rk}$ (N) for one / two angle brackets

angle bracket		1													2
f (mm)		0	10	20	30	40	50	60	70	80	90	100	110	120	0
$F_{1,Rk}$	T	13120	450	225	150	113	90	75	64	56	50	45	41	38	26240
	S	57	48	41	36	32	29	26	24	21	19	17	15	14	
k_t (-)		9,2	11,0	12,8	14,6	16,5	18,3	20,1	21,9	23,7	25,5	27,4	29,2	31,0	4,6

Characteristic load-carrying capacity $F_{2/3,Rk}$ (N) for one / two angle brackets

angle bracket		1	2
$F_{2/3,Rk}$	T	2430	4860
	S	-	-

Characteristic load-carrying capacity $F_{4,Rk}$ (N) for one angle bracket

e (mm)		0	20	40	60	80	100	120	140	160	180	200	220	240	260	280	300	320
$F_{4,Rk}$	T	-	-	1286	191	103	71	54	43	36	31	28	25	22	20	18	17	16
	S	-	145	72	48	36	27	21	16	14	12	10	9	8	7	7	6	6
k_t (-)		0,0	3,6	7,3	10,9	14,5	18,2	21,8	25,5	29,1	32,7	36,4	40,0	43,6	47,3	50,9	54,5	58,2

Characteristic load-carrying capacity $F_{5,Rk}$ (N) for one angle bracket

b / e (mm)		0	20	40	60	80	100	120	140	160	180	200	220	240	260	280	300	320
0	T	123	273	1530	1020	765	612	510	437	383	340	306	278	255	235	219	204	191
	S	48	106	596	397	298	238	198	170	149	132	119	108	99	91	85	79	74
20	T	123	273	1530	1020	765	612	510	437	383	340	306	278	255	235	219	204	191
	S	48	106	596	397	298	238	198	170	149	132	119	108	99	91	85	79	74
40	T	123	273	1530	1020	765	612	510	437	383	340	306	278	255	235	219	204	191
	S	48	106	596	397	298	238	198	170	149	132	119	108	99	91	85	79	74
60	T	123	273	1530	1020	765	612	510	437	383	340	306	278	255	235	219	204	191
	S	48	106	596	397	298	238	198	170	149	132	119	108	99	91	85	79	74
80	T	123	273	1530	1020	765	612	510	437	383	340	306	278	255	235	219	204	191
	S	48	106	596	397	298	238	198	170	149	132	119	108	99	91	85	79	74
100	T	123	273	1530	1020	765	612	510	437	383	340	306	278	255	235	219	204	191
	S	48	106	596	397	298	238	198	170	149	132	119	108	99	91	85	79	74
120	T	123	273	1530	1020	765	612	510	437	383	340	306	278	255	235	219	204	191
	S	48	106	596	397	298	238	198	170	149	132	119	108	99	91	85	79	74
140	T	123	273	1530	1020	765	612	510	437	383	340	306	278	255	235	219	204	191
	S	48	106	596	397	298	238	198	170	149	132	119	108	99	91	85	79	74
160	T	123	273	1530	1020	765	612	510	437	383	340	306	278	255	235	219	204	191
	S	48	106	596	397	298	238	198	170	149	132	119	108	99	91	85	79	74
180	T	123	273	1530	1020	765	612	510	437	383	340	306	278	255	235	219	204	191
	S	48	106	596	397	298	238	198	170	149	132	119	108	99	91	85	79	74
200	T	123	273	1530	1020	765	612	510	437	383	340	306	278	255	235	219	204	191
	S	48	106	596	397	298	238	198	170	149	132	119	108	99	91	85	79	74
220	T	123	273	1530	1020	765	612	510	437	383	340	306	278	255	235	219	204	191
	S	48	106	596	397	298	238	198	170	149	132	119	108	99	91	85	79	74
240	T	123	273	1530	1020	765	612	510	437	383	340	306	278	255	235	219	204	191
	S	48	106	596	397	298	238	198	170	149	132	119	108	99	91	85	79	74
$k_t \times b$ (-)		0,0	16,8	33,7	50,5	67,4	84,2	101,1	117,9	134,7	151,6	168,4	185,3	202,1	218,9	235,8	252,6	269,5

Characteristic load-carrying capacity $F_{4/5,Rk}$ (N) for two angle brackets

b / e (mm)		0	20	40	60	80	100	120	140	160	180	200	220	240	260	280	300	320
0	T	14400	14400	14400	14400	14400	14400	14400	14400	14400	14400	14400	14400	14400	14400	14400	14400	14400
	S	-	-	-	-	-	-	-	-	-	-	-	-	-	-	-	-	-
20	T	14400	13120	6560	4373	3280	2624	2187	1874	1640	1458	1312	1193	1093	1009	937	875	820
	S	-	57	28	19	14	11	9	8	7	6	5	5	4	4	4	3	3
40	T	14400	14400	13120	8747	6560	5248	4373	3749	3280	2916	2624	2385	2187	2018	1874	1749	1640
	S	-	115	57	38	28	23	19	16	14	12	11	10	9	8	8	7	7
60	T	14400	14400	14400	13120	9840	7872	6560	5623	4920	4373	3936	3578	3280	3028	2811	2624	2460
	S	-	173	86	57	43	34	28	24	21	19	17	15	14	13	12	11	10
80	T	14400	14400	14400	14400	13120	10496	8747	7497	6560	5831	5248	4771	4373	4037	3749	3499	3280
	S	-	231	115	77	57	46	38	33	28	25	23	21	19	17	16	15	14
100	T	14400	14400	14400	14400	14400	13120	10933	9371	8200	7289	6560	5964	5467	5046	4686	4373	4100
	S	-	288	144	96	72	57	48	41	36	32	28	26	24	22	20	19	18
120	T	14400	14400	14400	14400	14400	14400	13120	11246	9840	8747	7872	7156	6560	6055	5623	5248	4920
	S	-	346	173	115	86	69	57	49	43	38	34	31	28	26	24	23	21
140	T	14400	14400	14400	14400	14400	14400	13120	11480	10204	9184	8349	7653	7065	6560	6123	5740	5400
	S	-	404	202	134	101	80	67	57	50	44	40	36	33	31	28	26	25
160	T	14400	14400	14400	14400	14400	14400	14400	14400	13120	11662	10496	9542	8747	8074	7497	6997	6560
	S	-	462	231	154	115	92	77	66	57	51	46	42	38	35	33	30	28
180	T	14400	14400	14400	14400	14400	14400	14400	14400	14400	13120	11808	10735	9840	9083	8434	7872	7380
	S	-	519	259	173	129	103	86	74	64	57	51	47	43	39	37	34	32
200	T	14400	14400	14400	14400	14400	14400	14400	14400	14400	14400	13120	11927	10933	10092	9371	8747	8200
	S	-	577	288	192	144	115	96	82	72	64	57	52	48	44	41	38	36
220	T	14400	14400	14400	14400	14400	14400	14400	14400	14400	14400	14400	13120	12027	11102	10309	9621	9020
	S	-	635	317	211	158	127	105	90	79	70	63	57	52	48	45	42	39
240	T	14400	14400	14400	14400	14400	14400	14400	14400	14400	14400	14400	14400	14313	13120	12111	11246	10496
	S	-	693	346	231	173	138	115	99	86	77	69	63	57	53	49	46	43
$k_t \times b$ (-)		0,0	183,6	367,3	550,9	734,5	918,2	1101,8	1285,5	1469,1	1652,7	1836,4	2020,0	2203,6	2387,3	2570,9	2754,5	2938,2

TTM: Timber-Timber-Maximum | TTP: Timber-Timber-Partial | TCM: Timber-Concrete-Maximum | TCP: Timber-Concrete-Partial

T: $F_{1,T,Rk}$ load-carrying capacity of timber | S: $F_{1,S,Rk}$ load-carrying capacity of steel

Table B. 155 Angle bracket type 6504SA4, Variant TCM, Fastener Profiled nail A4 4x60, Density 350 kg/m³Characteristic load-carrying capacity $F_{1,Rk}$ (N) for one / two angle brackets

angle bracket		1													2
f (mm)		0	10	20	30	40	50	60	70	80	90	100	110	120	0
$F_{1,Rk}$	T	15912	750	375	250	188	150	125	107	94	83	75	68	63	31824
	S	57	48	41	36	32	29	26	24	21	19	17	15	14	
$k_1 (-)$		9,2	11,0	12,8	14,6	16,5	18,3	20,1	21,9	23,7	25,5	27,4	29,2	31,0	4,6

Characteristic load-carrying capacity $F_{2/3,Rk}$ (N) for one / two angle brackets

angle bracket		1	2
$F_{2/3,Rk}$	T	3430	6860
	S	-	-

Characteristic load-carrying capacity $F_{4,Rk}$ (N) for one angle bracket

e (mm)		0	20	40	60	80	100	120	140	160	180	200	220	240	260	280	300	320
$F_{4,Rk}$	T	-	-	2143	319	172	118	90	72	61	52	46	41	37	34	31	28	26
	S	-	145	72	48	36	27	21	16	14	12	10	9	8	7	7	6	6
$k_1 (-)$		0,0	3,6	7,3	10,9	14,5	18,2	21,8	25,5	29,1	32,7	36,4	40,0	43,6	47,3	50,9	54,5	58,2

Characteristic load-carrying capacity $F_{5,Rk}$ (N) for one angle bracket

b / e (mm)		0	20	40	60	80	100	120	140	160	180	200	220	240	260	280	300	320
0	T	205	455	2550	1700	1275	1020	850	729	638	567	510	464	425	392	364	340	319
	S	48	106	596	397	298	238	198	170	149	132	119	108	99	91	85	79	74
20	T	205	455	2550	1700	1275	1020	850	729	638	567	510	464	425	392	364	340	319
	S	48	106	596	397	298	238	198	170	149	132	119	108	99	91	85	79	74
40	T	205	455	2550	1700	1275	1020	850	729	638	567	510	464	425	392	364	340	319
	S	48	106	596	397	298	238	198	170	149	132	119	108	99	91	85	79	74
60	T	205	455	2550	1700	1275	1020	850	729	638	567	510	464	425	392	364	340	319
	S	48	106	596	397	298	238	198	170	149	132	119	108	99	91	85	79	74
80	T	205	455	2550	1700	1275	1020	850	729	638	567	510	464	425	392	364	340	319
	S	48	106	596	397	298	238	198	170	149	132	119	108	99	91	85	79	74
100	T	205	455	2550	1700	1275	1020	850	729	638	567	510	464	425	392	364	340	319
	S	48	106	596	397	298	238	198	170	149	132	119	108	99	91	85	79	74
120	T	205	455	2550	1700	1275	1020	850	729	638	567	510	464	425	392	364	340	319
	S	48	106	596	397	298	238	198	170	149	132	119	108	99	91	85	79	74
140	T	205	455	2550	1700	1275	1020	850	729	638	567	510	464	425	392	364	340	319
	S	48	106	596	397	298	238	198	170	149	132	119	108	99	91	85	79	74
160	T	205	455	2550	1700	1275	1020	850	729	638	567	510	464	425	392	364	340	319
	S	48	106	596	397	298	238	198	170	149	132	119	108	99	91	85	79	74
180	T	205	455	2550	1700	1275	1020	850	729	638	567	510	464	425	392	364	340	319
	S	48	106	596	397	298	238	198	170	149	132	119	108	99	91	85	79	74
200	T	205	455	2550	1700	1275	1020	850	729	638	567	510	464	425	392	364	340	319
	S	48	106	596	397	298	238	198	170	149	132	119	108	99	91	85	79	74
220	T	205	455	2550	1700	1275	1020	850	729	638	567	510	464	425	392	364	340	319
	S	48	106	596	397	298	238	198	170	149	132	119	108	99	91	85	79	74
240	T	205	455	2550	1700	1275	1020	850	729	638	567	510	464	425	392	364	340	319
	S	48	106	596	397	298	238	198	170	149	132	119	108	99	91	85	79	74
$k_1 \times b (-)$		0,0	16,8	33,7	50,5	67,4	84,2	101,1	117,9	134,7	151,6	168,4	185,3	202,1	218,9	235,8	252,6	269,5

Characteristic load-carrying capacity $F_{4/5,Rk}$ (N) for two angle brackets

b / e (mm)		0	20	40	60	80	100	120	140	160	180	200	220	240	260	280	300	320
0	T	23999	23999	23999	23999	23999	23999	23999	23999	23999	23999	23999	23999	23999	23999	23999	23999	23999
	S	-	-	-	-	-	-	-	-	-	-	-	-	-	-	-	-	-
20	T	23999	15912	7956	5304	3978	3182	2652	2273	1989	1768	1591	1447	1326	1224	1137	1061	995
	S	-	57	28	19	14	11	9	8	7	6	5	5	4	4	4	3	3
40	T	23999	24000	15912	10608	7956	6365	5304	4546	3978	3536	3182	2893	2652	2448	2273	2122	1989
	S	-	115	57	38	28	23	19	16	14	12	11	10	9	8	8	7	7
60	T	23999	24000	23868	15912	11934	9547	7956	6819	5967	5304	4774	4340	3978	3672	3410	3182	2984
	S	-	173	86	57	43	34	28	24	21	19	17	15	14	13	12	11	10
80	T	23999	24000	24000	21216	15912	12730	10608	9093	7956	7072	6365	5786	5304	4896	4546	4243	3978
	S	-	231	115	77	57	46	38	33	28	25	23	21	19	17	16	15	14
100	T	23999	24000	24000	24000	19890	15912	13260	11366	9945	8840	7956	7233	6630	6120	5683	5304	4973
	S	-	288	144	96	72	57	48	41	36	32	28	26	24	22	20	19	18
120	T	23999	24000	24000	24000	23868	19094	15912	13639	11934	10608	9547	8679	7956	7344	6819	6365	5967
	S	-	346	173	115	86	69	57	49	43	38	34	31	28	26	24	23	21
140	T	23999	24000	24000	24000	24000	22277	18564	15912	13923	12376	11138	10126	9282	8568	7956	7426	6962
	S	-	404	202	134	101	80	67	57	50	44	40	36	33	31	28	26	25
160	T	23999	24000	24000	24000	24000	21216	18185	15912	14144	12730	11572	10608	9792	9093	8486	7956	
	S	-	462	231	154	115	92	77	66	57	51	46	42	38	35	33	30	28
180	T	23999	24000	24000	24000	24000	23868	20458	17901	15912	14321	13019	11934	11016	10229	9547	8951	
	S	-	519	259	173	129	103	86	74	64	57	51	47	43	39	37	34	32
200	T	23999	24000	24000	24000	24000	24000	22731	19890	17680	15912	14465	13260	12240	11366	10608	9945	
	S	-	577	288	192	144	115	96	82	72	64	57	52	48	44	41	38	36
220	T	23999	24000	24000	24000	24000	24000	24000	21879	19448	17503	15912	14586	13464	12502	11669	10940	
	S	-	635	317	211	158	127	105	90	79	70	63	57	52	48	45	42	39
240	T	23999	24000	24000	24000	24000	24000	24000	23868	21216	19094	17359	15912	14688	13639	12730	11934	
	S	-	693	346	231	173	138	115	99	86	77	69	63	57	53	49	46	43
$k_1 \times b (-)$		0,0	183,6	367,3	550,9	734,5	918,2	1101,8	1285,5	1469,1	1652,7	1836,4	2020,0	2203,6	2387,3	2570,9	2754,5	2938,2

TTM: Timber-Timber-Maximum | TTP: Timber-Timber-Partial | TCM: Timber-Concrete-Maximum | TCP: Timber-Concrete-Partial

T: $F_{1,T,Rk}$ load-carrying capacity of timber | S: $F_{1,S,Rk}$ load-carrying capacity of steel

Table B. 156 Angle bracket type 6504SA4, Variant TCP, Fastener Profiled nail A4 4x40, Density 350 kg/m³Characteristic load-carrying capacity $F_{1,Rk}$ (N) for one / two angle brackets

angle bracket	1													2	
f (mm)	0	10	20	30	40	50	60	70	80	90	100	110	120	0	
$F_{1,Rk}$	T	6560	450	225	150	113	90	75	64	56	50	45	41	38	13120
	S	57	48	41	36	32	29	26	24	21	19	17	15	14	114
k_1 (-)	9,2	11,0	12,8	14,6	16,5	18,3	20,1	21,9	23,7	25,5	27,4	29,2	31,0	4,6	

Characteristic load-carrying capacity $F_{2/3,Rk}$ (N) for one / two angle brackets

angle bracket	1	2	
$F_{2/3,Rk}$	T	1340	2680
	S	-	-

Characteristic load-carrying capacity $F_{4,Rk}$ (N) for one angle bracket

e (mm)	0	20	40	60	80	100	120	140	160	180	200	220	240	260	280	300	320
$F_{4,Rk}$	T	-	-	1286	191	103	71	54	43	36	31	28	25	22	20	18	16
	S	-	145	72	48	36	27	21	16	14	12	10	9	8	7	7	6
k_1 (-)	0,0	3,6	7,3	10,9	14,5	18,2	21,8	25,5	29,1	32,7	36,4	40,0	43,6	47,3	50,9	54,5	58,2

Characteristic load-carrying capacity $F_{5,Rk}$ (N) for one angle bracket

b / e (mm)	0	20	40	60	80	100	120	140	160	180	200	220	240	260	280	300	320
0	T	123	273	1530	1020	765	612	510	437	383	340	306	278	255	235	219	204
	S	48	106	596	397	298	238	198	170	149	132	119	108	99	91	85	79
20	T	123	273	1530	1020	765	612	510	437	383	340	306	278	255	235	219	204
	S	48	106	596	397	298	238	198	170	149	132	119	108	99	91	85	79
40	T	123	273	1530	1020	765	612	510	437	383	340	306	278	255	235	219	204
	S	48	106	596	397	298	238	198	170	149	132	119	108	99	91	85	79
60	T	123	273	1530	1020	765	612	510	437	383	340	306	278	255	235	219	204
	S	48	106	596	397	298	238	198	170	149	132	119	108	99	91	85	79
80	T	123	273	1530	1020	765	612	510	437	383	340	306	278	255	235	219	204
	S	48	106	596	397	298	238	198	170	149	132	119	108	99	91	85	79
100	T	123	273	1530	1020	765	612	510	437	383	340	306	278	255	235	219	204
	S	48	106	596	397	298	238	198	170	149	132	119	108	99	91	85	79
120	T	123	273	1530	1020	765	612	510	437	383	340	306	278	255	235	219	204
	S	48	106	596	397	298	238	198	170	149	132	119	108	99	91	85	79
140	T	123	273	1530	1020	765	612	510	437	383	340	306	278	255	235	219	204
	S	48	106	596	397	298	238	198	170	149	132	119	108	99	91	85	79
160	T	123	273	1530	1020	765	612	510	437	383	340	306	278	255	235	219	204
	S	48	106	596	397	298	238	198	170	149	132	119	108	99	91	85	79
180	T	123	273	1530	1020	765	612	510	437	383	340	306	278	255	235	219	204
	S	48	106	596	397	298	238	198	170	149	132	119	108	99	91	85	79
200	T	123	273	1530	1020	765	612	510	437	383	340	306	278	255	235	219	204
	S	48	106	596	397	298	238	198	170	149	132	119	108	99	91	85	79
220	T	123	273	1530	1020	765	612	510	437	383	340	306	278	255	235	219	204
	S	48	106	596	397	298	238	198	170	149	132	119	108	99	91	85	79
240	T	123	273	1530	1020	765	612	510	437	383	340	306	278	255	235	219	204
	S	48	106	596	397	298	238	198	170	149	132	119	108	99	91	85	79
$k_1 \times b$ (-)	0,0	16,8	33,7	50,5	67,4	84,2	101,1	117,9	134,7	151,6	168,4	185,3	202,1	218,9	235,8	252,6	269,5

Characteristic load-carrying capacity $F_{4/5,Rk}$ (N) for two angle brackets

b / e (mm)	0	20	40	60	80	100	120	140	160	180	200	220	240	260	280	300	320
0	T	7199	7199	7199	7199	7199	7199	7199	7199	7199	7199	7199	7199	7199	7199	7199	7199
	S	-	-	-	-	-	-	-	-	-	-	-	-	-	-	-	-
20	T	7199	6560	3280	2187	1640	1312	1093	937	820	729	656	596	547	505	469	437
	S	-	57	28	19	14	11	9	8	7	6	5	5	4	4	4	3
40	T	7199	7200	6560	4373	3280	2624	2187	1874	1640	1458	1312	1193	1093	1009	937	875
	S	-	115	57	38	28	23	19	16	14	12	11	10	9	8	8	7
60	T	7199	7200	7200	6560	4920	3936	3280	2811	2460	2187	1968	1789	1640	1514	1406	1312
	S	-	173	86	57	43	34	28	24	21	19	17	15	14	13	12	11
80	T	7199	7200	7200	7200	6560	5248	4373	3749	3280	2916	2624	2385	2187	2018	1874	1749
	S	-	231	115	77	57	46	38	33	28	25	23	21	19	17	16	15
100	T	7199	7200	7200	7200	7200	6560	5467	4686	4100	3644	3280	2982	2733	2523	2343	2187
	S	-	288	144	96	72	57	48	41	36	32	28	26	24	22	20	19
120	T	7199	7200	7200	7200	7200	7200	6560	5623	4920	4373	3936	3578	3280	3028	2811	2624
	S	-	346	173	115	86	69	57	49	43	38	34	31	28	26	24	23
140	T	7199	7200	7200	7200	7200	7200	6560	5740	5102	4592	4175	3827	3532	3280	3061	2870
	S	-	404	202	134	101	80	67	57	50	44	40	36	33	31	28	26
160	T	7199	7200	7200	7200	7200	7200	7200	6560	5831	5248	4771	4373	4037	3749	3499	3280
	S	-	462	231	154	115	92	77	66	57	51	46	42	38	35	33	30
180	T	7199	7200	7200	7200	7200	7200	7200	7200	6560	5904	5367	4920	4542	4217	3936	3690
	S	-	519	259	173	129	103	86	74	64	57	51	47	43	39	37	34
200	T	7199	7200	7200	7200	7200	7200	7200	7200	7200	6560	5964	5467	5046	4686	4373	4100
	S	-	577	288	192	144	115	96	82	72	64	57	52	48	44	41	38
220	T	7199	7200	7200	7200	7200	7200	7200	7200	7200	7200	6560	6013	5551	5154	4811	4510
	S	-	635	317	211	158	127	105	90	79	70	63	57	52	48	45	42
240	T	7199	7200	7200	7200	7200	7200	7200	7200	7200	7200	7200	7156	6560	6055	5623	5248
	S	-	693	346	231	173	138	115	99	86	77	69	63	57	53	49	46
$k_1 \times b$ (-)	0,0	183,6	367,3	550,9	734,5	918,2	1101,8	1285,5	1469,1	1652,7	1836,4	2020,0	2203,6	2387,3	2570,9	2754,5	2938,2

TTM: Timber-Timber-Maximum | TTP: Timber-Timber-Partial | TCM: Timber-Concrete-Maximum | TCP: Timber-Concrete-Partial

T: $F_{1,T,Rk}$ load-carrying capacity of timber | S: $F_{1,S,Rk}$ load-carrying capacity of steel

Table B. 157 Angle bracket type 6504SA4, Variant TCP, Fastener Profiled nail A4 4x60, Density 350 kg/m³Characteristic load-carrying capacity $F_{1,Rk}$ (N) for one / two angle brackets

angle bracket		1													2
f (mm)		0	10	20	30	40	50	60	70	80	90	100	110	120	0
$F_{1,Rk}$	T	7956	750	375	250	188	150	125	107	94	83	75	68	63	15912
	S	57	48	41	36	32	29	26	24	21	19	17	15	14	114
$k_1 (-)$		9,2	11,0	12,8	14,6	16,5	18,3	20,1	21,9	23,7	25,5	27,4	29,2	31,0	4,6

Characteristic load-carrying capacity $F_{2/3,Rk}$ (N) for one / two angle brackets

angle bracket		1	2
$F_{2/3,Rk}$	T	1960	3920
	S	-	-

Characteristic load-carrying capacity $F_{4,Rk}$ (N) for one angle bracket

e (mm)		0	20	40	60	80	100	120	140	160	180	200	220	240	260	280	300	320
$F_{4,Rk}$	T	-	-	2143	319	172	118	90	72	61	52	46	41	37	34	31	28	26
	S	-	145	72	48	36	27	21	16	14	12	10	9	8	7	7	6	6
$k_1 (-)$		0,0	3,6	7,3	10,9	14,5	18,2	21,8	25,5	29,1	32,7	36,4	40,0	43,6	47,3	50,9	54,5	58,2

Characteristic load-carrying capacity $F_{5,Rk}$ (N) for one angle bracket

b / e (mm)		0	20	40	60	80	100	120	140	160	180	200	220	240	260	280	300	320
0	T	205	455	2550	1700	1275	1020	850	729	638	567	510	464	425	392	364	340	319
	S	48	106	596	397	298	238	198	170	149	132	119	108	99	91	85	79	74
20	T	205	455	2550	1700	1275	1020	850	729	638	567	510	464	425	392	364	340	319
	S	48	106	596	397	298	238	198	170	149	132	119	108	99	91	85	79	74
40	T	205	455	2550	1700	1275	1020	850	729	638	567	510	464	425	392	364	340	319
	S	48	106	596	397	298	238	198	170	149	132	119	108	99	91	85	79	74
60	T	205	455	2550	1700	1275	1020	850	729	638	567	510	464	425	392	364	340	319
	S	48	106	596	397	298	238	198	170	149	132	119	108	99	91	85	79	74
80	T	205	455	2550	1700	1275	1020	850	729	638	567	510	464	425	392	364	340	319
	S	48	106	596	397	298	238	198	170	149	132	119	108	99	91	85	79	74
100	T	205	455	2550	1700	1275	1020	850	729	638	567	510	464	425	392	364	340	319
	S	48	106	596	397	298	238	198	170	149	132	119	108	99	91	85	79	74
120	T	205	455	2550	1700	1275	1020	850	729	638	567	510	464	425	392	364	340	319
	S	48	106	596	397	298	238	198	170	149	132	119	108	99	91	85	79	74
140	T	205	455	2550	1700	1275	1020	850	729	638	567	510	464	425	392	364	340	319
	S	48	106	596	397	298	238	198	170	149	132	119	108	99	91	85	79	74
160	T	205	455	2550	1700	1275	1020	850	729	638	567	510	464	425	392	364	340	319
	S	48	106	596	397	298	238	198	170	149	132	119	108	99	91	85	79	74
180	T	205	455	2550	1700	1275	1020	850	729	638	567	510	464	425	392	364	340	319
	S	48	106	596	397	298	238	198	170	149	132	119	108	99	91	85	79	74
200	T	205	455	2550	1700	1275	1020	850	729	638	567	510	464	425	392	364	340	319
	S	48	106	596	397	298	238	198	170	149	132	119	108	99	91	85	79	74
220	T	205	455	2550	1700	1275	1020	850	729	638	567	510	464	425	392	364	340	319
	S	48	106	596	397	298	238	198	170	149	132	119	108	99	91	85	79	74
240	T	205	455	2550	1700	1275	1020	850	729	638	567	510	464	425	392	364	340	319
	S	48	106	596	397	298	238	198	170	149	132	119	108	99	91	85	79	74
$k_1 \times b (-)$		0,0	16,8	33,7	50,5	67,4	84,2	101,1	117,9	134,7	151,6	168,4	185,3	202,1	218,9	235,8	252,6	269,5

Characteristic load-carrying capacity $F_{4/5,Rk}$ (N) for two angle brackets

b / e (mm)		0	20	40	60	80	100	120	140	160	180	200	220	240	260	280	300	320
0	T	12000	12000	12000	12000	12000	12000	12000	12000	12000	12000	12000	12000	12000	12000	12000	12000	12000
	S	-	-	-	-	-	-	-	-	-	-	-	-	-	-	-	-	-
20	T	12000	7956	3978	2652	1989	1591	1326	1137	995	884	796	723	663	612	568	530	497
	S	-	57	28	19	14	11	9	8	7	6	5	5	4	4	4	3	3
40	T	12000	12000	7956	5304	3978	3182	2652	2273	1989	1768	1591	1447	1326	1224	1137	1061	995
	S	-	115	57	38	28	23	19	16	14	12	11	10	9	8	8	7	7
60	T	12000	12000	11934	7956	5967	4774	3978	3410	2984	2652	2387	2170	1989	1836	1705	1591	1492
	S	-	173	86	57	43	34	28	24	21	19	17	15	14	13	12	11	10
80	T	12000	12000	12000	10608	7956	6365	5304	4546	3978	3536	3182	2893	2652	2448	2273	2122	1989
	S	-	231	115	77	57	46	38	33	28	25	23	21	19	17	16	15	14
100	T	12000	12000	12000	12000	9945	7956	6630	5683	4973	4420	3978	3616	3315	3060	2841	2652	2486
	S	-	288	144	96	72	57	48	41	36	32	28	26	24	22	20	19	18
120	T	12000	12000	12000	11934	9547	7956	6819	5967	5304	4774	4340	3978	3672	3410	3182	2984	2884
	S	-	346	173	115	86	69	57	49	43	38	34	31	28	26	24	23	21
140	T	12000	12000	12000	12000	11138	9282	7956	6962	6188	5569	5063	4641	4284	3978	3713	3481	3381
	S	-	404	202	134	101	80	67	57	50	44	40	36	33	31	28	26	25
160	T	12000	12000	12000	12000	12000	10608	9093	7956	7072	6365	5786	5304	4896	4546	4243	3978	3978
	S	-	462	231	154	115	92	77	66	57	51	46	42	38	35	33	30	28
180	T	12000	12000	12000	12000	12000	11934	10229	8951	7956	7160	6509	5967	5508	5115	4774	4475	4475
	S	-	519	259	173	129	103	86	74	64	57	51	47	43	39	37	34	32
200	T	12000	12000	12000	12000	12000	12000	11366	9945	8840	7956	7233	6630	6120	5683	5304	4973	4973
	S	-	577	288	192	144	115	96	82	72	64	57	52	48	44	41	38	36
220	T	12000	12000	12000	12000	12000	12000	12000	10940	9724	8752	7956	7293	6732	6251	5834	5470	5470
	S	-	635	317	211	158	127	105	90	79	70	63	57	52	48	45	42	39
240	T	12000	12000	12000	12000	12000	12000	12000	11934	10608	9547	8679	7956	7344	6819	6365	5967	5967
	S	-	693	346	231	173	138	115	99	86	77	69	63	57	53	49	46	43
$k_1 \times b (-)$		0,0	183,6	367,3	550,9	734,5	918,2	1101,8	1285,5	1469,1	1652,7	1836,4	2020,0	2203,6	2387,3	2570,9	2754,5	2938,2

TTM: Timber-Timber-Maximum | TTP: Timber-Timber-Partial | TCM: Timber-Concrete-Maximum | TCP: Timber-Concrete-Partial

T: $F_{1,T,Rk}$ load-carrying capacity of timber | S: $F_{1,S,Rk}$ load-carrying capacity of steel

Table B. 158 Angle bracket type 6504SA4, Variant TTM, Fastener Profiled nail A4 4x40, Density 350 kg/m³Characteristic load-carrying capacity $F_{T,Rk}$ (N) for one / two angle brackets

angle bracket		1													2
f (mm)		0	10	20	30	40	50	60	70	80	90	100	110	120	0
$F_{T,Rk}$	T	486	316	225	150	113	90	75	64	56	50	45	41	38	973
	S	201	130	87	58	43	35	29	25	21	19	17	15	14	402

Characteristic load-carrying capacity $F_{2/3,Rk}$ (N) for one / two angle brackets

angle bracket		1	2
$F_{2/3,Rk}$	T	5350	10700
	S	-	-

Characteristic load-carrying capacity $F_{4,Rk}$ (N) for one angle bracket

e (mm)		0	20	40	60	80	100	120	140	160	180	200	220	240	260	280	300	320
$F_{4,Rk}$	T	19679	450	225	150	103	71	54	43	36	31	28	25	22	20	18	17	16
	S	-	186	93	62	40	27	21	16	14	12	10	9	8	7	7	6	6

Characteristic load-carrying capacity $F_{5,Rk}$ (N) for one angle bracket

b / e (mm)		0	20	40	60	80	100	120	140	160	180	200	220	240	260	280	300	320
0	T	123	273	1440	960	720	576	480	411	360	320	288	262	240	222	206	192	180
	S	48	106	596	397	298	238	198	170	149	132	119	108	99	91	85	79	74
20	T	123	273	1530	1020	765	612	510	437	383	340	306	278	255	235	219	204	191
	S	48	106	596	397	298	238	198	170	149	132	119	108	99	91	85	79	74
40	T	123	273	1530	1020	765	612	510	437	383	340	306	278	255	235	219	204	191
	S	48	106	596	397	298	238	198	170	149	132	119	108	99	91	85	79	74
60	T	123	273	1530	1020	765	612	510	437	383	340	306	278	255	235	219	204	191
	S	48	106	596	397	298	238	198	170	149	132	119	108	99	91	85	79	74
80	T	123	273	1530	1020	765	612	510	437	383	340	306	278	255	235	219	204	191
	S	48	106	596	397	298	238	198	170	149	132	119	108	99	91	85	79	74
100	T	123	273	1530	1020	765	612	510	437	383	340	306	278	255	235	219	204	191
	S	48	106	596	397	298	238	198	170	149	132	119	108	99	91	85	79	74
120	T	123	273	1530	1020	765	612	510	437	383	340	306	278	255	235	219	204	191
	S	48	106	596	397	298	238	198	170	149	132	119	108	99	91	85	79	74
140	T	123	273	1530	1020	765	612	510	437	383	340	306	278	255	235	219	204	191
	S	48	106	596	397	298	238	198	170	149	132	119	108	99	91	85	79	74
160	T	123	273	1530	1020	765	612	510	437	383	340	306	278	255	235	219	204	191
	S	48	106	596	397	298	238	198	170	149	132	119	108	99	91	85	79	74
180	T	123	273	1530	1020	765	612	510	437	383	340	306	278	255	235	219	204	191
	S	48	106	596	397	298	238	198	170	149	132	119	108	99	91	85	79	74
200	T	123	273	1530	1020	765	612	510	437	383	340	306	278	255	235	219	204	191
	S	48	106	596	397	298	238	198	170	149	132	119	108	99	91	85	79	74
220	T	123	273	1530	1020	765	612	510	437	383	340	306	278	255	235	219	204	191
	S	48	106	596	397	298	238	198	170	149	132	119	108	99	91	85	79	74
240	T	123	273	1530	1020	765	612	510	437	383	340	306	278	255	235	219	204	191
	S	48	106	596	397	298	238	198	170	149	132	119	108	99	91	85	79	74

Characteristic load-carrying capacity $F_{4/5,Rk}$ (N) for two angle brackets

b / e (mm)		0	20	40	60	80	100	120	140	160	180	200	220	240	260	280	300	320
0	T	14400	14400	14400	14400	14400	14400	14400	14400	14400	14400	14400	14400	14400	14400	14400	14400	14400
	S	-	-	-	-	-	-	-	-	-	-	-	-	-	-	-	-	-
20	T	14400	486	243	162	122	97	81	69	61	54	49	44	41	37	35	32	30
	S	-	201	100	67	50	40	33	28	25	22	20	18	16	15	14	13	12
40	T	14400	973	486	324	243	195	162	139	122	108	97	88	81	75	69	65	61
	S	-	403	201	134	100	80	67	57	50	44	40	36	33	31	28	26	25
60	T	14400	1459	730	486	365	292	243	208	182	162	146	133	122	112	104	97	91
	S	-	604	302	201	151	120	100	86	75	67	60	54	50	46	43	40	37
80	T	14400	1946	973	649	486	389	324	278	243	216	195	177	162	150	139	130	122
	S	-	806	403	268	201	161	134	115	100	89	80	73	67	62	57	53	50
100	T	14400	2432	1216	811	608	486	405	347	304	270	243	221	203	187	174	162	152
	S	-	1007	503	335	251	201	167	143	125	111	100	91	83	77	71	67	62
120	T	14400	2919	1459	973	730	584	486	417	365	324	292	265	243	225	208	195	182
	S	-	1209	604	403	302	241	201	172	151	134	120	109	100	93	86	80	75
140	T	14400	3405	1703	1135	851	681	568	486	426	378	341	310	284	262	243	227	213
	S	-	1411	705	470	352	282	235	201	176	156	141	128	117	108	100	94	88
160	T	14400	3892	1946	1297	973	778	649	556	486	432	389	354	324	299	278	259	243
	S	-	1612	806	537	403	322	268	230	201	179	161	146	134	124	115	107	100
180	T	14400	4378	2189	1459	1095	876	730	625	547	486	438	398	365	337	313	292	274
	S	-	1814	907	604	453	362	302	259	226	201	181	164	151	139	129	120	113
200	T	14400	4865	2432	1622	1216	973	811	695	608	541	486	442	405	374	347	324	304
	S	-	2015	1007	671	503	403	335	287	251	223	201	183	167	155	143	134	125
220	T	14400	5351	2676	1784	1338	1070	892	764	669	595	535	486	446	412	382	357	334
	S	-	2217	1108	739	554	443	369	316	277	246	221	201	184	170	158	147	138
240	T	14400	5838	2919	1946	1459	1168	973	834	730	649	584	531	486	449	417	389	365
	S	-	2418	1209	806	604	483	403	345	302	268	241	219	201	186	172	161	151

TTM: Timber-Timber-Maximum | TTP: Timber-Timber-Partial | TCM: Timber-Concrete-Maximum | TCP: Timber-Concrete-Partial

T: $F_{T,Rk}$ load-carrying capacity of timber | S: $F_{S,Rk}$ load-carrying capacity of steel

Table B. 159 Angle bracket type 6504SA4, Variant TTM, Fastener Profiled nail A4 4x60, Density 350 kg/m³Characteristic load-carrying capacity $F_{1,Rk}$ (N) for one / two angle brackets

angle bracket		1													2
f (mm)		0	10	20	30	40	50	60	70	80	90	100	110	120	0
$F_{1,Rk}$	T	811	526	375	250	188	150	125	107	94	83	75	68	63	1622
	S	201	130	87	58	43	35	29	25	21	19	17	15	14	402

Characteristic load-carrying capacity $F_{2/3,Rk}$ (N) for one / two angle brackets

angle bracket		1	2
$F_{2/3,Rk}$	T	6920	13840
	S	-	-

Characteristic load-carrying capacity $F_{4,Rk}$ (N) for one angle bracket

e (mm)		0	20	40	60	80	100	120	140	160	180	200	220	240	260	280	300	320
$F_{4,Rk}$	T	23867	750	375	250	172	118	90	72	61	52	46	41	37	34	31	28	26
	S	-	186	93	62	40	27	21	16	14	12	10	9	8	7	7	6	6

Characteristic load-carrying capacity $F_{5,Rk}$ (N) for one angle bracket

b / e (mm)		0	20	40	60	80	100	120	140	160	180	200	220	240	260	280	300	320
0	T	205	455	2400	1600	1200	960	800	686	600	533	480	436	400	369	343	320	300
	S	48	106	596	397	298	238	198	170	149	132	119	108	99	91	85	79	74
20	T	205	455	2550	1700	1275	1020	850	729	638	567	510	464	425	392	364	340	319
	S	48	106	596	397	298	238	198	170	149	132	119	108	99	91	85	79	74
40	T	205	455	2550	1700	1275	1020	850	729	638	567	510	464	425	392	364	340	319
	S	48	106	596	397	298	238	198	170	149	132	119	108	99	91	85	79	74
60	T	205	455	2550	1700	1275	1020	850	729	638	567	510	464	425	392	364	340	319
	S	48	106	596	397	298	238	198	170	149	132	119	108	99	91	85	79	74
80	T	205	455	2550	1700	1275	1020	850	729	638	567	510	464	425	392	364	340	319
	S	48	106	596	397	298	238	198	170	149	132	119	108	99	91	85	79	74
100	T	205	455	2550	1700	1275	1020	850	729	638	567	510	464	425	392	364	340	319
	S	48	106	596	397	298	238	198	170	149	132	119	108	99	91	85	79	74
120	T	205	455	2550	1700	1275	1020	850	729	638	567	510	464	425	392	364	340	319
	S	48	106	596	397	298	238	198	170	149	132	119	108	99	91	85	79	74
140	T	205	455	2550	1700	1275	1020	850	729	638	567	510	464	425	392	364	340	319
	S	48	106	596	397	298	238	198	170	149	132	119	108	99	91	85	79	74
160	T	205	455	2550	1700	1275	1020	850	729	638	567	510	464	425	392	364	340	319
	S	48	106	596	397	298	238	198	170	149	132	119	108	99	91	85	79	74
180	T	205	455	2550	1700	1275	1020	850	729	638	567	510	464	425	392	364	340	319
	S	48	106	596	397	298	238	198	170	149	132	119	108	99	91	85	79	74
200	T	205	455	2550	1700	1275	1020	850	729	638	567	510	464	425	392	364	340	319
	S	48	106	596	397	298	238	198	170	149	132	119	108	99	91	85	79	74
220	T	205	455	2550	1700	1275	1020	850	729	638	567	510	464	425	392	364	340	319
	S	48	106	596	397	298	238	198	170	149	132	119	108	99	91	85	79	74
240	T	205	455	2550	1700	1275	1020	850	729	638	567	510	464	425	392	364	340	319
	S	48	106	596	397	298	238	198	170	149	132	119	108	99	91	85	79	74

Characteristic load-carrying capacity $F_{4/5,Rk}$ (N) for two angle brackets

b / e (mm)		0	20	40	60	80	100	120	140	160	180	200	220	240	260	280	300	320
0	T	23999	23999	23999	23999	23999	23999	23999	23999	23999	23999	23999	23999	23999	23999	23999	23999	23999
	S	-	-	-	-	-	-	-	-	-	-	-	-	-	-	-	-	-
20	T	23999	811	405	270	203	162	135	116	101	90	81	74	68	62	58	54	51
	S	-	201	100	67	50	40	33	28	25	22	20	18	16	15	14	13	12
40	T	23999	1622	811	541	405	324	270	232	203	180	162	147	135	125	116	108	101
	S	-	403	201	134	100	80	67	57	50	44	40	36	33	31	28	26	25
60	T	23999	2432	1216	811	608	486	405	347	304	270	243	221	203	187	174	162	152
	S	-	604	302	201	151	120	100	86	75	67	60	54	50	46	43	40	37
80	T	23999	3243	1622	1081	811	649	541	463	405	360	324	295	270	249	232	216	203
	S	-	806	403	268	201	161	134	115	100	89	80	73	67	62	57	53	50
100	T	23999	4054	2027	1351	1014	811	676	579	507	450	405	369	338	312	290	270	253
	S	-	1007	503	335	251	201	167	143	125	111	100	91	83	77	71	67	62
120	T	23999	4865	2432	1622	1216	973	811	695	608	541	486	442	405	374	347	324	304
	S	-	1209	604	403	302	241	201	172	151	134	120	109	100	93	86	80	75
140	T	23999	5676	2838	1892	1419	1135	946	811	709	631	568	516	473	437	405	378	355
	S	-	1411	705	470	352	282	235	201	176	156	141	128	117	108	100	94	88
160	T	23999	6486	3243	2162	1622	1297	1081	927	811	721	649	590	541	499	463	432	405
	S	-	1612	806	537	403	322	268	230	201	179	161	146	134	124	115	107	100
180	T	23999	7297	3649	2432	1824	1459	1216	1042	912	811	730	663	608	561	521	486	456
	S	-	1814	907	604	453	362	302	259	226	201	181	164	151	139	129	120	113
200	T	23999	8108	4054	2703	2027	1622	1351	1158	1014	901	811	737	676	624	579	541	507
	S	-	2015	1007	671	503	403	335	287	251	223	201	183	167	155	143	134	125
220	T	23999	8919	4459	2973	2230	1784	1486	1274	1115	991	892	811	743	686	637	595	557
	S	-	2217	1108	739	554	443	369	316	277	246	221	201	184	170	158	147	138
240	T	23999	9730	4865	3243	2432	1946	1622	1390	1216	1081	973	885	811	748	695	649	608
	S	-	2418	1209	806	604	483	403	345	302	268	241	219	201	186	172	161	151

TTM: Timber-Timber-Maximum | TTP: Timber-Timber-Partial | TCM: Timber-Concrete-Maximum | TCP: Timber-Concrete-Partial

T: $F_{1,T,Rk}$ load-carrying capacity of timber | S: $F_{1,S,Rk}$ load-carrying capacity of steel

Table B. 160 Angle bracket type 6504SA4, Variant TTP, Fastener Profiled nail A4 4x40, Density 350 kg/m³Characteristic load-carrying capacity $F_{T,Rk}$ (N) for one / two angle brackets

angle bracket		1													2
f (mm)		0	10	20	30	40	50	60	70	80	90	100	110	120	0
$F_{T,Rk}$	T	486	316	225	150	113	90	75	64	56	50	45	41	38	973
	S	201	130	87	58	43	35	29	25	21	19	17	15	14	402

Characteristic load-carrying capacity $F_{2/3,Rk}$ (N) for one / two angle brackets

angle bracket		1	2
$F_{2/3,Rk}$	T	3200	6400
	S	-	-

Characteristic load-carrying capacity $F_{4,Rk}$ (N) for one angle bracket

e (mm)		0	20	40	60	80	100	120	140	160	180	200	220	240	260	280	300	320
$F_{4,Rk}$	T	9840	450	225	150	103	71	54	43	36	31	28	25	22	20	18	17	16
	S	-	186	93	62	40	27	21	16	14	12	10	9	8	7	7	6	6

Characteristic load-carrying capacity $F_{5,Rk}$ (N) for one angle bracket

b / e (mm)		0	20	40	60	80	100	120	140	160	180	200	220	240	260	280	300	320
0	T	123	273	1440	960	720	576	480	411	360	320	288	262	240	222	206	192	180
	S	48	106	596	397	298	238	198	170	149	132	119	108	99	91	85	79	74
20	T	123	273	1530	1020	765	612	510	437	383	340	306	278	255	235	219	204	191
	S	48	106	596	397	298	238	198	170	149	132	119	108	99	91	85	79	74
40	T	123	273	1530	1020	765	612	510	437	383	340	306	278	255	235	219	204	191
	S	48	106	596	397	298	238	198	170	149	132	119	108	99	91	85	79	74
60	T	123	273	1530	1020	765	612	510	437	383	340	306	278	255	235	219	204	191
	S	48	106	596	397	298	238	198	170	149	132	119	108	99	91	85	79	74
80	T	123	273	1530	1020	765	612	510	437	383	340	306	278	255	235	219	204	191
	S	48	106	596	397	298	238	198	170	149	132	119	108	99	91	85	79	74
100	T	123	273	1530	1020	765	612	510	437	383	340	306	278	255	235	219	204	191
	S	48	106	596	397	298	238	198	170	149	132	119	108	99	91	85	79	74
120	T	123	273	1530	1020	765	612	510	437	383	340	306	278	255	235	219	204	191
	S	48	106	596	397	298	238	198	170	149	132	119	108	99	91	85	79	74
140	T	123	273	1530	1020	765	612	510	437	383	340	306	278	255	235	219	204	191
	S	48	106	596	397	298	238	198	170	149	132	119	108	99	91	85	79	74
160	T	123	273	1530	1020	765	612	510	437	383	340	306	278	255	235	219	204	191
	S	48	106	596	397	298	238	198	170	149	132	119	108	99	91	85	79	74
180	T	123	273	1530	1020	765	612	510	437	383	340	306	278	255	235	219	204	191
	S	48	106	596	397	298	238	198	170	149	132	119	108	99	91	85	79	74
200	T	123	273	1530	1020	765	612	510	437	383	340	306	278	255	235	219	204	191
	S	48	106	596	397	298	238	198	170	149	132	119	108	99	91	85	79	74
220	T	123	273	1530	1020	765	612	510	437	383	340	306	278	255	235	219	204	191
	S	48	106	596	397	298	238	198	170	149	132	119	108	99	91	85	79	74
240	T	123	273	1530	1020	765	612	510	437	383	340	306	278	255	235	219	204	191
	S	48	106	596	397	298	238	198	170	149	132	119	108	99	91	85	79	74

Characteristic load-carrying capacity $F_{4/5,Rk}$ (N) for two angle brackets

b / e (mm)		0	20	40	60	80	100	120	140	160	180	200	220	240	260	280	300	320
0	T	7199	7199	7199	7199	7199	7199	7199	7199	7199	7199	7199	7199	7199	7199	7199	7199	7199
	S	-	-	-	-	-	-	-	-	-	-	-	-	-	-	-	-	-
20	T	7199	486	243	162	122	97	81	69	61	54	49	44	41	37	35	32	30
	S	-	201	100	67	50	40	33	28	25	22	20	18	16	15	14	13	12
40	T	7199	973	486	324	243	195	162	139	122	108	97	88	81	75	69	65	61
	S	-	403	201	134	100	80	67	57	50	44	40	36	33	31	28	26	25
60	T	7199	1459	730	486	365	292	243	208	182	162	146	133	122	112	104	97	91
	S	-	604	302	201	151	120	100	86	75	67	60	54	50	46	43	40	37
80	T	7199	1946	973	649	486	389	324	278	243	216	195	177	162	150	139	130	122
	S	-	806	403	268	201	161	134	115	100	89	80	73	67	62	57	53	50
100	T	7199	2432	1216	811	608	486	405	347	304	270	243	221	203	187	174	162	152
	S	-	1007	503	335	251	201	167	143	125	111	100	91	83	77	71	67	62
120	T	7199	2919	1459	973	730	584	486	417	365	324	292	265	243	225	208	195	182
	S	-	1209	604	403	302	241	201	172	151	134	120	109	100	93	86	80	75
140	T	7199	3405	1703	1135	851	681	568	486	426	378	341	310	284	262	243	227	213
	S	-	1411	705	470	352	282	235	201	176	156	141	128	117	108	100	94	88
160	T	7199	3892	1946	1297	973	778	649	556	486	432	389	354	324	299	278	259	243
	S	-	1612	806	537	403	322	268	230	201	179	161	146	134	124	115	107	100
180	T	7199	4378	2189	1459	1095	876	730	625	547	486	438	398	365	337	313	292	274
	S	-	1814	907	604	453	362	302	259	226	201	181	164	151	139	129	120	113
200	T	7199	4865	2432	1622	1216	973	811	695	608	541	486	442	405	374	347	324	304
	S	-	2015	1007	671	503	403	335	287	251	223	201	183	167	155	143	134	125
220	T	7199	5351	2676	1784	1338	1070	892	764	669	595	535	486	446	412	382	357	334
	S	-	2217	1108	739	554	443	369	316	277	246	221	201	184	170	158	147	138
240	T	7199	5838	2919	1946	1459	1168	973	834	730	649	584	531	486	449	417	389	365
	S	-	2418	1209	806	604	483	403	345	302	268	241	219	201	186	172	161	151

TTM: Timber-Timber-Maximum | TTP: Timber-Timber-Partial | TCM: Timber-Concrete-Maximum | TCP: Timber-Concrete-Partial

T: $F_{T,Rk}$ load-carrying capacity of timber | S: $F_{S,Rk}$ load-carrying capacity of steel

Table B. 161 Angle bracket type 6504SA4, Variant TTP, Fastener Profiled nail A4 4x60, Density 350 kg/m³Characteristic load-carrying capacity $F_{1,Rk}$ (N) for one / two angle brackets

angle bracket		1													2
f (mm)		0	10	20	30	40	50	60	70	80	90	100	110	120	0
$F_{1,Rk}$	T	811	526	375	250	188	150	125	107	94	83	75	68	63	1622
	S	201	130	87	58	43	35	29	25	21	19	17	15	14	402

Characteristic load-carrying capacity $F_{2/3,Rk}$ (N) for one / two angle brackets

angle bracket		1	2
$F_{2/3,Rk}$	T	4140	8280
	S	-	-

Characteristic load-carrying capacity $F_{4,Rk}$ (N) for one angle bracket

e (mm)		0	20	40	60	80	100	120	140	160	180	200	220	240	260	280	300	320
$F_{4,Rk}$	T	11934	750	375	250	172	118	90	72	61	52	46	41	37	34	31	28	26
	S	-	186	93	62	40	27	21	16	14	12	10	9	8	7	7	6	6

Characteristic load-carrying capacity $F_{5,Rk}$ (N) for one angle bracket

b / e (mm)		0	20	40	60	80	100	120	140	160	180	200	220	240	260	280	300	320
0	T	205	455	2400	1600	1200	960	800	686	600	533	480	436	400	369	343	320	300
	S	48	106	596	397	298	238	198	170	149	132	119	108	99	91	85	79	74
20	T	205	455	2550	1700	1275	1020	850	729	638	567	510	464	425	392	364	340	319
	S	48	106	596	397	298	238	198	170	149	132	119	108	99	91	85	79	74
40	T	205	455	2550	1700	1275	1020	850	729	638	567	510	464	425	392	364	340	319
	S	48	106	596	397	298	238	198	170	149	132	119	108	99	91	85	79	74
60	T	205	455	2550	1700	1275	1020	850	729	638	567	510	464	425	392	364	340	319
	S	48	106	596	397	298	238	198	170	149	132	119	108	99	91	85	79	74
80	T	205	455	2550	1700	1275	1020	850	729	638	567	510	464	425	392	364	340	319
	S	48	106	596	397	298	238	198	170	149	132	119	108	99	91	85	79	74
100	T	205	455	2550	1700	1275	1020	850	729	638	567	510	464	425	392	364	340	319
	S	48	106	596	397	298	238	198	170	149	132	119	108	99	91	85	79	74
120	T	205	455	2550	1700	1275	1020	850	729	638	567	510	464	425	392	364	340	319
	S	48	106	596	397	298	238	198	170	149	132	119	108	99	91	85	79	74
140	T	205	455	2550	1700	1275	1020	850	729	638	567	510	464	425	392	364	340	319
	S	48	106	596	397	298	238	198	170	149	132	119	108	99	91	85	79	74
160	T	205	455	2550	1700	1275	1020	850	729	638	567	510	464	425	392	364	340	319
	S	48	106	596	397	298	238	198	170	149	132	119	108	99	91	85	79	74
180	T	205	455	2550	1700	1275	1020	850	729	638	567	510	464	425	392	364	340	319
	S	48	106	596	397	298	238	198	170	149	132	119	108	99	91	85	79	74
200	T	205	455	2550	1700	1275	1020	850	729	638	567	510	464	425	392	364	340	319
	S	48	106	596	397	298	238	198	170	149	132	119	108	99	91	85	79	74
220	T	205	455	2550	1700	1275	1020	850	729	638	567	510	464	425	392	364	340	319
	S	48	106	596	397	298	238	198	170	149	132	119	108	99	91	85	79	74
240	T	205	455	2550	1700	1275	1020	850	729	638	567	510	464	425	392	364	340	319
	S	48	106	596	397	298	238	198	170	149	132	119	108	99	91	85	79	74

Characteristic load-carrying capacity $F_{4/5,Rk}$ (N) for two angle brackets

b / e (mm)		0	20	40	60	80	100	120	140	160	180	200	220	240	260	280	300	320
0	T	12000	12000	12000	12000	12000	12000	12000	12000	12000	12000	12000	12000	12000	12000	12000	12000	12000
	S	-	-	-	-	-	-	-	-	-	-	-	-	-	-	-	-	-
20	T	12000	811	405	270	203	162	135	116	101	90	81	74	68	62	58	54	51
	S	-	201	100	67	50	40	33	28	25	22	20	18	16	15	14	13	12
40	T	12000	1622	811	541	405	324	270	232	203	180	162	147	135	125	116	108	101
	S	-	403	201	134	100	80	67	57	50	44	40	36	33	31	28	26	25
60	T	12000	2432	1216	811	608	486	405	347	304	270	243	221	203	187	174	162	152
	S	-	604	302	201	151	120	100	86	75	67	60	54	50	46	43	40	37
80	T	12000	3243	1622	1081	811	649	541	463	405	360	324	295	270	249	232	216	203
	S	-	806	403	268	201	161	134	115	100	89	80	73	67	62	57	53	50
100	T	12000	4054	2027	1351	1014	811	676	579	507	450	405	369	338	312	290	270	253
	S	-	1007	503	335	251	201	167	143	125	111	100	91	83	77	71	67	62
120	T	12000	4865	2432	1622	1216	973	811	695	608	541	486	442	405	374	347	324	304
	S	-	1209	604	403	302	241	201	172	151	134	120	109	100	93	86	80	75
140	T	12000	5676	2838	1892	1419	1135	946	811	709	631	568	516	473	437	405	378	355
	S	-	1411	705	470	352	282	235	201	176	156	141	128	117	108	100	94	88
160	T	12000	6486	3243	2162	1622	1297	1081	927	811	721	649	590	541	499	463	432	405
	S	-	1612	806	537	403	322	268	230	201	179	161	146	134	124	115	107	100
180	T	12000	7297	3649	2432	1824	1459	1216	1042	912	811	730	663	608	561	521	486	456
	S	-	1814	907	604	453	362	302	259	226	201	181	164	151	139	129	120	113
200	T	12000	8108	4054	2703	2027	1622	1351	1158	1014	901	811	737	676	624	579	541	507
	S	-	2015	1007	671	503	403	335	287	251	223	201	183	167	155	143	134	125
220	T	12000	8919	4459	2973	2230	1784	1486	1274	1115	991	892	811	743	686	637	595	557
	S	-	2217	1108	739	554	443	369	316	277	246	221	201	184	170	158	147	138
240	T	12000	9730	4865	3243	2432	1946	1622	1390	1216	1081	973	885	811	748	695	649	608
	S	-	2418	1209	806	604	483	403	345	302	268	241	219	201	186	172	161	151

TTM: Timber-Timber-Maximum | TTP: Timber-Timber-Partial | TCM: Timber-Concrete-Maximum | TCP: Timber-Concrete-Partial

T: $F_{1,T,Rk}$ load-carrying capacity of timber | S: $F_{1,S,Rk}$ load-carrying capacity of steel

Table B. 162 Angle bracket type 9003SA4, Variant TCM, Fastener Profiled nail A4 4x40, Density 350 kg/m³

Characteristic load-carrying capacity $F_{1,Rk}$ (N) for one / two angle brackets															
angle bracket	1													2	
f (mm)	0	10	20	30	40	50	60	70	80	90	100	110	120	0	
$F_{1,Rk}$	T	19680	7020	3510	2340	1755	1404	1170	1003	878	780	702	638	585	39360
	S	43	37	32	29	26	23	21	20	18	17	16	15	14	86
k_1 (-)	5,5	6,4	7,3	8,2	9,1	10,0	10,9	11,8	12,7	13,6	14,5	15,5	16,4	2,7	

Characteristic load-carrying capacity $F_{2/3,Rk}$ (N) for one / two angle brackets			
angle bracket	1	2	
$F_{2/3,Rk}$	T	4220	8440
	S	-	-

Characteristic load-carrying capacity $F_{4,Rk}$ (N) for one angle bracket																		
e (mm)	0	20	40	60	80	100	120	140	160	180	200	220	240	260	280	300	320	
$F_{4,Rk}$	T	-	-	-	12764	2753	1543	1072	821	665	559	482	424	378	342	311	286	264
	S	-	130	65	43	32	26	21	18	16	14	13	11	10	10	9	8	8
k_1 (-)	0,0	1,8	3,6	5,5	7,3	9,1	10,9	12,7	14,5	16,4	18,2	20,0	21,8	23,6	25,5	27,3	29,1	

Characteristic load-carrying capacity $F_{5,Rk}$ (N) for one angle bracket																		
b / e (mm)	0	20	40	60	80	100	120	140	160	180	200	220	240	260	280	300	320	
0	T	1288	2035	4841	2100	1575	1260	1050	900	788	700	630	573	525	485	450	420	394
	S	264	417	646	431	323	258	215	184	161	143	129	117	107	99	92	86	80
20	T	1288	2035	4841	2100	1575	1260	1050	900	788	700	630	573	525	485	450	420	394
	S	264	417	646	431	323	258	215	184	161	143	129	117	107	99	92	86	80
40	T	1288	2035	4841	2100	1575	1260	1050	900	788	700	630	573	525	485	450	420	394
	S	264	417	646	431	323	258	215	184	161	143	129	117	107	99	92	86	80
60	T	1288	2035	4841	2100	1575	1260	1050	900	788	700	630	573	525	485	450	420	394
	S	264	417	646	431	323	258	215	184	161	143	129	117	107	99	92	86	80
80	T	1288	2035	4841	2100	1575	1260	1050	900	788	700	630	573	525	485	450	420	394
	S	264	417	646	431	323	258	215	184	161	143	129	117	107	99	92	86	80
100	T	1288	2035	4841	2100	1575	1260	1050	900	788	700	630	573	525	485	450	420	394
	S	264	417	646	431	323	258	215	184	161	143	129	117	107	99	92	86	80
120	T	1288	2035	4841	2100	1575	1260	1050	900	788	700	630	573	525	485	450	420	394
	S	264	417	646	431	323	258	215	184	161	143	129	117	107	99	92	86	80
140	T	1288	2035	4841	2100	1575	1260	1050	900	788	700	630	573	525	485	450	420	394
	S	264	417	646	431	323	258	215	184	161	143	129	117	107	99	92	86	80
160	T	1288	2035	4841	2100	1575	1260	1050	900	788	700	630	573	525	485	450	420	394
	S	264	417	646	431	323	258	215	184	161	143	129	117	107	99	92	86	80
180	T	1288	2035	4841	2100	1575	1260	1050	900	788	700	630	573	525	485	450	420	394
	S	264	417	646	431	323	258	215	184	161	143	129	117	107	99	92	86	80
200	T	1288	2035	4841	2100	1575	1260	1050	900	788	700	630	573	525	485	450	420	394
	S	264	417	646	431	323	258	215	184	161	143	129	117	107	99	92	86	80
220	T	1288	2035	4841	2100	1575	1260	1050	900	788	700	630	573	525	485	450	420	394
	S	264	417	646	431	323	258	215	184	161	143	129	117	107	99	92	86	80
240	T	1288	2035	4841	2100	1575	1260	1050	900	788	700	630	573	525	485	450	420	394
	S	264	417	646	431	323	258	215	184	161	143	129	117	107	99	92	86	80
$k_1 \times b$ (-)	0,0	8,1	16,3	24,4	32,6	40,7	48,9	57,0	65,2	73,3	81,5	89,6	97,8	105,9	114,1	122,2	130,4	

Characteristic load-carrying capacity $F_{4/5,Rk}$ (N) for two angle brackets																		
b / e (mm)	0	20	40	60	80	100	120	140	160	180	200	220	240	260	280	300	320	
0	T	21599	21599	21599	21599	21599	21599	21599	21599	21599	21599	21599	21599	21599	21599	21599	21599	
	S	-	-	-	-	-	-	-	-	-	-	-	-	-	-	-	-	
20	T	21599	19680	9840	6560	4920	3936	3280	2811	2460	2187	1968	1789	1640	1514	1406	1312	1230
	S	-	43	21	14	10	8	7	6	5	4	4	3	3	3	3	2	2
40	T	21599	21600	19680	13120	9840	7872	6560	5623	4920	4373	3936	3578	3280	3028	2811	2624	2460
	S	-	87	43	29	21	17	14	12	10	9	8	7	7	6	6	5	5
60	T	21599	21600	21600	19680	14760	11808	9840	8434	7380	6560	5904	5367	4920	4542	4217	3936	3690
	S	-	130	65	43	32	26	21	18	16	14	13	11	10	10	9	8	8
80	T	21599	21600	21600	21600	19680	15744	13120	11246	9840	8747	7872	7156	6560	6055	5623	5248	4920
	S	-	174	87	58	43	34	29	24	21	19	17	15	14	13	12	11	10
100	T	21599	21600	21600	21600	19680	16400	14057	12300	10933	9840	8945	8200	7569	7029	6560	6150	5840
	S	-	217	108	72	54	43	36	31	27	24	21	19	18	16	15	14	13
120	T	21599	21600	21600	21600	19680	16869	14760	13120	11808	10735	9840	9083	8434	7872	7380	6960	6600
	S	-	261	130	87	65	52	43	37	32	29	26	23	21	20	18	17	16
140	T	21599	21600	21600	21600	19680	17220	15307	13776	12524	11480	10597	9840	9184	8610	8100	7680	7320
	S	-	304	152	101	76	60	50	43	38	33	30	27	25	23	21	20	19
160	T	21599	21600	21600	21600	19680	17493	15744	14313	13120	12111	11246	10496	9840	9280	8800	8400	8040
	S	-	348	174	116	87	69	58	49	43	38	34	31	29	26	24	23	21
180	T	21599	21600	21600	21600	19680	17712	16102	14760	13625	12651	11808	11070	10400	9900	9480	9120	8800
	S	-	391	195	130	97	78	65	55	48	43	39	35	32	30	27	26	24
200	T	21599	21600	21600	21600	19680	17891	16400	15138	14057	13120	12300	11580	10920	10320	9800	9360	9000
	S	-	435	217	145	108	87	72	62	54	48	43	39	36	33	31	29	27
220	T	21599	21600	21600	21600	19680	18040	16652	15463	14432	13530	12720	12000	11360	10780	10260	9800	9400
	S	-	478	239	159	119	95	79	68	59	53	47	43	39	36	34	31	29
240	T	21599	21600	21600	21600	19680	18166	16869	15744	14760	13860	13040	12300	11640	11040	10500	10000	9600
	S	-	522	261	174	130	104	87	74	65	58	52	47	43	40	37	34	32
$k_1 \times b$ (-)	0,0	109,1	218,2	327,3	436,4	545,5	654,5	763,6	872,7	981,8	1090,9	1200,0	1309,1	1418,2	1527,3	1636,4	1745,5	

TTM: Timber-Timber-Maximum | TTP: Timber-Timber-Partial | TCM: Timber-Concrete-Maximum | TCP: Timber-Concrete-Partial

T: $F_{1,T,Rk}$ load-carrying capacity of timber | S: $F_{1,S,Rk}$ load-carrying capacity of steel

Table B. 163 Angle bracket type 9003SA4, Variant TCM, Fastener Profiled nail A4 4x60, Density 350 kg/m³Characteristic load-carrying capacity $F_{T,Rk}$ (N) for one / two angle brackets

angle bracket		1													2
f (mm)		0	10	20	30	40	50	60	70	80	90	100	110	120	0
$F_{T,Rk}$	T	23868	11700	5850	3900	2925	2340	1950	1671	1463	1300	1170	1064	975	47736
	S	43	37	32	29	26	23	21	20	18	17	16	15	14	86
k_t (-)		5,5	6,4	7,3	8,2	9,1	10,0	10,9	11,8	12,7	13,6	14,5	15,5	16,4	2,7

Characteristic load-carrying capacity $F_{2/3,Rk}$ (N) for one / two angle brackets

angle bracket		1	2
$F_{2/3,Rk}$	T	5930	11860
	S	-	-

Characteristic load-carrying capacity $F_{4,Rk}$ (N) for one angle bracket

e (mm)		0	20	40	60	80	100	120	140	160	180	200	220	240	260	280	300	320
$F_{4,Rk}$	T	-	-	-	21273	4588	2571	1786	1368	1109	932	804	707	631	569	519	477	441
	S	-	130	65	43	32	26	21	18	16	14	13	11	10	10	9	8	8
k_t (-)		0,0	1,8	3,6	5,5	7,3	9,1	10,9	12,7	14,5	16,4	18,2	20,0	21,8	23,6	25,5	27,3	29,1

Characteristic load-carrying capacity $F_{5,Rk}$ (N) for one angle bracket

b / e (mm)		0	20	40	60	80	100	120	140	160	180	200	220	240	260	280	300	320
0	T	2147	3391	8069	3500	2625	2100	1750	1500	1313	1167	1050	955	875	808	750	700	656
	S	264	417	646	431	323	258	215	184	161	143	129	117	107	99	92	86	80
20	T	2147	3391	8069	3500	2625	2100	1750	1500	1313	1167	1050	955	875	808	750	700	656
	S	264	417	646	431	323	258	215	184	161	143	129	117	107	99	92	86	80
40	T	2147	3391	8069	3500	2625	2100	1750	1500	1313	1167	1050	955	875	808	750	700	656
	S	264	417	646	431	323	258	215	184	161	143	129	117	107	99	92	86	80
60	T	2147	3391	8069	3500	2625	2100	1750	1500	1313	1167	1050	955	875	808	750	700	656
	S	264	417	646	431	323	258	215	184	161	143	129	117	107	99	92	86	80
80	T	2147	3391	8069	3500	2625	2100	1750	1500	1313	1167	1050	955	875	808	750	700	656
	S	264	417	646	431	323	258	215	184	161	143	129	117	107	99	92	86	80
100	T	2147	3391	8069	3500	2625	2100	1750	1500	1313	1167	1050	955	875	808	750	700	656
	S	264	417	646	431	323	258	215	184	161	143	129	117	107	99	92	86	80
120	T	2147	3391	8069	3500	2625	2100	1750	1500	1313	1167	1050	955	875	808	750	700	656
	S	264	417	646	431	323	258	215	184	161	143	129	117	107	99	92	86	80
140	T	2147	3391	8069	3500	2625	2100	1750	1500	1313	1167	1050	955	875	808	750	700	656
	S	264	417	646	431	323	258	215	184	161	143	129	117	107	99	92	86	80
160	T	2147	3391	8069	3500	2625	2100	1750	1500	1313	1167	1050	955	875	808	750	700	656
	S	264	417	646	431	323	258	215	184	161	143	129	117	107	99	92	86	80
180	T	2147	3391	8069	3500	2625	2100	1750	1500	1313	1167	1050	955	875	808	750	700	656
	S	264	417	646	431	323	258	215	184	161	143	129	117	107	99	92	86	80
200	T	2147	3391	8069	3500	2625	2100	1750	1500	1313	1167	1050	955	875	808	750	700	656
	S	264	417	646	431	323	258	215	184	161	143	129	117	107	99	92	86	80
220	T	2147	3391	8069	3500	2625	2100	1750	1500	1313	1167	1050	955	875	808	750	700	656
	S	264	417	646	431	323	258	215	184	161	143	129	117	107	99	92	86	80
240	T	2147	3391	8069	3500	2625	2100	1750	1500	1313	1167	1050	955	875	808	750	700	656
	S	264	417	646	431	323	258	215	184	161	143	129	117	107	99	92	86	80
$k_t \times b$ (-)		0,0	8,1	16,3	24,4	32,6	40,7	48,9	57,0	65,2	73,3	81,5	89,6	97,8	105,9	114,1	122,2	130,4

Characteristic load-carrying capacity $F_{4/5,Rk}$ (N) for two angle brackets

b / e (mm)		0	20	40	60	80	100	120	140	160	180	200	220	240	260	280	300	320
0	T	35999	35999	35999	35999	35999	35999	35999	35999	35999	35999	35999	35999	35999	35999	35999	35999	35999
	S	-	-	-	-	-	-	-	-	-	-	-	-	-	-	-	-	-
20	T	35999	23868	11934	7956	5967	4774	3978	3410	2984	2652	2387	2170	1989	1836	1705	1591	1492
	S	-	43	21	14	10	8	7	6	5	4	4	3	3	3	3	2	2
40	T	35999	36000	23868	15912	11934	9547	7956	6819	5967	5304	4774	4340	3978	3672	3410	3182	2984
	S	-	87	43	29	21	17	14	12	10	9	8	7	7	6	6	5	5
60	T	35999	36000	35802	23868	17901	14321	11934	10229	8951	7956	7160	6509	5967	5508	5115	4774	4475
	S	-	130	65	43	32	26	21	18	16	14	13	11	10	10	9	8	8
80	T	35999	36000	36000	31824	23868	19094	15912	13639	11934	10608	9547	8679	7956	7344	6819	6365	5967
	S	-	174	87	58	43	34	29	24	21	19	17	15	14	13	12	11	10
100	T	35999	36000	36000	36000	29835	23868	19890	17049	14918	13260	11934	10849	9945	9180	8524	7956	7459
	S	-	217	108	72	54	43	36	31	27	24	21	19	18	16	15	14	13
120	T	35999	36000	36000	36000	35802	28642	23868	20458	17901	15912	14321	13019	11934	11016	10229	9547	8951
	S	-	261	130	87	65	52	43	37	32	29	26	23	21	20	18	17	16
140	T	35999	36000	36000	36000	36000	33415	27846	23868	20885	18564	16708	15189	13923	12852	11934	11138	10442
	S	-	304	152	101	76	60	50	43	38	33	30	27	25	23	21	20	19
160	T	35999	36000	36000	36000	36000	31824	27278	23868	21216	19094	17359	15912	14688	13639	12730	11934	
	S	-	348	174	116	87	69	58	49	43	38	34	31	29	26	24	23	21
180	T	35999	36000	36000	36000	36000	36000	35802	30687	26852	23868	21481	19528	17901	16524	15344	14321	13426
	S	-	391	195	130	97	78	65	55	48	43	39	35	32	30	27	26	24
200	T	35999	36000	36000	36000	36000	36000	36000	34097	29835	26520	23868	21698	19890	18360	17049	15912	14918
	S	-	435	217	145	108	87	72	62	54	48	43	39	36	33	31	29	27
220	T	35999	36000	36000	36000	36000	36000	36000	36000	32819	29172	26255	23868	21879	20196	18753	17503	16409
	S	-	478	239	159	119	95	79	68	59	53	47	43	39	36	34	31	29
240	T	35999	36000	36000	36000	36000	36000	36000	36000	35802	31824	28642	26038	23868	22032	20458	19094	17901
	S	-	522	261	174	130	104	87	74	65	58	52	47	43	40	37	34	32
$k_t \times b$ (-)		0,0	109,1	218,2	327,3	436,4	545,5	654,5	763,6	872,7	981,8	1090,9	1200,0	1309,1	1418,2	1527,3	1636,4	1745,5

TTM: Timber-Timber-Maximum | TTP: Timber-Timber-Partial | TCM: Timber-Concrete-Maximum | TCP: Timber-Concrete-Partial

T: $F_{T,Rk}$ load-carrying capacity of timber | S: $F_{S,Rk}$ load-carrying capacity of steel

Table B. 164 Angle bracket type 9003SA4, Variant TCP, Fastener Profiled nail A4 4x40, Density 350 kg/m³Characteristic load-carrying capacity $F_{1,Rk}$ (N) for one / two angle brackets

angle bracket		1													2
f (mm)		0	10	20	30	40	50	60	70	80	90	100	110	120	0
$F_{1,Rk}$	T	13120	7020	3510	2340	1755	1404	1170	1003	878	780	702	638	585	26240
	S	43	37	32	29	26	23	21	20	18	17	16	15	14	86
k_t (-)		5,5	6,4	7,3	8,2	9,1	10,0	10,9	11,8	12,7	13,6	14,5	15,5	16,4	2,7

Characteristic load-carrying capacity $F_{2/3,Rk}$ (N) for one / two angle brackets

angle bracket		1	2
$F_{2/3,Rk}$	T	2990	5980
	S	-	-

Characteristic load-carrying capacity $F_{4,Rk}$ (N) for one angle bracket

e (mm)		0	20	40	60	80	100	120	140	160	180	200	220	240	260	280	300	320
$F_{4,Rk}$	T	-	-	-	12764	2753	1543	1072	821	665	559	482	424	378	342	311	286	264
	S	-	130	65	43	32	26	21	18	16	14	13	11	10	10	9	8	8
k_t (-)		0,0	1,8	3,6	5,5	7,3	9,1	10,9	12,7	14,5	16,4	18,2	20,0	21,8	23,6	25,5	27,3	29,1

Characteristic load-carrying capacity $F_{5,Rk}$ (N) for one angle bracket

b / e (mm)		0	20	40	60	80	100	120	140	160	180	200	220	240	260	280	300	320
0	T	1288	2035	4841	2100	1575	1260	1050	900	788	700	630	573	525	485	450	420	394
	S	264	417	646	431	323	258	215	184	161	143	129	117	107	99	92	86	80
20	T	1288	2035	4841	2100	1575	1260	1050	900	788	700	630	573	525	485	450	420	394
	S	264	417	646	431	323	258	215	184	161	143	129	117	107	99	92	86	80
40	T	1288	2035	4841	2100	1575	1260	1050	900	788	700	630	573	525	485	450	420	394
	S	264	417	646	431	323	258	215	184	161	143	129	117	107	99	92	86	80
60	T	1288	2035	4841	2100	1575	1260	1050	900	788	700	630	573	525	485	450	420	394
	S	264	417	646	431	323	258	215	184	161	143	129	117	107	99	92	86	80
80	T	1288	2035	4841	2100	1575	1260	1050	900	788	700	630	573	525	485	450	420	394
	S	264	417	646	431	323	258	215	184	161	143	129	117	107	99	92	86	80
100	T	1288	2035	4841	2100	1575	1260	1050	900	788	700	630	573	525	485	450	420	394
	S	264	417	646	431	323	258	215	184	161	143	129	117	107	99	92	86	80
120	T	1288	2035	4841	2100	1575	1260	1050	900	788	700	630	573	525	485	450	420	394
	S	264	417	646	431	323	258	215	184	161	143	129	117	107	99	92	86	80
140	T	1288	2035	4841	2100	1575	1260	1050	900	788	700	630	573	525	485	450	420	394
	S	264	417	646	431	323	258	215	184	161	143	129	117	107	99	92	86	80
160	T	1288	2035	4841	2100	1575	1260	1050	900	788	700	630	573	525	485	450	420	394
	S	264	417	646	431	323	258	215	184	161	143	129	117	107	99	92	86	80
180	T	1288	2035	4841	2100	1575	1260	1050	900	788	700	630	573	525	485	450	420	394
	S	264	417	646	431	323	258	215	184	161	143	129	117	107	99	92	86	80
200	T	1288	2035	4841	2100	1575	1260	1050	900	788	700	630	573	525	485	450	420	394
	S	264	417	646	431	323	258	215	184	161	143	129	117	107	99	92	86	80
220	T	1288	2035	4841	2100	1575	1260	1050	900	788	700	630	573	525	485	450	420	394
	S	264	417	646	431	323	258	215	184	161	143	129	117	107	99	92	86	80
240	T	1288	2035	4841	2100	1575	1260	1050	900	788	700	630	573	525	485	450	420	394
	S	264	417	646	431	323	258	215	184	161	143	129	117	107	99	92	86	80
$k_t \times b$ (-)		0,0	8,1	16,3	24,4	32,6	40,7	48,9	57,0	65,2	73,3	81,5	89,6	97,8	105,9	114,1	122,2	130,4

Characteristic load-carrying capacity $F_{4/5,Rk}$ (N) for two angle brackets

b / e (mm)		0	20	40	60	80	100	120	140	160	180	200	220	240	260	280	300	320
0	T	14400	14400	14400	14400	14400	14400	14400	14400	14400	14400	14400	14400	14400	14400	14400	14400	14400
	S	-	-	-	-	-	-	-	-	-	-	-	-	-	-	-	-	-
20	T	14400	13120	6560	4373	3280	2624	2187	1874	1640	1458	1312	1193	1093	1009	937	875	820
	S	-	43	21	14	10	8	7	6	5	4	4	3	3	3	3	2	2
40	T	14400	14400	13120	8747	6560	5248	4373	3749	3280	2916	2624	2385	2187	2018	1874	1749	1640
	S	-	87	43	29	21	17	14	12	10	9	8	7	7	6	6	5	5
60	T	14400	14400	14400	13120	9840	7872	6560	5623	4920	4373	3936	3578	3280	3028	2811	2624	2460
	S	-	130	65	43	32	26	21	18	16	14	13	11	10	10	9	8	8
80	T	14400	14400	14400	14400	13120	10496	8747	7497	6560	5831	5248	4771	4373	4037	3749	3499	3280
	S	-	174	87	58	43	34	29	24	21	19	17	15	14	13	12	11	10
100	T	14400	14400	14400	14400	14400	13120	10933	9371	8200	7289	6560	5964	5467	5046	4686	4373	4100
	S	-	217	108	72	54	43	36	31	27	24	21	19	18	16	15	14	13
120	T	14400	14400	14400	14400	14400	13120	11246	9840	8747	7872	7156	6560	6055	5623	5248	4920	4600
	S	-	261	130	87	65	52	43	37	32	29	26	23	21	20	18	17	16
140	T	14400	14400	14400	14400	14400	14400	13120	11480	10204	9184	8349	7653	7065	6560	6123	5740	5400
	S	-	304	152	101	76	60	50	43	38	33	30	27	25	23	21	20	19
160	T	14400	14400	14400	14400	14400	14400	14400	13120	11662	10496	9542	8747	8074	7497	6997	6560	6200
	S	-	348	174	116	87	69	58	49	43	38	34	31	29	26	24	23	21
180	T	14400	14400	14400	14400	14400	14400	14400	14400	13120	11808	10735	9840	9083	8434	7872	7380	7000
	S	-	391	195	130	97	78	65	55	48	43	39	35	32	30	27	26	24
200	T	14400	14400	14400	14400	14400	14400	14400	14400	14400	13120	11927	10933	10092	9371	8747	8200	7800
	S	-	435	217	145	108	87	72	62	54	48	43	39	36	33	31	29	27
220	T	14400	14400	14400	14400	14400	14400	14400	14400	14400	14400	14400	13120	12027	11102	10309	9621	9020
	S	-	478	239	159	119	95	79	68	59	53	47	43	39	36	34	31	29
240	T	14400	14400	14400	14400	14400	14400	14400	14400	14400	14400	14400	14400	14313	13120	12111	11246	10496
	S	-	522	261	174	130	104	87	74	65	58	52	47	43	40	37	34	32
$k_t \times b$ (-)		0,0	109,1	218,2	327,3	436,4	545,5	654,5	763,6	872,7	981,8	1090,9	1200,0	1309,1	1418,2	1527,3	1636,4	1745,5

TTM: Timber-Timber-Maximum | TTP: Timber-Timber-Partial | TCM: Timber-Concrete-Maximum | TCP: Timber-Concrete-Partial

T: $F_{T,Rk}$ load-carrying capacity of timber | S: $F_{S,Rk}$ load-carrying capacity of steel

Table B. 165 Angle bracket type 9003SA4, Variant TCP, Fastener Profiled nail A4 4x60, Density 350 kg/m³Characteristic load-carrying capacity $F_{T,Rk}$ (N) for one / two angle brackets

angle bracket		1													2
f (mm)		0	10	20	30	40	50	60	70	80	90	100	110	120	0
$F_{T,Rk}$	T	15912	11700	5850	3900	2925	2340	1950	1671	1463	1300	1170	1064	975	31824
	S	43	37	32	29	26	23	21	20	18	17	16	15	14	86
k_t (-)		5,5	6,4	7,3	8,2	9,1	10,0	10,9	11,8	12,7	13,6	14,5	15,5	16,4	2,7

Characteristic load-carrying capacity $F_{2/3,Rk}$ (N) for one / two angle brackets

angle bracket		1	2
$F_{2/3,Rk}$	T	4330	8660
	S	-	-

Characteristic load-carrying capacity $F_{4,Rk}$ (N) for one angle bracket

e (mm)		0	20	40	60	80	100	120	140	160	180	200	220	240	260	280	300	320
$F_{4,Rk}$	T	-	-	-	21273	4588	2571	1786	1368	1109	932	804	707	631	569	519	477	441
	S	-	130	65	43	32	26	21	18	16	14	13	11	10	10	9	8	8
k_t (-)		0,0	1,8	3,6	5,5	7,3	9,1	10,9	12,7	14,5	16,4	18,2	20,0	21,8	23,6	25,5	27,3	29,1

Characteristic load-carrying capacity $F_{5,Rk}$ (N) for one angle bracket

b / e (mm)		0	20	40	60	80	100	120	140	160	180	200	220	240	260	280	300	320
0	T	2147	3391	8069	3500	2625	2100	1750	1500	1313	1167	1050	955	875	808	750	700	656
	S	264	417	646	431	323	258	215	184	161	143	129	117	107	99	92	86	80
20	T	2147	3391	8069	3500	2625	2100	1750	1500	1313	1167	1050	955	875	808	750	700	656
	S	264	417	646	431	323	258	215	184	161	143	129	117	107	99	92	86	80
40	T	2147	3391	8069	3500	2625	2100	1750	1500	1313	1167	1050	955	875	808	750	700	656
	S	264	417	646	431	323	258	215	184	161	143	129	117	107	99	92	86	80
60	T	2147	3391	8069	3500	2625	2100	1750	1500	1313	1167	1050	955	875	808	750	700	656
	S	264	417	646	431	323	258	215	184	161	143	129	117	107	99	92	86	80
80	T	2147	3391	8069	3500	2625	2100	1750	1500	1313	1167	1050	955	875	808	750	700	656
	S	264	417	646	431	323	258	215	184	161	143	129	117	107	99	92	86	80
100	T	2147	3391	8069	3500	2625	2100	1750	1500	1313	1167	1050	955	875	808	750	700	656
	S	264	417	646	431	323	258	215	184	161	143	129	117	107	99	92	86	80
120	T	2147	3391	8069	3500	2625	2100	1750	1500	1313	1167	1050	955	875	808	750	700	656
	S	264	417	646	431	323	258	215	184	161	143	129	117	107	99	92	86	80
140	T	2147	3391	8069	3500	2625	2100	1750	1500	1313	1167	1050	955	875	808	750	700	656
	S	264	417	646	431	323	258	215	184	161	143	129	117	107	99	92	86	80
160	T	2147	3391	8069	3500	2625	2100	1750	1500	1313	1167	1050	955	875	808	750	700	656
	S	264	417	646	431	323	258	215	184	161	143	129	117	107	99	92	86	80
180	T	2147	3391	8069	3500	2625	2100	1750	1500	1313	1167	1050	955	875	808	750	700	656
	S	264	417	646	431	323	258	215	184	161	143	129	117	107	99	92	86	80
200	T	2147	3391	8069	3500	2625	2100	1750	1500	1313	1167	1050	955	875	808	750	700	656
	S	264	417	646	431	323	258	215	184	161	143	129	117	107	99	92	86	80
220	T	2147	3391	8069	3500	2625	2100	1750	1500	1313	1167	1050	955	875	808	750	700	656
	S	264	417	646	431	323	258	215	184	161	143	129	117	107	99	92	86	80
240	T	2147	3391	8069	3500	2625	2100	1750	1500	1313	1167	1050	955	875	808	750	700	656
	S	264	417	646	431	323	258	215	184	161	143	129	117	107	99	92	86	80
$k_t \times b$ (-)		0,0	8,1	16,3	24,4	32,6	40,7	48,9	57,0	65,2	73,3	81,5	89,6	97,8	105,9	114,1	122,2	130,4

Characteristic load-carrying capacity $F_{4/5,Rk}$ (N) for two angle brackets

b / e (mm)		0	20	40	60	80	100	120	140	160	180	200	220	240	260	280	300	320
0	T	23999	23999	23999	23999	23999	23999	23999	23999	23999	23999	23999	23999	23999	23999	23999	23999	23999
	S	-	-	-	-	-	-	-	-	-	-	-	-	-	-	-	-	-
20	T	23999	15912	7956	5304	3978	3182	2652	2273	1989	1768	1591	1447	1326	1224	1137	1061	995
	S	-	43	21	14	10	8	7	6	5	4	4	3	3	3	3	2	2
40	T	23999	24000	15912	10608	7956	6365	5304	4546	3978	3536	3182	2893	2652	2448	2273	2122	1989
	S	-	87	43	29	21	17	14	12	10	9	8	7	7	6	6	5	5
60	T	23999	24000	23868	15912	11934	9547	7956	6819	5967	5304	4774	4340	3978	3672	3410	3182	2984
	S	-	130	65	43	32	26	21	18	16	14	13	11	10	10	9	8	8
80	T	23999	24000	24000	21216	15912	12730	10608	9093	7956	7072	6365	5786	5304	4896	4546	4243	3978
	S	-	174	87	58	43	34	29	24	21	19	17	15	14	13	12	11	10
100	T	23999	24000	24000	24000	19890	15912	13260	11366	9945	8840	7956	7233	6630	6120	5683	5304	4973
	S	-	217	108	72	54	43	36	31	27	24	21	19	18	16	15	14	13
120	T	23999	24000	24000	24000	23868	19094	15912	13639	11934	10608	9547	8679	7956	7344	6819	6365	5967
	S	-	261	130	87	65	52	43	37	32	29	26	23	21	20	18	17	16
140	T	23999	24000	24000	24000	24000	22277	18564	15912	13923	12376	11138	10126	9282	8568	7956	7426	6962
	S	-	304	152	101	76	60	50	43	38	33	30	27	25	23	21	20	19
160	T	23999	24000	24000	24000	24000	21216	18185	15912	14144	12730	11572	10608	9792	9093	8486	7956	
	S	-	348	174	116	87	69	58	49	43	38	34	31	29	26	24	23	21
180	T	23999	24000	24000	24000	24000	23868	20458	17901	15912	14321	13019	11934	11016	10229	9547	8951	
	S	-	391	195	130	97	78	65	55	48	43	39	35	32	30	27	26	24
200	T	23999	24000	24000	24000	24000	24000	22731	19890	17680	15912	14465	13260	12240	11366	10608	9945	
	S	-	435	217	145	108	87	72	62	54	48	43	39	36	33	31	29	27
220	T	23999	24000	24000	24000	24000	24000	24000	21879	19448	17503	15912	14586	13464	12502	11669	10940	
	S	-	478	239	159	119	95	79	68	59	53	47	43	39	36	34	31	29
240	T	23999	24000	24000	24000	24000	24000	24000	23868	21216	19094	17359	15912	14688	13639	12730	11934	
	S	-	522	261	174	130	104	87	74	65	58	52	47	43	40	37	34	32
$k_t \times b$ (-)		0,0	109,1	218,2	327,3	436,4	545,5	654,5	763,6	872,7	981,8	1090,9	1200,0	1309,1	1418,2	1527,3	1636,4	1745,5

TTM: Timber-Timber-Maximum | TTP: Timber-Timber-Partial | TCM: Timber-Concrete-Maximum | TCP: Timber-Concrete-Partial

T: $F_{T,Rk}$ load-carrying capacity of timber | S: $F_{S,Rk}$ load-carrying capacity of steel

Table B. 166 Angle bracket type 9003SA4, Variant TTM, Fastener Profiled nail A4 4x40, Density 350 kg/m³Characteristic load-carrying capacity $F_{T,Rk}$ (N) for one / two angle brackets

angle bracket		1													2
f (mm)		0	10	20	30	40	50	60	70	80	90	100	110	120	0
$F_{T,Rk}$	T	2237	1890	1636	1443	1290	1167	1065	979	878	780	702	638	585	4474
	S	442	374	323	285	255	230	210	193	179	160	144	131	120	884

Characteristic load-carrying capacity $F_{2/3,Rk}$ (N) for one / two angle brackets

angle bracket		1	2
$F_{2/3,Rk}$	T	7620	15240
	S	-	-

Characteristic load-carrying capacity $F_{4,Rk}$ (N) for one angle bracket

e (mm)		0	20	40	60	80	100	120	140	160	180	200	220	240	260	280	300	320
$F_{4,Rk}$	T	22959	6095	3048	2032	1524	1219	1016	821	665	559	482	424	378	342	311	286	264
	S	-	1206	603	402	301	241	201	168	136	114	99	87	77	70	63	58	54

Characteristic load-carrying capacity $F_{5,Rk}$ (N) for one angle bracket

b / e (mm)		0	20	40	60	80	100	120	140	160	180	200	220	240	260	280	300	320
0	T	1288	2035	3544	2100	1575	1260	1050	900	788	700	630	573	525	485	450	420	394
	S	264	417	646	431	323	258	215	184	161	143	129	117	107	99	92	86	80
20	T	1288	2035	4841	2100	1575	1260	1050	900	788	700	630	573	525	485	450	420	394
	S	264	417	646	431	323	258	215	184	161	143	129	117	107	99	92	86	80
40	T	1288	2035	4841	2100	1575	1260	1050	900	788	700	630	573	525	485	450	420	394
	S	264	417	646	431	323	258	215	184	161	143	129	117	107	99	92	86	80
60	T	1288	2035	4841	2100	1575	1260	1050	900	788	700	630	573	525	485	450	420	394
	S	264	417	646	431	323	258	215	184	161	143	129	117	107	99	92	86	80
80	T	1288	2035	4841	2100	1575	1260	1050	900	788	700	630	573	525	485	450	420	394
	S	264	417	646	431	323	258	215	184	161	143	129	117	107	99	92	86	80
100	T	1288	2035	4841	2100	1575	1260	1050	900	788	700	630	573	525	485	450	420	394
	S	264	417	646	431	323	258	215	184	161	143	129	117	107	99	92	86	80
120	T	1288	2035	4841	2100	1575	1260	1050	900	788	700	630	573	525	485	450	420	394
	S	264	417	646	431	323	258	215	184	161	143	129	117	107	99	92	86	80
140	T	1288	2035	4841	2100	1575	1260	1050	900	788	700	630	573	525	485	450	420	394
	S	264	417	646	431	323	258	215	184	161	143	129	117	107	99	92	86	80
160	T	1288	2035	4841	2100	1575	1260	1050	900	788	700	630	573	525	485	450	420	394
	S	264	417	646	431	323	258	215	184	161	143	129	117	107	99	92	86	80
180	T	1288	2035	4841	2100	1575	1260	1050	900	788	700	630	573	525	485	450	420	394
	S	264	417	646	431	323	258	215	184	161	143	129	117	107	99	92	86	80
200	T	1288	2035	4841	2100	1575	1260	1050	900	788	700	630	573	525	485	450	420	394
	S	264	417	646	431	323	258	215	184	161	143	129	117	107	99	92	86	80
220	T	1288	2035	4841	2100	1575	1260	1050	900	788	700	630	573	525	485	450	420	394
	S	264	417	646	431	323	258	215	184	161	143	129	117	107	99	92	86	80
240	T	1288	2035	4841	2100	1575	1260	1050	900	788	700	630	573	525	485	450	420	394
	S	264	417	646	431	323	258	215	184	161	143	129	117	107	99	92	86	80

Characteristic load-carrying capacity $F_{4/5,Rk}$ (N) for two angle brackets

b / e (mm)		0	20	40	60	80	100	120	140	160	180	200	220	240	260	280	300	320
0	T	21599	21599	21599	21599	21599	21599	21599	21599	21599	21599	21599	21599	21599	21599	21599	21599	21599
	S	-	-	-	-	-	-	-	-	-	-	-	-	-	-	-	-	-
20	T	21599	2237	1118	746	559	447	373	320	280	249	224	203	186	172	160	149	140
	S	-	442	221	147	110	88	73	63	55	49	44	40	36	34	31	29	27
40	T	21599	4474	2237	1491	1118	895	746	639	559	497	447	407	373	344	320	298	280
	S	-	885	442	295	221	177	147	126	110	98	88	80	73	68	63	59	55
60	T	21599	6711	3355	2237	1678	1342	1118	959	839	746	671	610	559	516	479	447	419
	S	-	1327	663	442	331	265	221	189	165	147	132	120	110	102	94	88	82
80	T	21599	8947	4474	2982	2237	1789	1491	1278	1118	994	895	813	746	688	639	596	559
	S	-	1770	885	590	442	354	295	252	221	196	177	160	147	136	126	118	110
100	T	21599	11184	5592	3728	2796	2237	1864	1598	1398	1243	1118	1017	932	860	799	746	699
	S	-	2213	1106	737	553	442	368	316	276	245	221	201	184	170	158	147	138
120	T	21599	13421	6711	4474	3355	2684	2237	1917	1678	1491	1342	1220	1118	1032	959	895	839
	S	-	2655	1327	885	663	531	442	379	331	295	265	241	221	204	189	177	165
140	T	21599	15658	7829	5219	3915	3132	2610	2237	1957	1740	1566	1423	1305	1204	1118	1044	979
	S	-	3098	1549	1032	774	619	516	442	387	344	309	281	258	238	221	206	193
160	T	21599	17895	8947	5965	4474	3579	2982	2556	2237	1988	1789	1627	1491	1377	1278	1193	1118
	S	-	3541	1770	1180	885	708	590	505	442	393	354	321	295	272	252	236	221
180	T	21599	20132	10066	6711	5033	4026	3355	2876	2516	2237	2013	1830	1678	1549	1438	1342	1258
	S	-	3983	1991	1327	995	796	663	569	497	442	398	362	331	306	284	265	248
200	T	21599	21600	11184	7456	5592	4474	3728	3196	2796	2485	2237	2034	1864	1721	1598	1491	1398
	S	-	4426	2213	1475	1106	885	737	632	553	491	442	402	368	340	316	295	276
220	T	21599	21600	12303	8202	6151	4921	4101	3515	3076	2734	2461	2237	2050	1893	1758	1640	1538
	S	-	4869	2434	1623	1217	973	811	695	608	541	486	442	405	374	347	324	304
240	T	21599	21600	13421	8947	6711	5368	4474	3835	3355	2982	2684	2440	2237	2065	1917	1789	1678
	S	-	5311	2655	1770	1327	1062	885	758	663	590	531	482	442	408	379	354	331

TTM: Timber-Timber-Maximum | TTP: Timber-Timber-Partial | TCM: Timber-Concrete-Maximum | TCP: Timber-Concrete-Partial

T: $F_{T,Rk}$ load-carrying capacity of timber | S: $F_{S,Rk}$ load-carrying capacity of steel

Table B. 167 Angle bracket type 9003SA4, Variant TTM, Fastener Profiled nail A4 4x60, Density 350 kg/m³Characteristic load-carrying capacity $F_{T,Rk}$ (N) for one / two angle brackets

angle bracket		1													2
f (mm)		0	10	20	30	40	50	60	70	80	90	100	110	120	0
$F_{T,Rk}$	T	3728	3150	2727	2405	2150	1944	1775	1632	1463	1300	1170	1064	975	7456
	S	442	374	323	285	255	230	210	193	179	160	144	131	120	884

Characteristic load-carrying capacity $F_{2/3,Rk}$ (N) for one / two angle brackets

angle bracket		1	2
$F_{2/3,Rk}$	T	9440	18880
	S	-	-

Characteristic load-carrying capacity $F_{4,Rk}$ (N) for one angle bracket

e (mm)		0	20	40	60	80	100	120	140	160	180	200	220	240	260	280	300	320
$F_{4,Rk}$	T	27845	10159	5080	3386	2540	2032	1693	1368	1109	932	804	707	631	569	519	477	441
	S	-	1206	603	402	301	241	201	168	136	114	99	87	77	70	63	58	54

Characteristic load-carrying capacity $F_{5,Rk}$ (N) for one angle bracket

b / e (mm)		0	20	40	60	80	100	120	140	160	180	200	220	240	260	280	300	320
0	T	2147	3391	5906	3500	2625	2100	1750	1500	1313	1167	1050	955	875	808	750	700	656
	S	264	417	646	431	323	258	215	184	161	143	129	117	107	99	92	86	80
20	T	2147	3391	8069	3500	2625	2100	1750	1500	1313	1167	1050	955	875	808	750	700	656
	S	264	417	646	431	323	258	215	184	161	143	129	117	107	99	92	86	80
40	T	2147	3391	8069	3500	2625	2100	1750	1500	1313	1167	1050	955	875	808	750	700	656
	S	264	417	646	431	323	258	215	184	161	143	129	117	107	99	92	86	80
60	T	2147	3391	8069	3500	2625	2100	1750	1500	1313	1167	1050	955	875	808	750	700	656
	S	264	417	646	431	323	258	215	184	161	143	129	117	107	99	92	86	80
80	T	2147	3391	8069	3500	2625	2100	1750	1500	1313	1167	1050	955	875	808	750	700	656
	S	264	417	646	431	323	258	215	184	161	143	129	117	107	99	92	86	80
100	T	2147	3391	8069	3500	2625	2100	1750	1500	1313	1167	1050	955	875	808	750	700	656
	S	264	417	646	431	323	258	215	184	161	143	129	117	107	99	92	86	80
120	T	2147	3391	8069	3500	2625	2100	1750	1500	1313	1167	1050	955	875	808	750	700	656
	S	264	417	646	431	323	258	215	184	161	143	129	117	107	99	92	86	80
140	T	2147	3391	8069	3500	2625	2100	1750	1500	1313	1167	1050	955	875	808	750	700	656
	S	264	417	646	431	323	258	215	184	161	143	129	117	107	99	92	86	80
160	T	2147	3391	8069	3500	2625	2100	1750	1500	1313	1167	1050	955	875	808	750	700	656
	S	264	417	646	431	323	258	215	184	161	143	129	117	107	99	92	86	80
180	T	2147	3391	8069	3500	2625	2100	1750	1500	1313	1167	1050	955	875	808	750	700	656
	S	264	417	646	431	323	258	215	184	161	143	129	117	107	99	92	86	80
200	T	2147	3391	8069	3500	2625	2100	1750	1500	1313	1167	1050	955	875	808	750	700	656
	S	264	417	646	431	323	258	215	184	161	143	129	117	107	99	92	86	80
220	T	2147	3391	8069	3500	2625	2100	1750	1500	1313	1167	1050	955	875	808	750	700	656
	S	264	417	646	431	323	258	215	184	161	143	129	117	107	99	92	86	80
240	T	2147	3391	8069	3500	2625	2100	1750	1500	1313	1167	1050	955	875	808	750	700	656
	S	264	417	646	431	323	258	215	184	161	143	129	117	107	99	92	86	80

Characteristic load-carrying capacity $F_{4/5,Rk}$ (N) for two angle brackets

b / e (mm)		0	20	40	60	80	100	120	140	160	180	200	220	240	260	280	300	320
0	T	35999	35999	35999	35999	35999	35999	35999	35999	35999	35999	35999	35999	35999	35999	35999	35999	35999
	S	-	-	-	-	-	-	-	-	-	-	-	-	-	-	-	-	-
20	T	35999	3728	1864	1243	932	746	621	533	466	414	373	339	311	287	266	249	233
	S	-	442	221	147	110	88	73	63	55	49	44	40	36	34	31	29	27
40	T	35999	7456	3728	2485	1864	1491	1243	1065	932	828	746	678	621	574	533	497	466
	S	-	885	442	295	221	177	147	126	110	98	88	80	73	68	63	59	55
60	T	35999	11184	5592	3728	2796	2237	1864	1598	1398	1243	1118	1017	932	860	799	746	699
	S	-	1327	663	442	331	265	221	189	165	147	132	120	110	102	94	88	82
80	T	35999	14912	7456	4971	3728	2982	2485	2130	1864	1657	1491	1356	1243	1147	1065	994	932
	S	-	1770	885	590	442	354	295	252	221	196	177	160	147	136	126	118	110
100	T	35999	18641	9320	6214	4660	3728	3107	2663	2330	2071	1864	1695	1553	1434	1331	1243	1165
	S	-	2213	1106	737	553	442	368	316	276	245	221	201	184	170	158	147	138
120	T	35999	22369	11184	7456	5592	4474	3728	3196	2796	2485	2237	2034	1864	1721	1598	1491	1398
	S	-	2655	1327	885	663	531	442	379	331	295	265	241	221	204	189	177	165
140	T	35999	26097	13048	8699	6524	5219	4349	3728	3262	2900	2610	2372	2175	2007	1864	1740	1631
	S	-	3098	1549	1032	774	619	516	442	387	344	309	281	258	238	221	206	193
160	T	35999	29825	14912	9942	7456	5965	4971	4261	3728	3314	2982	2711	2485	2294	2130	1988	1864
	S	-	3541	1770	1180	885	708	590	505	442	393	354	321	295	272	252	236	221
180	T	35999	33553	16776	11184	8388	6711	5592	4793	4194	3728	3355	3050	2796	2581	2397	2237	2097
	S	-	3983	1991	1327	995	796	663	569	497	442	398	362	331	306	284	265	248
200	T	35999	36000	18641	12427	9320	7456	6214	5326	4660	4142	3728	3389	3107	2868	2663	2485	2330
	S	-	4426	2213	1475	1106	885	737	632	553	491	442	402	368	340	316	295	276
220	T	35999	36000	20505	13670	10252	8202	6835	5858	5126	4557	4101	3728	3417	3155	2929	2734	2563
	S	-	4869	2434	1623	1217	973	811	695	608	541	486	442	405	374	347	324	304
240	T	35999	36000	22369	14912	11184	8947	7456	6391	5592	4971	4474	4067	3728	3441	3196	2982	2796
	S	-	5311	2655	1770	1327	1062	885	758	663	590	531	482	442	408	379	354	331

TTM: Timber-Timber-Maximum | TTP: Timber-Timber-Partial | TCM: Timber-Concrete-Maximum | TCP: Timber-Concrete-Partial

T: $F_{T,Rk}$ load-carrying capacity of timber | S: $F_{S,Rk}$ load-carrying capacity of steel

Table B. 168 Angle bracket type 9003SA4, Variant TTP, Fastener Profiled nail A4 4x40, Density 350 kg/m³Characteristic load-carrying capacity $F_{T,Rk}$ (N) for one / two angle brackets

angle bracket		1													2
f (mm)		0	10	20	30	40	50	60	70	80	90	100	110	120	0
$F_{T,Rk}$	T	1729	1461	1265	1115	997	902	823	757	701	652	610	573	540	3459
	S	551	466	403	355	318	287	240	205	180	160	144	131	120	1102

Characteristic load-carrying capacity $F_{2/3,Rk}$ (N) for one / two angle brackets

angle bracket		1	2
$F_{2/3,Rk}$	T	4690	9380
	S	-	-

Characteristic load-carrying capacity $F_{4,Rk}$ (N) for one angle bracket

e (mm)		0	20	40	60	80	100	120	140	160	180	200	220	240	260	280	300	320
$F_{4,Rk}$	T	9840	4713	2356	1571	1178	943	785	673	589	524	471	424	378	342	311	286	264
	S	-	1293	646	431	323	258	215	168	136	114	99	87	77	70	63	58	54

Characteristic load-carrying capacity $F_{5,Rk}$ (N) for one angle bracket

b / e (mm)		0	20	40	60	80	100	120	140	160	180	200	220	240	260	280	300	320
0	T	1288	2035	1969	1313	984	788	656	563	492	438	394	358	328	303	281	263	246
	S	264	417	646	431	323	258	215	184	161	143	129	117	107	99	92	86	80
20	T	1288	2035	3626	2100	1575	1260	1050	900	788	700	630	573	525	485	450	420	394
	S	264	417	646	431	323	258	215	184	161	143	129	117	107	99	92	86	80
40	T	1288	2035	4841	2100	1575	1260	1050	900	788	700	630	573	525	485	450	420	394
	S	264	417	646	431	323	258	215	184	161	143	129	117	107	99	92	86	80
60	T	1288	2035	4841	2100	1575	1260	1050	900	788	700	630	573	525	485	450	420	394
	S	264	417	646	431	323	258	215	184	161	143	129	117	107	99	92	86	80
80	T	1288	2035	4841	2100	1575	1260	1050	900	788	700	630	573	525	485	450	420	394
	S	264	417	646	431	323	258	215	184	161	143	129	117	107	99	92	86	80
100	T	1288	2035	4841	2100	1575	1260	1050	900	788	700	630	573	525	485	450	420	394
	S	264	417	646	431	323	258	215	184	161	143	129	117	107	99	92	86	80
120	T	1288	2035	4841	2100	1575	1260	1050	900	788	700	630	573	525	485	450	420	394
	S	264	417	646	431	323	258	215	184	161	143	129	117	107	99	92	86	80
140	T	1288	2035	4841	2100	1575	1260	1050	900	788	700	630	573	525	485	450	420	394
	S	264	417	646	431	323	258	215	184	161	143	129	117	107	99	92	86	80
160	T	1288	2035	4841	2100	1575	1260	1050	900	788	700	630	573	525	485	450	420	394
	S	264	417	646	431	323	258	215	184	161	143	129	117	107	99	92	86	80
180	T	1288	2035	4841	2100	1575	1260	1050	900	788	700	630	573	525	485	450	420	394
	S	264	417	646	431	323	258	215	184	161	143	129	117	107	99	92	86	80
200	T	1288	2035	4841	2100	1575	1260	1050	900	788	700	630	573	525	485	450	420	394
	S	264	417	646	431	323	258	215	184	161	143	129	117	107	99	92	86	80
220	T	1288	2035	4841	2100	1575	1260	1050	900	788	700	630	573	525	485	450	420	394
	S	264	417	646	431	323	258	215	184	161	143	129	117	107	99	92	86	80
240	T	1288	2035	4841	2100	1575	1260	1050	900	788	700	630	573	525	485	450	420	394
	S	264	417	646	431	323	258	215	184	161	143	129	117	107	99	92	86	80

Characteristic load-carrying capacity $F_{4/5,Rk}$ (N) for two angle brackets

b / e (mm)		0	20	40	60	80	100	120	140	160	180	200	220	240	260	280	300	320
0	T	14400	14400	14400	14400	14400	14400	14400	14400	14400	14400	14400	14400	14400	14400	14400	14400	14400
	S	-	-	-	-	-	-	-	-	-	-	-	-	-	-	-	-	-
20	T	14400	1729	865	576	432	346	288	247	216	192	173	157	144	133	124	115	108
	S	-	551	275	183	137	110	91	78	68	61	55	50	45	42	39	36	34
40	T	14400	3459	1729	1153	865	692	576	494	432	384	346	314	288	266	247	231	216
	S	-	1103	551	367	275	220	183	157	137	122	110	100	91	84	78	73	68
60	T	14400	5188	2594	1729	1297	1038	865	741	649	576	519	472	432	399	371	346	324
	S	-	1654	827	551	413	330	275	236	206	183	165	150	137	127	118	110	103
80	T	14400	6918	3459	2306	1729	1384	1153	988	865	769	692	629	576	532	494	461	432
	S	-	2206	1103	735	551	441	367	315	275	245	220	200	183	169	157	147	137
100	T	14400	8647	4324	2882	2162	1729	1441	1235	1081	961	865	786	721	665	618	576	540
	S	-	2758	1379	919	689	551	459	394	344	306	275	250	229	212	197	183	172
120	T	14400	10377	5188	3459	2594	2075	1729	1482	1297	1153	1038	943	865	798	741	692	649
	S	-	3309	1654	1103	827	661	551	472	413	367	330	300	275	254	236	220	206
140	T	14400	12106	6053	4035	3027	2421	2018	1729	1513	1345	1211	1101	1009	931	865	807	757
	S	-	3861	1930	1287	965	772	643	551	482	429	386	351	321	297	275	257	241
160	T	14400	13836	6918	4612	3459	2767	2306	1977	1729	1537	1384	1258	1153	1064	988	922	865
	S	-	4412	2206	1470	1103	882	735	630	551	490	441	401	367	339	315	294	275
180	T	14400	14400	7782	5188	3891	3113	2594	2224	1946	1729	1556	1415	1297	1197	1112	1038	973
	S	-	4964	2482	1654	1241	992	827	709	620	551	496	451	413	381	354	330	310
200	T	14400	14400	8647	5765	4324	3459	2882	2471	2162	1922	1729	1572	1441	1330	1235	1153	1081
	S	-	5516	2758	1838	1379	1103	919	788	689	612	551	501	459	424	394	367	344
220	T	14400	14400	9512	6341	4756	3805	3171	2718	2378	2114	1902	1729	1585	1463	1359	1268	1189
	S	-	6067	3033	2022	1516	1213	1011	866	758	674	606	551	505	466	433	404	379
240	T	14400	14400	10377	6918	5188	4151	3459	2965	2594	2306	2075	1887	1729	1596	1482	1384	1297
	S	-	6619	3309	2206	1654	1323	1103	945	827	735	661	601	551	509	472	441	413

TTM: Timber-Timber-Maximum | TTP: Timber-Timber-Partial | TCM: Timber-Concrete-Maximum | TCP: Timber-Concrete-Partial

T: $F_{T,Rk}$ load-carrying capacity of timber | S: $F_{S,Rk}$ load-carrying capacity of steel

Table B. 169 Angle bracket type 9003SA4, Variant TTP, Fastener Profiled nail A4 4x60, Density 350 kg/m³Characteristic load-carrying capacity $F_{T,Rk}$ (N) for one / two angle brackets

angle bracket		1												2	
f (mm)		0	10	20	30	40	50	60	70	80	90	100	110	120	0
$F_{T,Rk}$	T	2882	2436	2109	1859	1662	1503	1372	1262	1168	1087	1017	955	900	5765
	S	551	466	403	355	318	287	240	205	180	160	144	131	120	1102

Characteristic load-carrying capacity $F_{2/3,Rk}$ (N) for one / two angle brackets

angle bracket		1	2
$F_{2/3,Rk}$	T	5690	11380
	S	-	-

Characteristic load-carrying capacity $F_{4,Rk}$ (N) for one angle bracket

e (mm)		0	20	40	60	80	100	120	140	160	180	200	220	240	260	280	300	320
$F_{4,Rk}$	T	11934	7855	3927	2618	1964	1571	1309	1122	982	873	785	707	631	569	519	477	441
	S	-	1293	646	431	323	258	215	168	136	114	99	87	77	70	63	58	54

Characteristic load-carrying capacity $F_{5,Rk}$ (N) for one angle bracket

b / e (mm)		0	20	40	60	80	100	120	140	160	180	200	220	240	260	280	300	320
0	T	2147	3391	3281	2188	1641	1313	1094	938	820	729	656	597	547	505	469	438	410
	S	264	417	646	431	323	258	215	184	161	143	129	117	107	99	92	86	80
20	T	2147	3391	6043	3500	2625	2100	1750	1500	1313	1167	1050	955	875	808	750	700	656
	S	264	417	646	431	323	258	215	184	161	143	129	117	107	99	92	86	80
40	T	2147	3391	8069	3500	2625	2100	1750	1500	1313	1167	1050	955	875	808	750	700	656
	S	264	417	646	431	323	258	215	184	161	143	129	117	107	99	92	86	80
60	T	2147	3391	8069	3500	2625	2100	1750	1500	1313	1167	1050	955	875	808	750	700	656
	S	264	417	646	431	323	258	215	184	161	143	129	117	107	99	92	86	80
80	T	2147	3391	8069	3500	2625	2100	1750	1500	1313	1167	1050	955	875	808	750	700	656
	S	264	417	646	431	323	258	215	184	161	143	129	117	107	99	92	86	80
100	T	2147	3391	8069	3500	2625	2100	1750	1500	1313	1167	1050	955	875	808	750	700	656
	S	264	417	646	431	323	258	215	184	161	143	129	117	107	99	92	86	80
120	T	2147	3391	8069	3500	2625	2100	1750	1500	1313	1167	1050	955	875	808	750	700	656
	S	264	417	646	431	323	258	215	184	161	143	129	117	107	99	92	86	80
140	T	2147	3391	8069	3500	2625	2100	1750	1500	1313	1167	1050	955	875	808	750	700	656
	S	264	417	646	431	323	258	215	184	161	143	129	117	107	99	92	86	80
160	T	2147	3391	8069	3500	2625	2100	1750	1500	1313	1167	1050	955	875	808	750	700	656
	S	264	417	646	431	323	258	215	184	161	143	129	117	107	99	92	86	80
180	T	2147	3391	8069	3500	2625	2100	1750	1500	1313	1167	1050	955	875	808	750	700	656
	S	264	417	646	431	323	258	215	184	161	143	129	117	107	99	92	86	80
200	T	2147	3391	8069	3500	2625	2100	1750	1500	1313	1167	1050	955	875	808	750	700	656
	S	264	417	646	431	323	258	215	184	161	143	129	117	107	99	92	86	80
220	T	2147	3391	8069	3500	2625	2100	1750	1500	1313	1167	1050	955	875	808	750	700	656
	S	264	417	646	431	323	258	215	184	161	143	129	117	107	99	92	86	80
240	T	2147	3391	8069	3500	2625	2100	1750	1500	1313	1167	1050	955	875	808	750	700	656
	S	264	417	646	431	323	258	215	184	161	143	129	117	107	99	92	86	80

Characteristic load-carrying capacity $F_{4/5,Rk}$ (N) for two angle brackets

b / e (mm)		0	20	40	60	80	100	120	140	160	180	200	220	240	260	280	300	320
0	T	23867	23867	23867	23867	23867	23867	23867	23867	23867	23867	23867	23867	23867	23867	23867	23867	23867
	S	-	-	-	-	-	-	-	-	-	-	-	-	-	-	-	-	-
20	T	23867	2882	1441	961	721	576	480	412	360	320	288	262	240	222	206	192	180
	S	-	551	275	183	137	110	91	78	68	61	55	50	45	42	39	36	34
40	T	23867	5765	2882	1922	1441	1153	961	824	721	641	576	524	480	443	412	384	360
	S	-	1103	551	367	275	220	183	157	137	122	110	100	91	84	78	73	68
60	T	23867	8647	4324	2882	2162	1729	1441	1235	1081	961	865	786	721	665	618	576	540
	S	-	1654	827	551	413	330	275	236	206	183	165	150	137	127	118	110	103
80	T	23867	11530	5765	3843	2882	2306	1922	1647	1441	1281	1153	1048	961	887	824	769	721
	S	-	2206	1103	735	551	441	367	315	275	245	220	200	183	169	157	147	137
100	T	23867	14412	7206	4804	3603	2882	2402	2059	1802	1601	1441	1310	1201	1109	1029	961	901
	S	-	2758	1379	919	689	551	459	394	344	306	275	250	229	212	197	183	172
120	T	23867	17294	8647	5765	4324	3459	2882	2471	2162	1922	1729	1572	1441	1330	1235	1153	1081
	S	-	3309	1654	1103	827	661	551	472	413	367	330	300	275	254	236	220	206
140	T	23867	20177	10088	6726	5044	4035	3363	2882	2522	2242	2018	1834	1681	1552	1441	1345	1261
	S	-	3861	1930	1287	965	772	643	551	482	429	386	351	321	297	275	257	241
160	T	23867	23059	11530	7686	5765	4612	3843	3294	2882	2562	2306	2096	1922	1774	1647	1537	1441
	S	-	4412	2206	1470	1103	882	735	630	551	490	441	401	367	339	315	294	275
180	T	23867	23868	12971	8647	6485	5188	4324	3706	3243	2882	2594	2358	2162	1996	1853	1729	1621
	S	-	4964	2482	1654	1241	992	827	709	620	551	496	451	413	381	354	330	310
200	T	23867	23868	14412	9608	7206	5765	4804	4118	3603	3203	2882	2620	2402	2217	2059	1922	1802
	S	-	5516	2758	1838	1379	1103	919	788	689	612	551	501	459	424	394	367	344
220	T	23867	23868	15853	10569	7927	6341	5284	4529	3963	3523	3171	2882	2642	2439	2265	2114	1982
	S	-	6067	3033	2022	1516	1213	1011	866	758	674	606	551	505	466	433	404	379
240	T	23867	23868	17294	11530	8647	6918	5765	4941	4324	3843	3459	3144	2882	2661	2471	2306	2162
	S	-	6619	3309	2206	1654	1323	1103	945	827	735	661	601	551	509	472	441	413

TTM: Timber-Timber-Maximum | TTP: Timber-Timber-Partial | TCM: Timber-Concrete-Maximum | TCP: Timber-Concrete-Partial

T: $F_{T,Rk}$ load-carrying capacity of timber | S: $F_{S,Rk}$ load-carrying capacity of steel

Table B. 170 Angle bracket type 9004SA4, Variant TCM, Fastener Profiled nail A4 4x40, Density 350 kg/m³Characteristic load-carrying capacity $F_{1,Rk}$ (N) for one / two angle brackets

angle bracket		1												2	
f (mm)		0	10	20	30	40	50	60	70	80	90	100	110	120	0
$F_{1,Rk}$	T	19680	900	450	300	225	180	150	129	113	100	90	82	75	39360
	S	231	173	110	73	55	44	36	31	27	24	22	20	18	
k_t (-)		5,5	7,3	9,1	10,9	12,7	14,5	16,4	18,2	20,0	21,8	23,6	25,5	27,3	2,7

Characteristic load-carrying capacity $F_{2/3,Rk}$ (N) for one / two angle brackets

angle bracket		1	2
$F_{2/3,Rk}$	T	4270	8540
	S	-	-

Characteristic load-carrying capacity $F_{4,Rk}$ (N) for one angle bracket

e (mm)		0	20	40	60	80	100	120	140	160	180	200	220	240	260	280	300	320
$F_{4,Rk}$	T	-	-	3600	400	212	144	109	88	73	63	55	49	44	40	37	34	32
	S	-	347	173	98	51	35	26	21	18	15	13	12	10	9	9	8	7
k_t (-)		0,0	3,6	7,3	10,9	14,5	18,2	21,8	25,5	29,1	32,7	36,4	40,0	43,6	47,3	50,9	54,5	58,2

Characteristic load-carrying capacity $F_{5,Rk}$ (N) for one angle bracket

b / e (mm)		0	20	40	60	80	100	120	140	160	180	200	220	240	260	280	300	320
0	T	240	514	3150	2100	1575	1260	1050	900	788	700	630	573	525	485	450	420	394
	S	58	126	773	515	386	309	257	220	193	171	154	140	128	118	110	103	96
20	T	240	514	3150	2100	1575	1260	1050	900	788	700	630	573	525	485	450	420	394
	S	58	126	773	515	386	309	257	220	193	171	154	140	128	118	110	103	96
40	T	240	514	3150	2100	1575	1260	1050	900	788	700	630	573	525	485	450	420	394
	S	58	126	773	515	386	309	257	220	193	171	154	140	128	118	110	103	96
60	T	240	514	3150	2100	1575	1260	1050	900	788	700	630	573	525	485	450	420	394
	S	58	126	773	515	386	309	257	220	193	171	154	140	128	118	110	103	96
80	T	240	514	3150	2100	1575	1260	1050	900	788	700	630	573	525	485	450	420	394
	S	58	126	773	515	386	309	257	220	193	171	154	140	128	118	110	103	96
100	T	240	514	3150	2100	1575	1260	1050	900	788	700	630	573	525	485	450	420	394
	S	58	126	773	515	386	309	257	220	193	171	154	140	128	118	110	103	96
120	T	240	514	3150	2100	1575	1260	1050	900	788	700	630	573	525	485	450	420	394
	S	58	126	773	515	386	309	257	220	193	171	154	140	128	118	110	103	96
140	T	240	514	3150	2100	1575	1260	1050	900	788	700	630	573	525	485	450	420	394
	S	58	126	773	515	386	309	257	220	193	171	154	140	128	118	110	103	96
160	T	240	514	3150	2100	1575	1260	1050	900	788	700	630	573	525	485	450	420	394
	S	58	126	773	515	386	309	257	220	193	171	154	140	128	118	110	103	96
180	T	240	514	3150	2100	1575	1260	1050	900	788	700	630	573	525	485	450	420	394
	S	58	126	773	515	386	309	257	220	193	171	154	140	128	118	110	103	96
200	T	240	514	3150	2100	1575	1260	1050	900	788	700	630	573	525	485	450	420	394
	S	58	126	773	515	386	309	257	220	193	171	154	140	128	118	110	103	96
220	T	240	514	3150	2100	1575	1260	1050	900	788	700	630	573	525	485	450	420	394
	S	58	126	773	515	386	309	257	220	193	171	154	140	128	118	110	103	96
240	T	240	514	3150	2100	1575	1260	1050	900	788	700	630	573	525	485	450	420	394
	S	58	126	773	515	386	309	257	220	193	171	154	140	128	118	110	103	96
$k_x \times b$ (-)		0,0	18,1	36,3	54,4	72,6	90,7	108,9	127,0	145,2	163,3	181,5	199,6	217,8	235,9	254,1	272,2	290,4

Characteristic load-carrying capacity $F_{4/5,Rk}$ (N) for two angle brackets

b / e (mm)		0	20	40	60	80	100	120	140	160	180	200	220	240	260	280	300	320
0	T	21599	21599	21599	21599	21599	21599	21599	21599	21599	21599	21599	21599	21599	21599	21599	21599	21599
	S	-	-	-	-	-	-	-	-	-	-	-	-	-	-	-	-	-
20	T	21599	19680	9840	6560	4920	3936	3280	2811	2460	2187	1968	1789	1640	1514	1406	1312	1230
	S	-	231	115	77	57	46	38	33	28	25	23	21	19	17	16	15	14
40	T	21599	21600	19680	13120	9840	7872	6560	5623	4920	4373	3936	3578	3280	3028	2811	2624	2460
	S	-	463	231	154	115	92	77	66	57	51	46	42	38	35	33	30	28
60	T	21599	21600	21600	19680	14760	11808	9840	8434	7380	6560	5904	5367	4920	4542	4217	3936	3690
	S	-	694	347	231	173	138	115	99	86	77	69	63	57	53	49	46	43
80	T	21599	21600	21600	21600	19680	15744	13120	11246	9840	8747	7872	7156	6560	6055	5623	5248	4920
	S	-	926	463	308	231	185	154	132	115	102	92	84	77	71	66	61	57
100	T	21599	21600	21600	21600	21600	19680	16400	14057	12300	10933	9840	8945	8200	7569	7029	6560	6150
	S	-	1157	578	385	289	231	192	165	144	128	115	105	96	89	82	77	72
120	T	21599	21600	21600	21600	21600	19680	16869	14760	13120	11808	10735	9840	9083	8434	7872	7380	6980
	S	-	1389	694	463	347	277	231	198	173	154	138	126	115	106	99	92	86
140	T	21599	21600	21600	21600	21600	19680	17220	15307	13776	12524	11480	10597	9840	9184	8610	8100	7700
	S	-	1620	810	540	405	324	270	231	202	180	162	147	135	124	115	108	101
160	T	21599	21600	21600	21600	21600	19680	17493	15744	14313	13120	12111	11246	10496	9840	9280	8780	8380
	S	-	1852	926	617	463	370	308	264	231	205	185	168	154	142	132	123	115
180	T	21599	21600	21600	21600	21600	19680	17712	16102	14760	13625	12651	11808	11070	10350	9730	9180	8730
	S	-	2083	1041	694	520	416	347	297	260	231	208	189	173	160	148	138	130
200	T	21599	21600	21600	21600	21600	19680	17891	16400	15138	14057	13120	12280	11480	10735	10080	9480	9030
	S	-	2315	1157	771	578	463	385	330	289	257	231	210	192	178	165	154	144
220	T	21599	21600	21600	21600	21600	19680	18040	16652	15463	14432	13530	12730	11980	11280	10630	10030	9530
	S	-	2546	1273	848	636	509	424	363	318	282	254	231	212	195	181	169	159
240	T	21599	21600	21600	21600	21600	19680	18166	16869	15744	14760	13869	13069	12319	11619	10969	10369	9869
	S	-	2778	1389	926	694	555	463	396	347	308	277	252	231	213	198	185	173
$k_x \times b$ (-)		0,0	109,1	218,2	327,3	436,4	545,5	654,5	763,6	872,7	981,8	1090,9	1200,0	1309,1	1418,2	1527,3	1636,4	1745,5

TTM: Timber-Timber-Maximum | TTP: Timber-Timber-Partial | TCM: Timber-Concrete-Maximum | TCP: Timber-Concrete-Partial

T: $F_{1,T,Rk}$ load-carrying capacity of timber | S: $F_{1,S,Rk}$ load-carrying capacity of steel

Table B. 171 Angle bracket type 9004SA4, Variant TCM, Fastener Profiled nail A4 4x60, Density 350 kg/m³Characteristic load-carrying capacity $F_{1,Rk}$ (N) for one / two angle brackets

angle bracket		1													2
f (mm)		0	10	20	30	40	50	60	70	80	90	100	110	120	0
$F_{1,Rk}$	T	23868	1500	750	500	375	300	250	214	188	167	150	136	125	47736
	S	231	173	110	73	55	44	36	31	27	24	22	20	18	
k_1 (-)		5,5	7,3	9,1	10,9	12,7	14,5	16,4	18,2	20,0	21,8	23,6	25,5	27,3	2,7

Characteristic load-carrying capacity $F_{2/3,Rk}$ (N) for one / two angle brackets

angle bracket		1	2
$F_{2/3,Rk}$	T	5970	11940
	S	-	-

Characteristic load-carrying capacity $F_{4,Rk}$ (N) for one angle bracket

e (mm)		0	20	40	60	80	100	120	140	160	180	200	220	240	260	280	300	320
$F_{4,Rk}$	T	-	-	6000	667	353	240	182	146	122	105	92	82	74	67	62	57	53
	S	-	347	173	98	51	35	26	21	18	15	13	12	10	9	9	8	7
k_1 (-)		0,0	3,6	7,3	10,9	14,5	18,2	21,8	25,5	29,1	32,7	36,4	40,0	43,6	47,3	50,9	54,5	58,2

Characteristic load-carrying capacity $F_{5,Rk}$ (N) for one angle bracket

b / e (mm)		0	20	40	60	80	100	120	140	160	180	200	220	240	260	280	300	320
0	T	400	857	5250	3500	2625	2100	1750	1500	1313	1167	1050	955	875	808	750	700	656
	S	58	126	773	515	386	309	257	220	193	171	154	140	128	118	110	103	96
20	T	400	857	5250	3500	2625	2100	1750	1500	1313	1167	1050	955	875	808	750	700	656
	S	58	126	773	515	386	309	257	220	193	171	154	140	128	118	110	103	96
40	T	400	857	5250	3500	2625	2100	1750	1500	1313	1167	1050	955	875	808	750	700	656
	S	58	126	773	515	386	309	257	220	193	171	154	140	128	118	110	103	96
60	T	400	857	5250	3500	2625	2100	1750	1500	1313	1167	1050	955	875	808	750	700	656
	S	58	126	773	515	386	309	257	220	193	171	154	140	128	118	110	103	96
80	T	400	857	5250	3500	2625	2100	1750	1500	1313	1167	1050	955	875	808	750	700	656
	S	58	126	773	515	386	309	257	220	193	171	154	140	128	118	110	103	96
100	T	400	857	5250	3500	2625	2100	1750	1500	1313	1167	1050	955	875	808	750	700	656
	S	58	126	773	515	386	309	257	220	193	171	154	140	128	118	110	103	96
120	T	400	857	5250	3500	2625	2100	1750	1500	1313	1167	1050	955	875	808	750	700	656
	S	58	126	773	515	386	309	257	220	193	171	154	140	128	118	110	103	96
140	T	400	857	5250	3500	2625	2100	1750	1500	1313	1167	1050	955	875	808	750	700	656
	S	58	126	773	515	386	309	257	220	193	171	154	140	128	118	110	103	96
160	T	400	857	5250	3500	2625	2100	1750	1500	1313	1167	1050	955	875	808	750	700	656
	S	58	126	773	515	386	309	257	220	193	171	154	140	128	118	110	103	96
180	T	400	857	5250	3500	2625	2100	1750	1500	1313	1167	1050	955	875	808	750	700	656
	S	58	126	773	515	386	309	257	220	193	171	154	140	128	118	110	103	96
200	T	400	857	5250	3500	2625	2100	1750	1500	1313	1167	1050	955	875	808	750	700	656
	S	58	126	773	515	386	309	257	220	193	171	154	140	128	118	110	103	96
220	T	400	857	5250	3500	2625	2100	1750	1500	1313	1167	1050	955	875	808	750	700	656
	S	58	126	773	515	386	309	257	220	193	171	154	140	128	118	110	103	96
240	T	400	857	5250	3500	2625	2100	1750	1500	1313	1167	1050	955	875	808	750	700	656
	S	58	126	773	515	386	309	257	220	193	171	154	140	128	118	110	103	96
$k_1 \times b$ (-)		0,0	18,1	36,3	54,4	72,6	90,7	108,9	127,0	145,2	163,3	181,5	199,6	217,8	235,9	254,1	272,2	290,4

Characteristic load-carrying capacity $F_{4/5,Rk}$ (N) for two angle brackets

b / e (mm)		0	20	40	60	80	100	120	140	160	180	200	220	240	260	280	300	320
0	T	35999	35999	35999	35999	35999	35999	35999	35999	35999	35999	35999	35999	35999	35999	35999	35999	35999
	S	-	-	-	-	-	-	-	-	-	-	-	-	-	-	-	-	-
20	T	35999	23868	11934	7956	5967	4774	3978	3410	2984	2652	2387	2170	1989	1836	1705	1591	1492
	S	-	231	115	77	57	46	38	33	28	25	23	21	19	17	16	15	14
40	T	35999	36000	23868	15912	11934	9547	7956	6819	5967	5304	4774	4340	3978	3672	3410	3182	2984
	S	-	463	231	154	115	92	77	66	57	51	46	42	38	35	33	30	28
60	T	35999	36000	35802	23868	17901	14321	11934	10229	8951	7956	7160	6509	5967	5508	5115	4774	4475
	S	-	694	347	231	173	138	115	99	86	77	69	63	57	53	49	46	43
80	T	35999	36000	36000	31824	23868	19094	15912	13639	11934	10608	9547	8679	7956	7344	6819	6365	5967
	S	-	926	463	308	231	185	154	132	115	102	92	84	77	71	66	61	57
100	T	35999	36000	36000	36000	29835	23868	19890	17049	14918	13260	11934	10849	9945	9180	8524	7956	7459
	S	-	1157	578	385	289	231	192	165	144	128	115	105	96	89	82	77	72
120	T	35999	36000	36000	36000	35802	28642	23868	20458	17901	15912	14321	13019	11934	11016	10229	9547	8951
	S	-	1389	694	463	347	277	231	198	173	154	138	126	115	106	99	92	86
140	T	35999	36000	36000	36000	36000	33415	27846	23868	20885	18564	16708	15189	13923	12852	11934	11138	10442
	S	-	1620	810	540	405	324	270	231	202	180	162	147	135	124	115	108	101
160	T	35999	36000	36000	36000	36000	31824	27278	23868	21216	19094	17359	15912	14688	13639	12730	11934	11342
	S	-	1852	926	617	463	370	308	264	231	205	185	168	154	142	132	123	115
180	T	35999	36000	36000	36000	36000	35802	30687	26852	23868	21481	19528	17901	16524	15344	14321	13426	12730
	S	-	2083	1041	694	520	416	347	297	260	231	208	189	173	160	148	138	130
200	T	35999	36000	36000	36000	36000	36000	34097	29835	26520	23868	21698	19890	18360	17049	15912	14918	14182
	S	-	2315	1157	771	578	463	385	330	289	257	231	210	192	178	165	154	144
220	T	35999	36000	36000	36000	36000	36000	36000	32819	29172	26255	23868	21879	20196	18753	17503	16409	15518
	S	-	2546	1273	848	636	509	424	363	318	282	254	231	212	195	181	169	159
240	T	35999	36000	36000	36000	36000	36000	36000	35802	31824	28642	26038	23868	22032	20458	19094	17901	17001
	S	-	2778	1389	926	694	555	463	396	347	308	277	252	231	213	198	185	173
$k_1 \times b$ (-)		0,0	109,1	218,2	327,3	436,4	545,5	654,5	763,6	872,7	981,8	1090,9	1200,0	1309,1	1418,2	1527,3	1636,4	1745,5

TTM: Timber-Timber-Maximum | TTP: Timber-Timber-Partial | TCM: Timber-Concrete-Maximum | TCP: Timber-Concrete-Partial

T: $F_{1,T,Rk}$ load-carrying capacity of timber | S: $F_{1,S,Rk}$ load-carrying capacity of steel

Table B. 172 Angle bracket type 9004SA4, Variant TCP, Fastener Profiled nail A4 4x40, Density 350 kg/m³Characteristic load-carrying capacity $F_{1,Rk}$ (N) for one / two angle brackets

angle bracket		1													2
f (mm)		0	10	20	30	40	50	60	70	80	90	100	110	120	0
$F_{1,Rk}$	T	13120	900	450	300	225	180	150	129	113	100	90	82	75	26240
	S	231	173	110	73	55	44	36	31	27	24	22	20	18	462
k_1 (-)		5,5	7,3	9,1	10,9	12,7	14,5	16,4	18,2	20,0	21,8	23,6	25,5	27,3	2,7

Characteristic load-carrying capacity $F_{2/3,Rk}$ (N) for one / two angle brackets

angle bracket		1	2
$F_{2/3,Rk}$	T	4250	8500
	S	-	-

Characteristic load-carrying capacity $F_{4,Rk}$ (N) for one angle bracket

e (mm)		0	20	40	60	80	100	120	140	160	180	200	220	240	260	280	300	320
$F_{4,Rk}$	T	-	-	3600	400	212	144	109	88	73	63	55	49	44	40	37	34	32
	S	-	347	173	98	51	35	26	21	18	15	13	12	10	9	9	8	7
k_1 (-)		0,0	3,6	7,3	10,9	14,5	18,2	21,8	25,5	29,1	32,7	36,4	40,0	43,6	47,3	50,9	54,5	58,2

Characteristic load-carrying capacity $F_{5,Rk}$ (N) for one angle bracket

b / e (mm)		0	20	40	60	80	100	120	140	160	180	200	220	240	260	280	300	320
0	T	240	514	3150	2100	1575	1260	1050	900	788	700	630	573	525	485	450	420	394
	S	58	126	773	515	386	309	257	220	193	171	154	140	128	118	110	103	96
20	T	240	514	3150	2100	1575	1260	1050	900	788	700	630	573	525	485	450	420	394
	S	58	126	773	515	386	309	257	220	193	171	154	140	128	118	110	103	96
40	T	240	514	3150	2100	1575	1260	1050	900	788	700	630	573	525	485	450	420	394
	S	58	126	773	515	386	309	257	220	193	171	154	140	128	118	110	103	96
60	T	240	514	3150	2100	1575	1260	1050	900	788	700	630	573	525	485	450	420	394
	S	58	126	773	515	386	309	257	220	193	171	154	140	128	118	110	103	96
80	T	240	514	3150	2100	1575	1260	1050	900	788	700	630	573	525	485	450	420	394
	S	58	126	773	515	386	309	257	220	193	171	154	140	128	118	110	103	96
100	T	240	514	3150	2100	1575	1260	1050	900	788	700	630	573	525	485	450	420	394
	S	58	126	773	515	386	309	257	220	193	171	154	140	128	118	110	103	96
120	T	240	514	3150	2100	1575	1260	1050	900	788	700	630	573	525	485	450	420	394
	S	58	126	773	515	386	309	257	220	193	171	154	140	128	118	110	103	96
140	T	240	514	3150	2100	1575	1260	1050	900	788	700	630	573	525	485	450	420	394
	S	58	126	773	515	386	309	257	220	193	171	154	140	128	118	110	103	96
160	T	240	514	3150	2100	1575	1260	1050	900	788	700	630	573	525	485	450	420	394
	S	58	126	773	515	386	309	257	220	193	171	154	140	128	118	110	103	96
180	T	240	514	3150	2100	1575	1260	1050	900	788	700	630	573	525	485	450	420	394
	S	58	126	773	515	386	309	257	220	193	171	154	140	128	118	110	103	96
200	T	240	514	3150	2100	1575	1260	1050	900	788	700	630	573	525	485	450	420	394
	S	58	126	773	515	386	309	257	220	193	171	154	140	128	118	110	103	96
220	T	240	514	3150	2100	1575	1260	1050	900	788	700	630	573	525	485	450	420	394
	S	58	126	773	515	386	309	257	220	193	171	154	140	128	118	110	103	96
240	T	240	514	3150	2100	1575	1260	1050	900	788	700	630	573	525	485	450	420	394
	S	58	126	773	515	386	309	257	220	193	171	154	140	128	118	110	103	96
$k_1 \times b$ (-)		0,0	18,1	36,3	54,4	72,6	90,7	108,9	127,0	145,2	163,3	181,5	199,6	217,8	235,9	254,1	272,2	290,4

Characteristic load-carrying capacity $F_{4/5,Rk}$ (N) for two angle brackets

b / e (mm)		0	20	40	60	80	100	120	140	160	180	200	220	240	260	280	300	320
0	T	14400	14400	14400	14400	14400	14400	14400	14400	14400	14400	14400	14400	14400	14400	14400	14400	14400
	S	-	-	-	-	-	-	-	-	-	-	-	-	-	-	-	-	-
20	T	14400	13120	6560	4373	3280	2624	2187	1874	1640	1458	1312	1193	1093	1009	937	875	820
	S	-	231	115	77	57	46	38	33	28	25	23	21	19	17	16	15	14
40	T	14400	14400	13120	8747	6560	5248	4373	3749	3280	2916	2624	2385	2187	2018	1874	1749	1640
	S	-	463	231	154	115	92	77	66	57	51	46	42	38	35	33	30	28
60	T	14400	14400	14400	13120	9840	7872	6560	5623	4920	4373	3936	3578	3280	3028	2811	2624	2460
	S	-	694	347	231	173	138	115	99	86	77	69	63	57	53	49	46	43
80	T	14400	14400	14400	14400	13120	10496	8747	7497	6560	5831	5248	4771	4373	4037	3749	3499	3280
	S	-	926	463	308	231	185	154	132	115	102	92	84	77	71	66	61	57
100	T	14400	14400	14400	14400	14400	13120	10933	9371	8200	7289	6560	5964	5467	5046	4686	4373	4100
	S	-	1157	578	385	289	231	192	165	144	128	115	105	96	89	82	77	72
120	T	14400	14400	14400	14400	14400	14400	13120	11246	9840	8747	7872	7156	6560	6055	5623	5248	4920
	S	-	1389	694	463	347	277	231	198	173	154	138	126	115	106	99	92	86
140	T	14400	14400	14400	14400	14400	14400	13120	11480	10204	9184	8349	7653	7065	6560	6123	5740	5400
	S	-	1620	810	540	405	324	270	231	202	180	162	147	135	124	115	108	101
160	T	14400	14400	14400	14400	14400	14400	14400	13120	11662	10496	9542	8747	8074	7497	6997	6560	6200
	S	-	1852	926	617	463	370	308	264	231	205	185	168	154	142	132	123	115
180	T	14400	14400	14400	14400	14400	14400	14400	14400	13120	11808	10735	9840	9083	8434	7872	7380	7000
	S	-	2083	1041	694	520	416	347	297	260	231	208	189	173	160	148	138	130
200	T	14400	14400	14400	14400	14400	14400	14400	14400	14400	14400	13120	11927	10933	10092	9371	8747	8200
	S	-	2315	1157	771	578	463	385	330	289	257	231	210	192	178	165	154	144
220	T	14400	14400	14400	14400	14400	14400	14400	14400	14400	14400	14400	13120	12027	11102	10309	9621	9020
	S	-	2546	1273	848	636	509	424	363	318	282	254	231	212	195	181	169	159
240	T	14400	14400	14400	14400	14400	14400	14400	14400	14400	14400	14400	14400	14313	13120	12111	11246	10496
	S	-	2778	1389	926	694	555	463	396	347	308	277	252	231	213	198	185	173
$k_1 \times b$ (-)		0,0	109,1	218,2	327,3	436,4	545,5	654,5	763,6	872,7	981,8	1090,9	1200,0	1309,1	1418,2	1527,3	1636,4	1745,5

TTM: Timber-Timber-Maximum | TTP: Timber-Timber-Partial | TCM: Timber-Concrete-Maximum | TCP: Timber-Concrete-Partial

T: $F_{1,T,Rk}$ load-carrying capacity of timber | S: $F_{1,S,Rk}$ load-carrying capacity of steel

Table B. 173 Angle bracket type 9004SA4, Variant TCP, Fastener Profiled nail A4 4x60, Density 350 kg/m³Characteristic load-carrying capacity $F_{1,Rk}$ (N) for one / two angle brackets

angle bracket	1													2	
f (mm)	0	10	20	30	40	50	60	70	80	90	100	110	120	0	
$F_{1,Rk}$	T	15912	1500	750	500	375	300	250	214	188	167	150	136	125	31824
	S	231	173	110	73	55	44	36	31	27	24	22	20	18	
k_1 (-)	5,5	7,3	9,1	10,9	12,7	14,5	16,4	18,2	20,0	21,8	23,6	25,5	27,3	2,7	

Characteristic load-carrying capacity $F_{2/3,Rk}$ (N) for one / two angle brackets

angle bracket	1	2	
$F_{2/3,Rk}$	T	5500	11000
	S	-	-

Characteristic load-carrying capacity $F_{4,Rk}$ (N) for one angle bracket

e (mm)	0	20	40	60	80	100	120	140	160	180	200	220	240	260	280	300	320	
$F_{4,Rk}$	T	-	-	6000	667	353	240	182	146	122	105	92	82	74	67	62	57	53
	S	-	347	173	98	51	35	26	21	18	15	13	12	10	9	9	8	7
k_1 (-)	0,0	3,6	7,3	10,9	14,5	18,2	21,8	25,5	29,1	32,7	36,4	40,0	43,6	47,3	50,9	54,5	58,2	

Characteristic load-carrying capacity $F_{5,Rk}$ (N) for one angle bracket

b / e (mm)	0	20	40	60	80	100	120	140	160	180	200	220	240	260	280	300	320	
0	T	400	857	5250	3500	2625	2100	1750	1500	1313	1167	1050	955	875	808	750	700	656
	S	58	126	773	515	386	309	257	220	193	171	154	140	128	118	110	103	96
20	T	400	857	5250	3500	2625	2100	1750	1500	1313	1167	1050	955	875	808	750	700	656
	S	58	126	773	515	386	309	257	220	193	171	154	140	128	118	110	103	96
40	T	400	857	5250	3500	2625	2100	1750	1500	1313	1167	1050	955	875	808	750	700	656
	S	58	126	773	515	386	309	257	220	193	171	154	140	128	118	110	103	96
60	T	400	857	5250	3500	2625	2100	1750	1500	1313	1167	1050	955	875	808	750	700	656
	S	58	126	773	515	386	309	257	220	193	171	154	140	128	118	110	103	96
80	T	400	857	5250	3500	2625	2100	1750	1500	1313	1167	1050	955	875	808	750	700	656
	S	58	126	773	515	386	309	257	220	193	171	154	140	128	118	110	103	96
100	T	400	857	5250	3500	2625	2100	1750	1500	1313	1167	1050	955	875	808	750	700	656
	S	58	126	773	515	386	309	257	220	193	171	154	140	128	118	110	103	96
120	T	400	857	5250	3500	2625	2100	1750	1500	1313	1167	1050	955	875	808	750	700	656
	S	58	126	773	515	386	309	257	220	193	171	154	140	128	118	110	103	96
140	T	400	857	5250	3500	2625	2100	1750	1500	1313	1167	1050	955	875	808	750	700	656
	S	58	126	773	515	386	309	257	220	193	171	154	140	128	118	110	103	96
160	T	400	857	5250	3500	2625	2100	1750	1500	1313	1167	1050	955	875	808	750	700	656
	S	58	126	773	515	386	309	257	220	193	171	154	140	128	118	110	103	96
180	T	400	857	5250	3500	2625	2100	1750	1500	1313	1167	1050	955	875	808	750	700	656
	S	58	126	773	515	386	309	257	220	193	171	154	140	128	118	110	103	96
200	T	400	857	5250	3500	2625	2100	1750	1500	1313	1167	1050	955	875	808	750	700	656
	S	58	126	773	515	386	309	257	220	193	171	154	140	128	118	110	103	96
220	T	400	857	5250	3500	2625	2100	1750	1500	1313	1167	1050	955	875	808	750	700	656
	S	58	126	773	515	386	309	257	220	193	171	154	140	128	118	110	103	96
240	T	400	857	5250	3500	2625	2100	1750	1500	1313	1167	1050	955	875	808	750	700	656
	S	58	126	773	515	386	309	257	220	193	171	154	140	128	118	110	103	96
$k_1 \times b$ (-)	0,0	18,1	36,3	54,4	72,6	90,7	108,9	127,0	145,2	163,3	181,5	199,6	217,8	235,9	254,1	272,2	290,4	

Characteristic load-carrying capacity $F_{4/5,Rk}$ (N) for two angle brackets

b / e (mm)	0	20	40	60	80	100	120	140	160	180	200	220	240	260	280	300	320	
0	T	23999	23999	23999	23999	23999	23999	23999	23999	23999	23999	23999	23999	23999	23999	23999	23999	
	S	-	-	-	-	-	-	-	-	-	-	-	-	-	-	-	-	
20	T	23999	15912	7956	5304	3978	3182	2652	2273	1989	1768	1591	1447	1326	1224	1137	1061	995
	S	-	231	115	77	57	46	38	33	28	25	23	21	19	17	16	15	14
40	T	23999	24000	15912	10608	7956	6365	5304	4546	3978	3536	3182	2893	2652	2448	2273	2122	1989
	S	-	463	231	154	115	92	77	66	57	51	46	42	38	35	33	30	28
60	T	23999	24000	23868	15912	11934	9547	7956	6819	5967	5304	4774	4340	3978	3672	3410	3182	2984
	S	-	694	347	231	173	138	115	99	86	77	69	63	57	53	49	46	43
80	T	23999	24000	24000	21216	15912	12730	10608	9093	7956	7072	6365	5786	5304	4896	4546	4243	3978
	S	-	926	463	308	231	185	154	132	115	102	92	84	77	71	66	61	57
100	T	23999	24000	24000	24000	19890	15912	13260	11366	9945	8840	7956	7233	6630	6120	5683	5304	4973
	S	-	1157	578	385	289	231	192	165	144	128	115	105	96	89	82	77	72
120	T	23999	24000	24000	24000	23868	19094	15912	13639	11934	10608	9547	8679	7956	7344	6819	6365	5967
	S	-	1389	694	463	347	277	231	198	173	154	138	126	115	106	99	92	86
140	T	23999	24000	24000	24000	24000	22277	18564	15912	13923	12376	11138	10126	9282	8568	7956	7426	6962
	S	-	1620	810	540	405	324	270	231	202	180	162	147	135	124	115	108	101
160	T	23999	24000	24000	24000	24000	21216	18185	15912	14144	12730	11572	10608	9792	9093	8486	7956	
	S	-	1852	926	617	463	370	308	264	231	205	185	168	154	142	132	123	115
180	T	23999	24000	24000	24000	24000	23868	20458	17901	15912	14321	13019	11934	11016	10229	9547	8951	
	S	-	2083	1041	694	520	416	347	297	260	231	208	189	173	160	148	138	130
200	T	23999	24000	24000	24000	24000	24000	22731	19890	17680	15912	14465	13260	12240	11366	10608	9945	
	S	-	2315	1157	771	578	463	385	330	289	257	231	210	192	178	165	154	144
220	T	23999	24000	24000	24000	24000	24000	24000	21879	19448	17503	15912	14586	13464	12502	11669	10940	
	S	-	2546	1273	848	636	509	424	363	318	282	254	231	212	195	181	169	159
240	T	23999	24000	24000	24000	24000	24000	24000	23868	21216	19094	17359	15912	14688	13639	12730	11934	
	S	-	2778	1389	926	694	555	463	396	347	308	277	252	231	213	198	185	173
$k_1 \times b$ (-)	0,0	109,1	218,2	327,3	436,4	545,5	654,5	763,6	872,7	981,8	1090,9	1200,0	1309,1	1418,2	1527,3	1636,4	1745,5	

TTM: Timber-Timber-Maximum | TTP: Timber-Timber-Partial | TCM: Timber-Concrete-Maximum | TCP: Timber-Concrete-Partial

T: $F_{1,T,Rk}$ load-carrying capacity of timber | S: $F_{1,S,Rk}$ load-carrying capacity of steel

Table B. 174 Angle bracket type 9004SA4, Variant TTM, Fastener Profiled nail A4 4x40, Density 350 kg/m³Characteristic load-carrying capacity $F_{1,Rk}$ (N) for one / two angle brackets

angle bracket		1													2
f (mm)		0	10	20	30	40	50	60	70	80	90	100	110	120	0
$F_{1,Rk}$	T	225	150	113	90	75	64	56	50	45	41	38	35	32	450
	S	220	147	110	73	55	44	36	31	27	24	22	20	18	440

Characteristic load-carrying capacity $F_{2/3,Rk}$ (N) for one / two angle brackets

angle bracket		1	2
$F_{2/3,Rk}$	T	7620	15240
	S	-	-

Characteristic load-carrying capacity $F_{4,Rk}$ (N) for one angle bracket

e (mm)		0	20	40	60	80	100	120	140	160	180	200	220	240	260	280	300	320
$F_{4,Rk}$	T	22959	225	113	75	56	45	38	32	28	25	23	20	19	17	16	15	14
	S	-	220	110	73	51	35	26	21	18	15	13	12	10	9	9	8	7

Characteristic load-carrying capacity $F_{5,Rk}$ (N) for one angle bracket

b / e (mm)		0	20	40	60	80	100	120	140	160	180	200	220	240	260	280	300	320
0	T	240	514	788	525	394	315	263	225	197	175	158	143	131	121	113	105	98
	S	58	126	773	515	386	309	257	220	193	171	154	140	128	118	110	103	96
20	T	240	514	1688	1125	844	675	563	482	422	375	338	307	281	260	241	225	211
	S	58	126	773	515	386	309	257	220	193	171	154	140	128	118	110	103	96
40	T	240	514	2588	1725	1294	1035	863	739	647	575	518	470	431	398	370	345	323
	S	58	126	773	515	386	309	257	220	193	171	154	140	128	118	110	103	96
60	T	240	514	3150	2100	1575	1260	1050	900	788	700	630	573	525	485	450	420	394
	S	58	126	773	515	386	309	257	220	193	171	154	140	128	118	110	103	96
80	T	240	514	3150	2100	1575	1260	1050	900	788	700	630	573	525	485	450	420	394
	S	58	126	773	515	386	309	257	220	193	171	154	140	128	118	110	103	96
100	T	240	514	3150	2100	1575	1260	1050	900	788	700	630	573	525	485	450	420	394
	S	58	126	773	515	386	309	257	220	193	171	154	140	128	118	110	103	96
120	T	240	514	3150	2100	1575	1260	1050	900	788	700	630	573	525	485	450	420	394
	S	58	126	773	515	386	309	257	220	193	171	154	140	128	118	110	103	96
140	T	240	514	3150	2100	1575	1260	1050	900	788	700	630	573	525	485	450	420	394
	S	58	126	773	515	386	309	257	220	193	171	154	140	128	118	110	103	96
160	T	240	514	3150	2100	1575	1260	1050	900	788	700	630	573	525	485	450	420	394
	S	58	126	773	515	386	309	257	220	193	171	154	140	128	118	110	103	96
180	T	240	514	3150	2100	1575	1260	1050	900	788	700	630	573	525	485	450	420	394
	S	58	126	773	515	386	309	257	220	193	171	154	140	128	118	110	103	96
200	T	240	514	3150	2100	1575	1260	1050	900	788	700	630	573	525	485	450	420	394
	S	58	126	773	515	386	309	257	220	193	171	154	140	128	118	110	103	96
220	T	240	514	3150	2100	1575	1260	1050	900	788	700	630	573	525	485	450	420	394
	S	58	126	773	515	386	309	257	220	193	171	154	140	128	118	110	103	96
240	T	240	514	3150	2100	1575	1260	1050	900	788	700	630	573	525	485	450	420	394
	S	58	126	773	515	386	309	257	220	193	171	154	140	128	118	110	103	96

Characteristic load-carrying capacity $F_{4/5,Rk}$ (N) for two angle brackets

b / e (mm)		0	20	40	60	80	100	120	140	160	180	200	220	240	260	280	300	320
0	T	21599	21599	21599	21599	21599	21599	21599	21599	21599	21599	21599	21599	21599	21599	21599	21599	21599
	S	-	-	-	-	-	-	-	-	-	-	-	-	-	-	-	-	-
20	T	21599	225	113	75	56	45	38	32	28	25	23	20	19	17	16	15	14
	S	-	220	110	73	55	44	36	31	27	24	22	20	18	16	15	14	13
40	T	21599	450	225	150	113	90	75	64	56	50	45	41	38	35	32	30	28
	S	-	441	220	147	110	88	73	63	55	49	44	40	36	33	31	29	27
60	T	21599	675	338	225	169	135	113	96	84	75	68	61	56	52	48	45	42
	S	-	662	331	220	165	132	110	94	82	73	66	60	55	50	47	44	41
80	T	21599	900	450	300	225	180	150	129	113	100	90	82	75	69	64	60	56
	S	-	883	441	294	220	176	147	126	110	98	88	80	73	67	63	58	55
100	T	21599	1125	563	375	281	225	188	161	141	125	113	102	94	87	80	75	70
	S	-	1104	552	368	276	220	184	157	138	122	110	100	92	84	78	73	69
120	T	21599	1350	675	450	338	270	225	193	169	150	135	123	113	104	96	90	84
	S	-	1325	662	441	331	265	220	189	165	147	132	120	110	101	94	88	82
140	T	21599	1575	788	525	394	315	263	225	197	175	158	143	131	121	113	105	98
	S	-	1546	773	515	386	309	257	220	193	171	154	140	128	118	110	103	96
160	T	21599	1800	900	600	450	360	300	257	225	200	180	164	150	138	129	120	113
	S	-	1767	883	589	441	353	294	252	220	196	176	160	147	135	126	117	110
180	T	21599	2025	1013	675	506	405	338	289	253	225	203	184	169	156	145	135	127
	S	-	1988	994	662	497	397	331	284	248	220	198	180	165	152	142	132	124
200	T	21599	2250	1125	750	563	450	375	321	281	250	225	205	188	173	161	150	141
	S	-	2209	1104	736	552	441	368	315	276	245	220	200	184	169	157	147	138
220	T	21599	2475	1238	825	619	495	413	354	309	275	248	225	206	190	177	165	155
	S	-	2430	1215	810	607	486	405	347	303	270	243	220	202	186	173	162	151
240	T	21599	2700	1350	900	675	540	450	386	338	300	270	245	225	208	193	180	169
	S	-	2651	1325	883	662	530	441	378	331	294	265	241	220	203	189	176	165

TTM: Timber-Timber-Maximum | TTP: Timber-Timber-Partial | TCM: Timber-Concrete-Maximum | TCP: Timber-Concrete-Partial

T: $F_{1,T,Rk}$ load-carrying capacity of timber | S: $F_{1,S,Rk}$ load-carrying capacity of steel

Table B. 175 Angle bracket type 9004SA4, Variant TTM, Fastener Profiled nail A4 4x60, Density 350 kg/m³Characteristic load-carrying capacity $F_{T,Rk}$ (N) for one / two angle brackets

angle bracket		1													2
f (mm)		0	10	20	30	40	50	60	70	80	90	100	110	120	0
$F_{T,Rk}$	T	375	250	188	150	125	107	94	83	75	68	63	58	54	750
	S	220	147	110	73	55	44	36	31	27	24	22	20	18	440

Characteristic load-carrying capacity $F_{2/3,Rk}$ (N) for one / two angle brackets

angle bracket		1	2
$F_{2/3,Rk}$	T	9440	18880
	S	-	-

Characteristic load-carrying capacity $F_{4,Rk}$ (N) for one angle bracket

e (mm)		0	20	40	60	80	100	120	140	160	180	200	220	240	260	280	300	320
$F_{4,Rk}$	T	27845	375	188	125	94	75	63	54	47	42	38	34	31	29	27	25	23
	S	-	220	110	73	51	35	26	21	18	15	13	12	10	9	9	8	7

Characteristic load-carrying capacity $F_{5,Rk}$ (N) for one angle bracket

b / e (mm)		0	20	40	60	80	100	120	140	160	180	200	220	240	260	280	300	320
0	T	400	857	1313	875	656	525	438	375	328	292	263	239	219	202	188	175	164
	S	58	126	773	515	386	309	257	220	193	171	154	140	128	118	110	103	96
20	T	400	857	2813	1875	1406	1125	938	804	703	625	563	511	469	433	402	375	352
	S	58	126	773	515	386	309	257	220	193	171	154	140	128	118	110	103	96
40	T	400	857	4313	2875	2156	1725	1438	1232	1078	958	863	784	719	663	616	575	539
	S	58	126	773	515	386	309	257	220	193	171	154	140	128	118	110	103	96
60	T	400	857	5250	3500	2625	2100	1750	1500	1313	1167	1050	955	875	808	750	700	656
	S	58	126	773	515	386	309	257	220	193	171	154	140	128	118	110	103	96
80	T	400	857	5250	3500	2625	2100	1750	1500	1313	1167	1050	955	875	808	750	700	656
	S	58	126	773	515	386	309	257	220	193	171	154	140	128	118	110	103	96
100	T	400	857	5250	3500	2625	2100	1750	1500	1313	1167	1050	955	875	808	750	700	656
	S	58	126	773	515	386	309	257	220	193	171	154	140	128	118	110	103	96
120	T	400	857	5250	3500	2625	2100	1750	1500	1313	1167	1050	955	875	808	750	700	656
	S	58	126	773	515	386	309	257	220	193	171	154	140	128	118	110	103	96
140	T	400	857	5250	3500	2625	2100	1750	1500	1313	1167	1050	955	875	808	750	700	656
	S	58	126	773	515	386	309	257	220	193	171	154	140	128	118	110	103	96
160	T	400	857	5250	3500	2625	2100	1750	1500	1313	1167	1050	955	875	808	750	700	656
	S	58	126	773	515	386	309	257	220	193	171	154	140	128	118	110	103	96
180	T	400	857	5250	3500	2625	2100	1750	1500	1313	1167	1050	955	875	808	750	700	656
	S	58	126	773	515	386	309	257	220	193	171	154	140	128	118	110	103	96
200	T	400	857	5250	3500	2625	2100	1750	1500	1313	1167	1050	955	875	808	750	700	656
	S	58	126	773	515	386	309	257	220	193	171	154	140	128	118	110	103	96
220	T	400	857	5250	3500	2625	2100	1750	1500	1313	1167	1050	955	875	808	750	700	656
	S	58	126	773	515	386	309	257	220	193	171	154	140	128	118	110	103	96
240	T	400	857	5250	3500	2625	2100	1750	1500	1313	1167	1050	955	875	808	750	700	656
	S	58	126	773	515	386	309	257	220	193	171	154	140	128	118	110	103	96

Characteristic load-carrying capacity $F_{4/5,Rk}$ (N) for two angle brackets

b / e (mm)		0	20	40	60	80	100	120	140	160	180	200	220	240	260	280	300	320
0	T	35999	35999	35999	35999	35999	35999	35999	35999	35999	35999	35999	35999	35999	35999	35999	35999	35999
	S	-	-	-	-	-	-	-	-	-	-	-	-	-	-	-	-	-
20	T	35999	375	188	125	94	75	63	54	47	42	38	34	31	29	27	25	23
	S	-	220	110	73	55	44	36	31	27	24	22	20	18	16	15	14	13
40	T	35999	750	375	250	188	150	125	107	94	83	75	68	63	58	54	50	47
	S	-	441	220	147	110	88	73	63	55	49	44	40	36	33	31	29	27
60	T	35999	1125	563	375	281	225	188	161	141	125	113	102	94	87	80	75	70
	S	-	662	331	220	165	132	110	94	82	73	66	60	55	50	47	44	41
80	T	35999	1500	750	500	375	300	250	214	188	167	150	136	125	115	107	100	94
	S	-	883	441	294	220	176	147	126	110	98	88	80	73	67	63	58	55
100	T	35999	1875	938	625	469	375	313	268	234	208	188	170	156	144	134	125	117
	S	-	1104	552	368	276	220	184	157	138	122	110	100	92	84	78	73	69
120	T	35999	2250	1125	750	563	450	375	321	281	250	225	205	188	173	161	150	141
	S	-	1325	662	441	331	265	220	189	165	147	132	120	110	101	94	88	82
140	T	35999	2625	1313	875	656	525	438	375	328	292	263	239	219	202	188	175	164
	S	-	1546	773	515	386	309	257	220	193	171	154	140	128	118	110	103	96
160	T	35999	3000	1500	1000	750	600	500	429	375	333	300	273	250	231	214	200	188
	S	-	1767	883	589	441	353	294	252	220	196	176	160	147	135	126	117	110
180	T	35999	3375	1688	1125	844	675	563	482	422	375	338	307	281	260	241	225	211
	S	-	1988	994	662	497	397	331	284	248	220	198	180	165	152	142	132	124
200	T	35999	3750	1875	1250	938	750	625	536	469	417	375	341	313	288	268	250	234
	S	-	2209	1104	736	552	441	368	315	276	245	220	200	184	169	157	147	138
220	T	35999	4125	2063	1375	1031	825	688	589	516	458	413	375	344	317	295	275	258
	S	-	2430	1215	810	607	486	405	347	303	270	243	220	202	186	173	162	151
240	T	35999	4500	2250	1500	1125	900	750	643	563	500	450	409	375	346	321	300	281
	S	-	2651	1325	883	662	530	441	378	331	294	265	241	220	203	189	176	165

TTM: Timber-Timber-Maximum | TTP: Timber-Timber-Partial | TCM: Timber-Concrete-Maximum | TCP: Timber-Concrete-Partial

T: $F_{T,Rk}$ load-carrying capacity of timber | S: $F_{S,Rk}$ load-carrying capacity of steel

Table B. 176 Angle bracket type 9004SA4, Variant TTP, Fastener Profiled nail A4 4x40, Density 350 kg/m³Characteristic load-carrying capacity $F_{1,Rk}$ (N) for one / two angle brackets

angle bracket		1												2	
f (mm)		0	10	20	30	40	50	60	70	80	90	100	110	120	0
$F_{1,Rk}$	T	225	150	113	90	75	64	56	50	45	41	38	35	32	450
	S	220	147	110	73	55	44	36	31	27	24	22	20	18	440

Characteristic load-carrying capacity $F_{2/3,Rk}$ (N) for one / two angle brackets

angle bracket		1	2
$F_{2/3,Rk}$	T	4690	9380
	S	-	-

Characteristic load-carrying capacity $F_{4,Rk}$ (N) for one angle bracket

e (mm)		0	20	40	60	80	100	120	140	160	180	200	220	240	260	280	300	320
$F_{4,Rk}$	T	9840	225	113	75	56	45	38	32	28	25	23	20	19	17	16	15	14
	S	-	220	110	73	51	35	26	21	18	15	13	12	10	9	9	8	7

Characteristic load-carrying capacity $F_{5,Rk}$ (N) for one angle bracket

b / e (mm)		0	20	40	60	80	100	120	140	160	180	200	220	240	260	280	300	320
0	T	240	514	788	525	394	315	263	225	197	175	158	143	131	121	113	105	98
	S	58	126	773	515	386	309	257	220	193	171	154	140	128	118	110	103	96
20	T	240	514	1688	1125	844	675	563	482	422	375	338	307	281	260	241	225	211
	S	58	126	773	515	386	309	257	220	193	171	154	140	128	118	110	103	96
40	T	240	514	2588	1725	1294	1035	863	739	647	575	518	470	431	398	370	345	323
	S	58	126	773	515	386	309	257	220	193	171	154	140	128	118	110	103	96
60	T	240	514	3150	2100	1575	1260	1050	900	788	700	630	573	525	485	450	420	394
	S	58	126	773	515	386	309	257	220	193	171	154	140	128	118	110	103	96
80	T	240	514	3150	2100	1575	1260	1050	900	788	700	630	573	525	485	450	420	394
	S	58	126	773	515	386	309	257	220	193	171	154	140	128	118	110	103	96
100	T	240	514	3150	2100	1575	1260	1050	900	788	700	630	573	525	485	450	420	394
	S	58	126	773	515	386	309	257	220	193	171	154	140	128	118	110	103	96
120	T	240	514	3150	2100	1575	1260	1050	900	788	700	630	573	525	485	450	420	394
	S	58	126	773	515	386	309	257	220	193	171	154	140	128	118	110	103	96
140	T	240	514	3150	2100	1575	1260	1050	900	788	700	630	573	525	485	450	420	394
	S	58	126	773	515	386	309	257	220	193	171	154	140	128	118	110	103	96
160	T	240	514	3150	2100	1575	1260	1050	900	788	700	630	573	525	485	450	420	394
	S	58	126	773	515	386	309	257	220	193	171	154	140	128	118	110	103	96
180	T	240	514	3150	2100	1575	1260	1050	900	788	700	630	573	525	485	450	420	394
	S	58	126	773	515	386	309	257	220	193	171	154	140	128	118	110	103	96
200	T	240	514	3150	2100	1575	1260	1050	900	788	700	630	573	525	485	450	420	394
	S	58	126	773	515	386	309	257	220	193	171	154	140	128	118	110	103	96
220	T	240	514	3150	2100	1575	1260	1050	900	788	700	630	573	525	485	450	420	394
	S	58	126	773	515	386	309	257	220	193	171	154	140	128	118	110	103	96
240	T	240	514	3150	2100	1575	1260	1050	900	788	700	630	573	525	485	450	420	394
	S	58	126	773	515	386	309	257	220	193	171	154	140	128	118	110	103	96

Characteristic load-carrying capacity $F_{4/5,Rk}$ (N) for two angle brackets

b / e (mm)		0	20	40	60	80	100	120	140	160	180	200	220	240	260	280	300	320
0	T	14400	14400	14400	14400	14400	14400	14400	14400	14400	14400	14400	14400	14400	14400	14400	14400	14400
	S	-	-	-	-	-	-	-	-	-	-	-	-	-	-	-	-	-
20	T	14400	225	113	75	56	45	38	32	28	25	23	20	19	17	16	15	14
	S	-	220	110	73	55	44	36	31	27	24	22	20	18	16	15	14	13
40	T	14400	450	225	150	113	90	75	64	56	50	45	41	38	35	32	30	28
	S	-	441	220	147	110	88	73	63	55	49	44	40	36	33	31	29	27
60	T	14400	675	338	225	169	135	113	96	84	75	68	61	56	52	48	45	42
	S	-	662	331	220	165	132	110	94	82	73	66	60	55	50	47	44	41
80	T	14400	900	450	300	225	180	150	129	113	100	90	82	75	69	64	60	56
	S	-	883	441	294	220	176	147	126	110	98	88	80	73	67	63	58	55
100	T	14400	1125	563	375	281	225	188	161	141	125	113	102	94	87	80	75	70
	S	-	1104	552	368	276	220	184	157	138	122	110	100	92	84	78	73	69
120	T	14400	1350	675	450	338	270	225	193	169	150	135	123	113	104	96	90	84
	S	-	1325	662	441	331	265	220	189	165	147	132	120	110	101	94	88	82
140	T	14400	1575	788	525	394	315	263	225	197	175	158	143	131	121	113	105	98
	S	-	1546	773	515	386	309	257	220	193	171	154	140	128	118	110	103	96
160	T	14400	1800	900	600	450	360	300	257	225	200	180	164	150	138	129	120	113
	S	-	1767	883	589	441	353	294	252	220	196	176	160	147	135	126	117	110
180	T	14400	2025	1013	675	506	405	338	289	253	225	203	184	169	156	145	135	127
	S	-	1988	994	662	497	397	331	284	248	220	198	180	165	152	142	132	124
200	T	14400	2250	1125	750	563	450	375	321	281	250	225	205	188	173	161	150	141
	S	-	2209	1104	736	552	441	368	315	276	245	220	200	184	169	157	147	138
220	T	14400	2475	1238	825	619	495	413	354	309	275	248	225	206	190	177	165	155
	S	-	2430	1215	810	607	486	405	347	303	270	243	220	202	186	173	162	151
240	T	14400	2699	1350	900	675	540	450	386	338	300	270	245	225	208	193	180	169
	S	-	2651	1325	883	662	530	441	378	331	294	265	241	220	203	189	176	165

TTM: Timber-Timber-Maximum | TTP: Timber-Timber-Partial | TCM: Timber-Concrete-Maximum | TCP: Timber-Concrete-Partial

T: $F_{1,T,Rk}$ load-carrying capacity of timber | S: $F_{1,S,Rk}$ load-carrying capacity of steel

Table B. 177 Angle bracket type 9004SA4, Variant TTP, Fastener Profiled nail A4 4x60, Density 350 kg/m³Characteristic load-carrying capacity $F_{1,Rk}$ (N) for one / two angle brackets

angle bracket		1													2
f (mm)		0	10	20	30	40	50	60	70	80	90	100	110	120	0
$F_{1,Rk}$	T	375	250	188	150	125	107	94	83	75	68	63	58	54	750
	S	220	147	110	73	55	44	36	31	27	24	22	20	18	440

Characteristic load-carrying capacity $F_{2/3,Rk}$ (N) for one / two angle brackets

angle bracket		1	2
$F_{2/3,Rk}$	T	5690	11380
	S	-	-

Characteristic load-carrying capacity $F_{4,Rk}$ (N) for one angle bracket

e (mm)		0	20	40	60	80	100	120	140	160	180	200	220	240	260	280	300	320
$F_{4,Rk}$	T	11934	375	188	125	94	75	63	54	47	42	38	34	31	29	27	25	23
	S	-	220	110	73	51	35	26	21	18	15	13	12	10	9	9	8	7

Characteristic load-carrying capacity $F_{5,Rk}$ (N) for one angle bracket

b / e (mm)		0	20	40	60	80	100	120	140	160	180	200	220	240	260	280	300	320
0	T	400	857	1313	875	656	525	438	375	328	292	263	239	219	202	188	175	164
	S	58	126	773	515	386	309	257	220	193	171	154	140	128	118	110	103	96
20	T	400	857	2813	1875	1406	1125	938	804	703	625	563	511	469	433	402	375	352
	S	58	126	773	515	386	309	257	220	193	171	154	140	128	118	110	103	96
40	T	400	857	4313	2875	2156	1725	1438	1232	1078	958	863	784	719	663	616	575	539
	S	58	126	773	515	386	309	257	220	193	171	154	140	128	118	110	103	96
60	T	400	857	5250	3500	2625	2100	1750	1500	1313	1167	1050	955	875	808	750	700	656
	S	58	126	773	515	386	309	257	220	193	171	154	140	128	118	110	103	96
80	T	400	857	5250	3500	2625	2100	1750	1500	1313	1167	1050	955	875	808	750	700	656
	S	58	126	773	515	386	309	257	220	193	171	154	140	128	118	110	103	96
100	T	400	857	5250	3500	2625	2100	1750	1500	1313	1167	1050	955	875	808	750	700	656
	S	58	126	773	515	386	309	257	220	193	171	154	140	128	118	110	103	96
120	T	400	857	5250	3500	2625	2100	1750	1500	1313	1167	1050	955	875	808	750	700	656
	S	58	126	773	515	386	309	257	220	193	171	154	140	128	118	110	103	96
140	T	400	857	5250	3500	2625	2100	1750	1500	1313	1167	1050	955	875	808	750	700	656
	S	58	126	773	515	386	309	257	220	193	171	154	140	128	118	110	103	96
160	T	400	857	5250	3500	2625	2100	1750	1500	1313	1167	1050	955	875	808	750	700	656
	S	58	126	773	515	386	309	257	220	193	171	154	140	128	118	110	103	96
180	T	400	857	5250	3500	2625	2100	1750	1500	1313	1167	1050	955	875	808	750	700	656
	S	58	126	773	515	386	309	257	220	193	171	154	140	128	118	110	103	96
200	T	400	857	5250	3500	2625	2100	1750	1500	1313	1167	1050	955	875	808	750	700	656
	S	58	126	773	515	386	309	257	220	193	171	154	140	128	118	110	103	96
220	T	400	857	5250	3500	2625	2100	1750	1500	1313	1167	1050	955	875	808	750	700	656
	S	58	126	773	515	386	309	257	220	193	171	154	140	128	118	110	103	96
240	T	400	857	5250	3500	2625	2100	1750	1500	1313	1167	1050	955	875	808	750	700	656
	S	58	126	773	515	386	309	257	220	193	171	154	140	128	118	110	103	96

Characteristic load-carrying capacity $F_{4/5,Rk}$ (N) for two angle brackets

b / e (mm)		0	20	40	60	80	100	120	140	160	180	200	220	240	260	280	300	320
0	T	23867	23867	23867	23867	23867	23867	23867	23867	23867	23867	23867	23867	23867	23867	23867	23867	23867
	S	-	-	-	-	-	-	-	-	-	-	-	-	-	-	-	-	-
20	T	23867	375	188	125	94	75	63	54	47	42	38	34	31	29	27	25	23
	S	-	220	110	73	55	44	36	31	27	24	22	20	18	16	15	14	13
40	T	23867	750	375	250	188	150	125	107	94	83	75	68	63	58	54	50	47
	S	-	441	220	147	110	88	73	63	55	49	44	40	36	33	31	29	27
60	T	23867	1125	563	375	281	225	188	161	141	125	113	102	94	87	80	75	70
	S	-	662	331	220	165	132	110	94	82	73	66	60	55	50	47	44	41
80	T	23867	1500	750	500	375	300	250	214	188	167	150	136	125	115	107	100	94
	S	-	883	441	294	220	176	147	126	110	98	88	80	73	67	63	58	55
100	T	23867	1875	938	625	469	375	313	268	234	208	188	170	156	144	134	125	117
	S	-	1104	552	368	276	220	184	157	138	122	110	100	92	84	78	73	69
120	T	23867	2250	1125	750	563	450	375	321	281	250	225	205	188	173	161	150	141
	S	-	1325	662	441	331	265	220	189	165	147	132	120	110	101	94	88	82
140	T	23867	2625	1313	875	656	525	438	375	328	292	263	239	219	202	188	175	164
	S	-	1546	773	515	386	309	257	220	193	171	154	140	128	118	110	103	96
160	T	23867	3000	1500	1000	750	600	500	429	375	333	300	273	250	231	214	200	188
	S	-	1767	883	589	441	353	294	252	220	196	176	160	147	135	126	117	110
180	T	23867	3375	1688	1125	844	675	563	482	422	375	338	307	281	260	241	225	211
	S	-	1988	994	662	497	397	331	284	248	220	198	180	165	152	142	132	124
200	T	23867	3750	1875	1250	938	750	625	536	469	417	375	341	313	288	268	250	234
	S	-	2209	1104	736	552	441	368	315	276	245	220	200	184	169	157	147	138
220	T	23867	4125	2063	1375	1031	825	688	589	516	458	413	375	344	317	295	275	258
	S	-	2430	1215	810	607	486	405	347	303	270	243	220	202	186	173	162	151
240	T	23867	4500	2250	1500	1125	900	750	643	563	500	450	409	375	346	321	300	281
	S	-	2651	1325	883	662	530	441	378	331	294	265	241	220	203	189	176	165

TTM: Timber-Timber-Maximum | TTP: Timber-Timber-Partial | TCM: Timber-Concrete-Maximum | TCP: Timber-Concrete-Partial

T: $F_{1,T,Rk}$ load-carrying capacity of timber | S: $F_{1,S,Rk}$ load-carrying capacity of steel